

Dip and coded rotary switches



Section F

P36 (CR36)	Low profile coded rotary, SMT or through-hole	F 3
PT65 (CR65)	Coded rotary, through-hole	F 5
DS/DSR	Standard DIP	F 8
DP/DPL	Piano DIP	F 10
DA	Right angle DIP	F 11
IKN	Low profile DIP, SMT or through-hole	F 12
IKD	DIP, SMT or through-hole	F 15
IKH	Half pitch DIP, SMT, very low profile	F 17

Selection guide

ermec@ermec.com

Dip and coded rotary switches

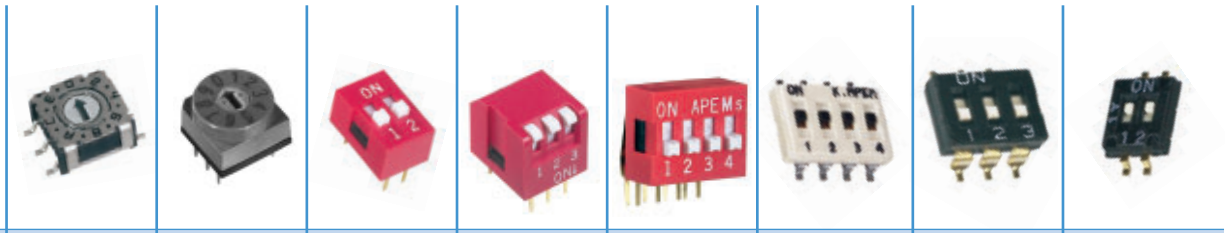

Series	P36 (CR36)	PT65 (CR65)	DS-DSR	DP-DPL	DA	IKN	IKD	IKH
Type	Coded rotary		DIP					
Page	F-3	F-5	F-8	F-10	F-11	F-12	F-15	F-17
Number of positions	10 & 16	10 & 16	2-12 (except 11)	2-12 (except 11)	2-12 (except 11)	2-8 (even only)	1-12 (except 11)	2-10 (even only)
Maximum ratings	400mA 24VDC	400mA 24VDC	100mA 50VDC	100mA 50VDC	100mA 50VDC	100mA 48VDC	100mA 50VDC	100mA 50VDC
Process Sealed	Yes	Yes	W. optional tape	W. optional tape	W. optional tape	W. optional tape	No	W. optional tape
Profile off PCB	Through hole : 3,65mm SMT: 3,85mm	6,5mm	5,85mm	10,3mm	9,9mm	Through hole: 4mm SMT: 2,85mm	4,40mm	1,6mm
Mounting options								
Horizontal SMT	X					X	X	X
Vertical Through hole	X	X	X	X	X	X	X	
Horizontal Through hole		X						

F



www.ermec.com

CR36 series outside the US and the UK.

P36 series

Low profile rotary code switches

Surface mount or through-hole



- 3 actuator types
- Save board space
- Highly reliable
- Solder and flux sealed, washable

P36				
SERIES	Mounting	Actuators	Codes	Terminals
	(none) Through-hole S Surface mount	1 Screwdriver 3 Spindle 8 Slotted spindle	01 BCD 02 BCD complement 03 Hexadecimal 06 Hexadec. complement	(none) Straight or SMT V Crimped L254 Right angle, spacing 2,54 (.100)

ELECTRICAL SPECIFICATIONS

- Operating voltage : 24 VDC max.
- Contact load, static : 400mA max.
- Contact load, dynamic : 100mA max.
- Initial contact resistance : 100 mΩ max.
- Insulation resistance : 100 MΩ min.

MECHANICAL AND THERMAL SPECS

- Torque : 0,7 Ncm min.
- Expected life : 10.000 cycles min.
- Operating temperature : -30°C to +90°C

MATERIALS

- Base : UL94-V0, high temperature thermoplastic
- Cover : stainless steel
- Actuator : PA 4.6 nylon
- Contacts : gold over nickel plated phosphor bronze
- Terminals : tin plated

SOLDER RECOMMENDATIONS

(DIN CEI 68-2-20)

- Manual soldering : 340°C max. for 2 seconds max.
- Wave soldering : 280°C max. for 5 seconds max.
- Reflow soldering : 260°C max. for 10 seconds max.

PACKAGING

P36S1..
1300 pieces per reel
(dim.A = 22,4 mm
dim B = 16,4 mm)

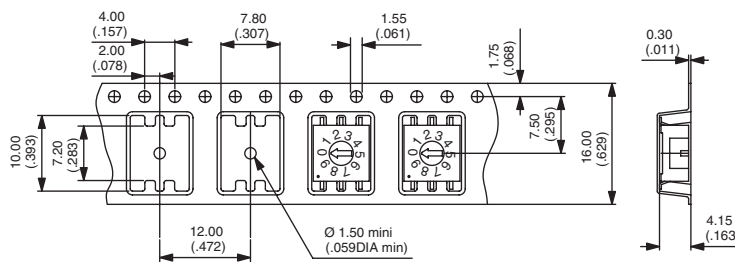

P36S3..
P36S8..
600 pieces per reel
(dim.A = 30,4 mm
dim B = 24,4 mm)

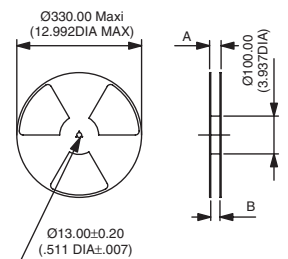
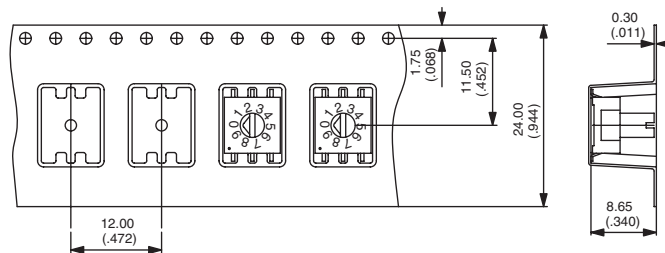

- Reels : see above. To order a SMT product with tape & reel packaging, add "TR" at the end of its part number.
- Tubes : 50 pieces (through-hole or SMT) per tube.

Dimensions : first dimensions are in mm while inches are shown as bracketted numbers.



www.ermec.com

P36 series

ermec@ermec.com

Low profile rotary code switches

Surface mount or through-hole

MOUNTING

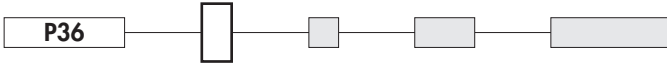

(none) Through-hole

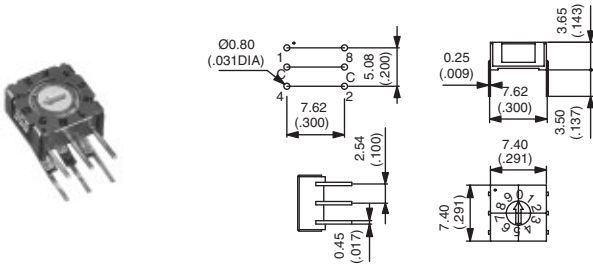

S Surface mount

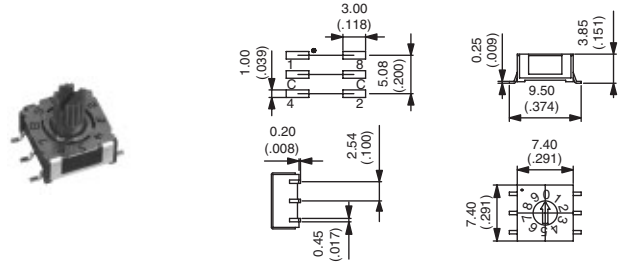

ACTUATORS

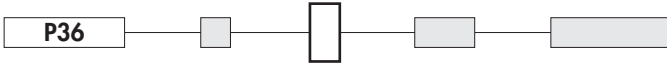

1 Screwdriver

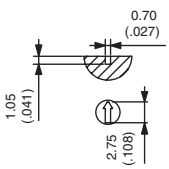

3 Spindle

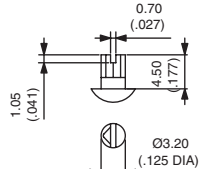

8 Slotted spindle

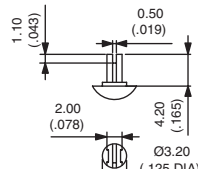

Actuator colour depending on codes

BCD red
 BCD compl. orange
 Hexadecimal grey
 Hexadec. compl. white

CODES / TRUTH TABLES

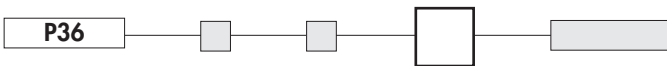

01 BCD

	C	1	2	4	8	
0	●					0
1	●	●				1
2	●		●			2
3	●	●	●			3
4	●			●		4
5	●	●		●		5
6	●		●	●		6
7	●	●	●	●		7
8	●				●	8
9	●	●			●	9

▲ Position ▲ Marking

02 BCD complement

	C	1	2	4	8	
0	●	●	●	●	●	0
1	●	●	●	●	●	1
2	●	●	●	●	●	2
3	●		●	●	●	3
4	●	●	●	●	●	4
5	●		●	●	●	5
6	●	●		●	●	6
7	●		●	●	●	7
8	●	●	●	●	●	8
9	●		●	●	●	9

03 Hexadecimal

	C	1	2	4	8	
0	●					0
1	●	●				1
2	●		●			2
3	●	●	●			3
4	●			●		4
5	●	●		●		5
6	●		●	●		6
7	●	●	●	●		7
8	●				●	8
9	●	●			●	9
10	●		●		●	A
11	●	●	●		●	B
12	●			●	●	C
13	●			●	●	D
14	●		●	●	●	E
15	●	●	●	●	●	F

06 Hexadecimal complement

	C	1	2	4	8	
0	●	●	●	●	●	0
1	●	●	●	●	●	1
2	●	●	●	●	●	2
3	●			●	●	3
4	●	●	●		●	4
5	●				●	5
6	●	●			●	6
7	●				●	7
8	●	●	●	●		8
9	●		●	●		9
10	●	●		●		A
11	●			●		B
12	●	●	●			C
13	●		●			D
14	●	●				E
15	●					F

TERMINALS

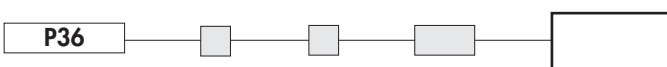

(none) Straight or SMT



V Crimped

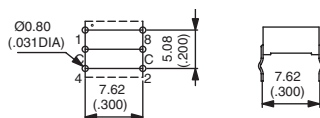

L254 Right angle, spacing 2,54 (.100)

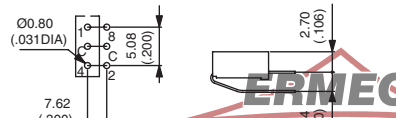

www.ermec.com

CR65 series, with a blue case, outside the US and the UK.

PT65 series

Rotary code switches

Through-hole



- 4 actuator types
- Save board space
- Highly reliable
- Solder and flux sealed, washable

PT65			
SERIES	Actuators	Codes	Terminals
	<ul style="list-style-type: none"> 1 Screwdriver 3 Spindle 5 Segment wheel 7 Accessories 	<ul style="list-style-type: none"> 01 BCD 02 BCD complement 03 Hexadecimal 06 Hexadecimal complement 	<ul style="list-style-type: none"> (none) Straight L254 Right angle, spacing 2,54 (.100) L508 Right angle, spacing 5,08 (.200)

ELECTRICAL SPECIFICATIONS
<ul style="list-style-type: none"> • Operating voltage : 24 VDC max. • Contact load, static : 400mA max. • Contact load, dynamic : 150mA max. • Initial contact resistance : 80 mΩ max. • Insulation resistance : 100 MΩ min.

MECHANICAL AND THERMAL SPECS
<ul style="list-style-type: none"> • Torque : 0,7 Ncm min. • Expected life : 10.000 cycles min. • Operating temperature : -20°C to +70°C

MATERIALS
<ul style="list-style-type: none"> • Base : UL94-V0, high temperature thermoplastic • Cover : UL94-V0, high temperature thermoplastic, grey • Actuator : PA 4.6 nylon • Contacts : gold over nickel plated phosphor bronze • Terminals : tin plated

SOLDER RECOMMENDATIONS
(DIN CEI 68-2-20)
<ul style="list-style-type: none"> • Manual soldering : 340°C max. for 2 seconds max. • Wave soldering : 260°C max. for 10 seconds max.

PACKAGING
<ul style="list-style-type: none"> • Switches for screwdriver slot or accessory actuation (PT651 and PT657) : tubes of 50 pieces • Switches with spindle (PT653) or segment wheel (PT655) : candy trays of 50 pieces • Accessories : bags of 50 pieces

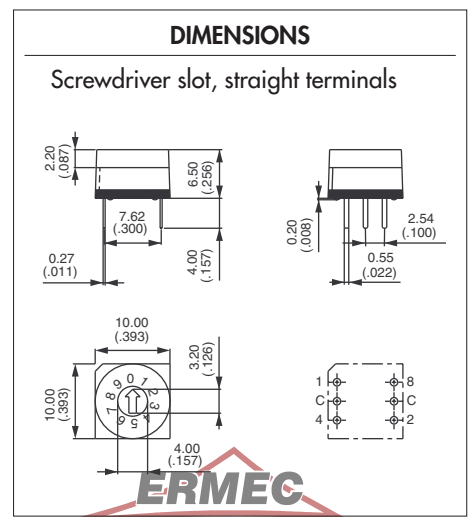

Dimensions : first dimensions are in mm while inches are shown as bracketted numbers.



www.ermec.com

PT65 series

ermec@ermec.com

Rotary code switches

Through-hole

ACTUATORS

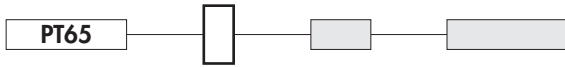

1 Screwdriver

3 Spindle (grey)

5 Segment wheel (grey)

7 Accessories

See next page

CODES / TRUTH TABLES



01 BCD

	C	1	2	4	8	
0	●					0
1	●	●				1
2	●		●			2
3	●	●	●			3
4	●			●		4
5	●	●		●		5
6	●		●	●		6
7	●	●	●	●		7
8	●				●	8
9	●	●			●	9

02 BCD complement

	C	1	2	4	8	
0	●	●	●	●	●	0
1	●	●	●	●	●	1
2	●	●	●	●	●	2
3	●	●	●	●	●	3
4	●	●	●	●	●	4
5	●	●	●	●	●	5
6	●	●	●	●	●	6
7	●	●	●	●	●	7
8	●	●	●	●	●	8
9	●	●	●	●	●	9

03 Hexadecimal

	C	1	2	4	8	
0	●					0
1	●	●				1
2	●		●			2
3	●	●	●			3
4	●			●		4
5	●	●		●		5
6	●		●	●		6
7	●	●	●	●		7
8	●				●	8
9	●	●			●	9
10	●		●		●	A
11	●	●			●	B
12	●		●	●		C
13	●	●		●	●	D
14	●		●	●	●	E
15	●	●	●	●	●	F

06 Hexadecimal complement

	C	1	2	4	8	
0	●	●	●	●	●	0
1	●	●	●	●	●	1
2	●	●	●	●	●	2
3	●	●	●	●	●	3
4	●	●	●	●	●	4
5	●	●	●	●	●	5
6	●	●	●	●	●	6
7	●	●	●	●	●	7
8	●	●	●	●	●	8
9	●	●	●	●	●	9
10	●	●	●	●	●	A
11	●	●	●	●	●	B
12	●	●	●	●	●	C
13	●	●	●	●	●	D
14	●	●	●	●	●	E
15	●	●	●	●	●	F

▲ Position ▲ Marking

TERMINALS



(none) Straight

L254 Right angle spacing 2,54 (.100)

L508 Right angle spacing 5,08 (.200)



www.ermec.com

PT65 series

Rotary code switches

Through-hole

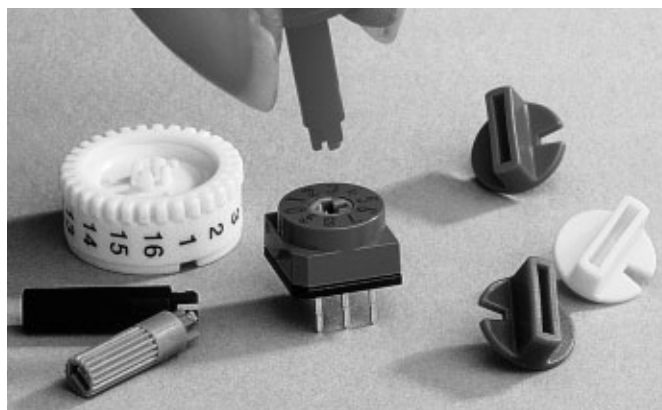

ACCESSORIES ADAPTED TO YOUR APPLICATIONS

Basic model PT657 has been designed to accept different actuators with snap-in connection.

According to your application, you can choose between spindles or plastic knobs in two different lengths and a Ø 17 mm (.669) knurled wheel for lateral marking.

Standard colours are shown below. Special colours are also available on request.

<p>SPINDLES Length 11,6 mm (standard) Length 13,3 mm</p>	<p>P/N U4822 U4824 U4832</p>	<p>COLOURS black grey black</p>	
<p>PLASTIC KNOBS Length 5,3 mm (standard) Length 15,7 mm Length 4,4 mm</p>	<p>P/N U4906 U4916 U4941 U4943 U4944 U4945 U4946</p>	<p>COLOURS red red blue green grey yellow red</p>	
<p>KNURLED WHEEL (unmarked - marking on request)</p>	<p>P/N U4847/1</p>	<p>COLOUR white/black</p>	<p>→ Panel</p>

STANDARD PRODUCTS

MODELS CODES	FOR SCREWDRIVER		WITH SPINDLE	WITH SEGMENT WHEEL		FOR ACCESS.
	Upper actuation	Side actuation	Upper actuation	Upper actuation	Side actuation	Upper actuation
BCD	PT65101	PT65101L254	PT65301	PT65501	-	PT65701
		PT65101L508			-	
BCD complement	PT65102	-	-	PT65502	-	-
Hexadecimal	PT65103	PT65103L254	PT65303	PT65503	PT65303L254	-
		PT65103L508				-
Hexadecimal complem.	PT65106	-	-	-	-	-



www.ermec.com

DIP switches

Distinctive features and specifications

- Standard, piano and right angle models
- 2 to 12 positions
- Top tape sealing option

ELECTRICAL SPECIFICATIONS

- Current/voltage rating :
 - non-switching : 100mA 50VDC
 - switching : 50mA 24VDC
- Contact resistance (at 100mA) :
 - 50mΩ max. at initial
 - 100mΩ after life test
- Insulation resistance (at 100VDC +/-15V) :
 - 100 MΩ min. between adjacent terminals
- Dielectric strength : 500VDC for one minute
- Capacitance : 5 pF between adjacent terminals
- Circuit : single pole, single throw
- Electrical life : 2.000 cycles min. per switch

MATERIALS

- Case, UL94-V0, glass fiber filled PBT, black
- Cover : UL94-V0, glass fiber filled PBT, red
- Actuator : UL94-V0, glass fiber filled PBT, white
- Terminals/contacts : gold over nickel plated phosphor bronze
- Terminal seal : epoxy
- Tape seal : polyester film

GENERAL SPECIFICATIONS

- Operating force :
 - DP models : 4N
 - DS/DA models : 8N
- Travel : 2 mm (.078)
- Mechanical life : 5.000 cycles min. per switch
- Vibration test : MIL-STD-202F method 201A
- Shock test : MIL-STD-202F method 213B, condition A
- Operating temperature : -20°C to +70°C

RECOMMENDED SOLDERING AND CLEANING PROCESSES

- Hand soldering : 320°C max. for 2 seconds max. (30 watt iron max.)
- Wave soldering : 260°C max. for 5 seconds max.
- Force rinse, high agitation or triple bath cleaning method (**with tape seal, option T**) : freon TF or TE. When vapor methods are used, do not subject switch to solvents above 51°C.

Note : keep switches in "OFF" position during soldering and cleaning for best results.

Dimensions : first dimensions are in mm while inches are shown as bracketted numbers.



Packaging unit : standard IC tubes - Quantities depending on model. See table below.

DS/DSR	Quantity	DS-T/DSR-T	Quantity	DA	Quantity	DA-T	Quantity	DP/DPL	Quantity	DP-T/DPL-T	Quantity
DS(R)-02	72	DS(R)-02T	70	DA-02	73	DA-02T	70	DP(L)-02	70	DP(L)-02T	65
DS(R)-03	51	DS(R)-03T	50	DA-03	52	DA-03T	50	DP(L)-03	50	DP(L)-03T	48
DS(R)-04	40	DS(R)-04T	39	DA-04	40	DA-04T	39	DP(L)-04	39	DP(L)-04T	39
DS(R)-05	32	DS(R)-05T	32	DA-05	33	DA-05T	32	DP(L)-05	32	DP(L)-05T	32
DS(R)-06	27	DS(R)-06T	28	DA-06	28	DA-06T	28	DP(L)-06	27	DP(L)-06T	25
DS(R)-07	24	DS(R)-07T	24	DA-07	24	DA-07T	24	DP(L)-08	21	DP(L)-08T	21
DS(R)-08	21	DS(R)-08T	21	DA-08	21	DA-08T	21	DP(L)-10	17	DP(L)-10T	17
DS(R)-09	19	DS(R)-09T	19	DA-09	19	DA-09T	19	DP(L)-12	14	DP(L)-12T	14
DS(R)-10	17	DS(R)-10T	17	DA-10	17	DA-10T	17				
DS(R)-12	14	DS(R)-12T	14	DA-12	14	DA-12T	14				

ERMEC
www.ermec.com

www.ermec.com

DS/DSR series

Standard DIP switches

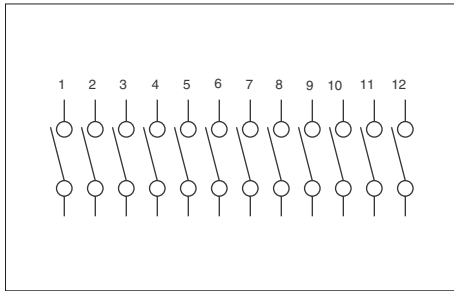

- Raised or recessed actuator
- 2 to 12 positions

MODEL
STRUCTURE



Raised actuator : DS



Model No	No. pos.	Dim "A"	Dim. "B"
DS-02	2	6,60 (.259)	2,54 (.100)
DS-03	3	9,14 (.359)	5,08 (.200)
DS-04	4	11,68 (.459)	7,62 (.300)
DS-05	5	14,22 (.559)	10,16 (.400)
DS-06	6	16,76 (.659)	12,70 (.500)
DS-07	7	19,30 (.759)	15,24 (.600)
DS-08	8	21,84 (.859)	17,78 (.700)
DS-09	9	24,38 (.959)	20,32 (.800)
DS-10	10	26,92 (1.059)	22,86 (.900)
DS-12	12	32,00 (1.259)	27,94 (1.100)

Top tape sealed : add "T" after model number.

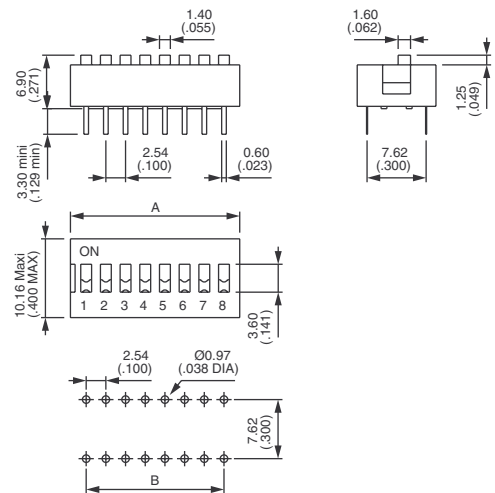

Recessed actuator : DSR



Model No	No. pos.	Dim "A"	Dim. "B"
DSR-02	2	6,60 (.259)	2,54 (.100)
DSR-03	3	9,14 (.359)	5,08 (.200)
DSR-04	4	11,68 (.459)	7,62 (.300)
DSR-05	5	14,22 (.559)	10,16 (.400)
DSR-06	6	16,76 (.659)	12,70 (.500)
DSR-07	7	19,30 (.759)	15,24 (.600)
DSR-08	8	21,84 (.859)	17,78 (.700)
DSR-09	9	24,38 (.959)	20,32 (.800)
DSR-10	10	26,92 (1.059)	22,86 (.900)
DSR-12	12	32,00 (1.259)	27,94 (1.100)

Top tape sealed : add "T" after model number.

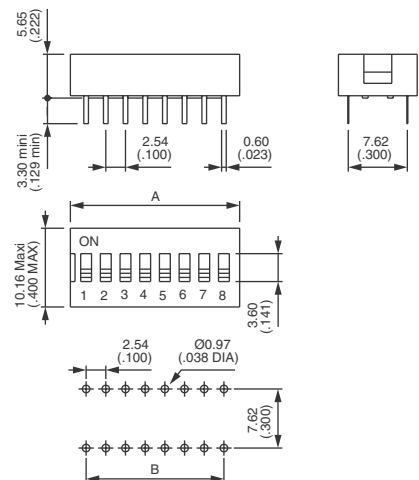

DP/DPL series

ermec@ermec.com

Piano DIP switches

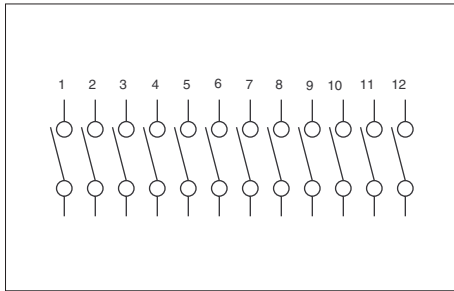

- Short or long actuator
- 2 to 12 positions

Note : Push down for "ON" is our standard type.
Push down for "OFF" is also available on special order, consult factory.

MODEL
STRUCTURE

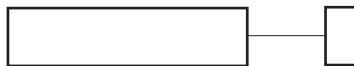

Short actuator : DP

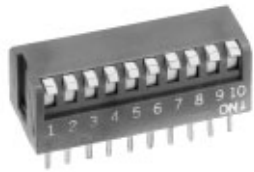

Model No	No. pos.	Dim "A"	Dim. "B"
DP-02	2	6,63 (.261)	2,54 (.100)
DP-03	3	9,17 (.361)	5,08 (.200)
DP-04	4	11,71 (.461)	7,62 (.300)
DP-05	5	14,25 (.561)	10,16 (.400)
DP-06	6	16,8 (.661)	12,70 (.500)
DP-08	8	21,87 (.861)	17,78 (.700)
DP-10	10	26,95 (1.061)	22,86 (.900)
DP-12	12	32,03 (1.261)	27,94 (1.100)

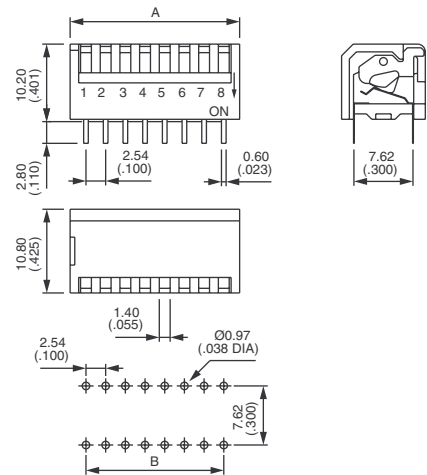

Top tape sealed : add "T" after model number.

Long actuator : DPL



Model No	No. pos.	Dim "A"	Dim. "B"
DPL-02	2	6,63 (.261)	2,54 (.100)
DPL-03	3	9,17 (.361)	5,08 (.200)
DPL-04	4	11,71 (.461)	7,62 (.300)
DPL-05	5	14,25 (.561)	10,16 (.400)
DPL-06	6	16,8 (.661)	12,70 (.500)
DPL-08	8	21,87 (.861)	17,78 (.700)
DPL-10	10	26,95 (1.061)	22,86 (.900)
DPL-12	12	32,03 (1.261)	27,94 (1.100)

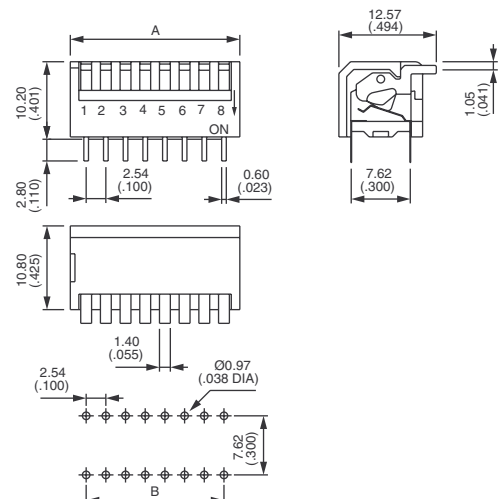

Top tape sealed : add "T" after model number.

www.ermec.com

DA series

Right angle DIP switches

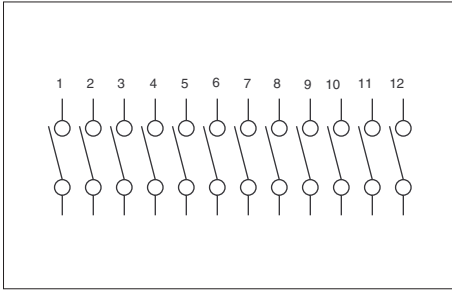

- 2 to 12 positions

MODEL
STRUCTURE



Raised actuator : DA



Model No	No. pos.	Dim "A"	Dim. "B"
DA-02	2	6,60 (.259)	2,54 (.100)
DA-03	3	9,14 (.359)	5,08 (.200)
DA-04	4	11,68 (.459)	7,62 (.300)
DA-05	5	14,22 (.559)	10,16 (.400)
DA-06	6	16,76 (.659)	12,70 (.500)
DA-07	7	19,30 (.759)	15,24 (.600)
DA-08	8	21,84 (.859)	17,78 (.700)
DA-09	9	24,38 (.959)	20,32 (.800)
DA-10	10	26,92 (1.059)	22,86 (.900)
DA-12	12	32,00 (1.259)	27,94 (1.100)

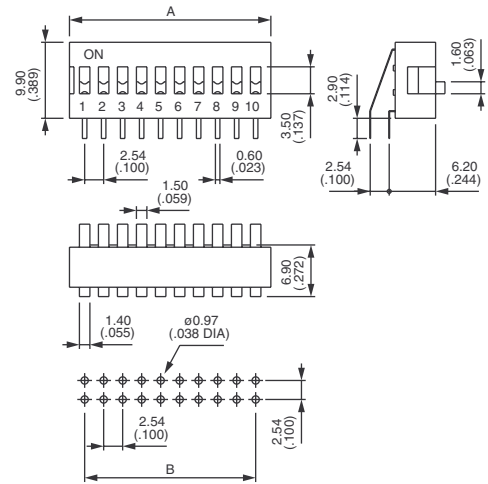

Top tape sealed : add "T" after model number.

F



www.ermec.com

Distinctive features

Low profile

- The lowest case available in 2, 4, 6 and 8 pole versions
- Reduction of the shadow effect in IR soldering
- 30 % reduction of component volume

Two versions

Surface mount models

- Designed for reflow soldering
- UL 94-V0 high temperature materials
- Tin plated terminals

Through-hole models

- Same thermal specifications as SMT models, allowing mixed soldering process



Washable by construction

- Moulded-in terminals
- Ultrasonic-welded case
- Two slots on case corners allowing removal of protection tape

Reliable contacts

- Anti-crush system on moving contact
- Bifurcated self-cleaning sliding contacts
- Positive detent actuation
- Recessed slide actuators preventing accidental actuation
- Good visibility of actuators : black slide on clear background

Two types of packaging

Surface mount models

- Tape and reel (1.000 pieces per reel) - IC tubes

Through-hole models

- IC tubes

Dimensions : first dimensions are in mm while inches are shown as bracketted numbers.



www.ermec.com

IKN series

Surface mount DIP switches

Low profile

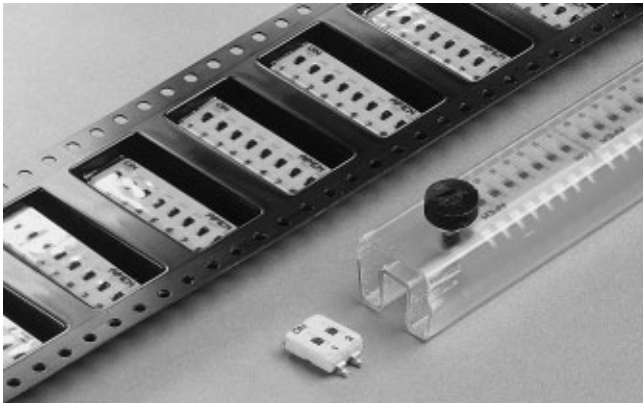

- Overall height from PCB : 2,85 mm (.112)
- Self-cleaning wiping contacts
- Recessed actuator with positive detent
- Tin plated terminals
- Process compatible - withstand IR reflow soldering (see Technical Information, Surface Mount, end of catalogue)
- Washable

Tape & reel	IC tubes	No pos.	Dimension "A"
IKN0204000	IKN0203000	2	6 (.236)
IKN0404000	IKN0403000	4	11,10 (.437)
IKN0604000	IKN0603000	6	16,20 (.637)
IKN0804000	IKN0803000	8	21,30 (.838)

Supplied with all poles in "ON" position.
Other models (3, 5 and 7 positions) : on request

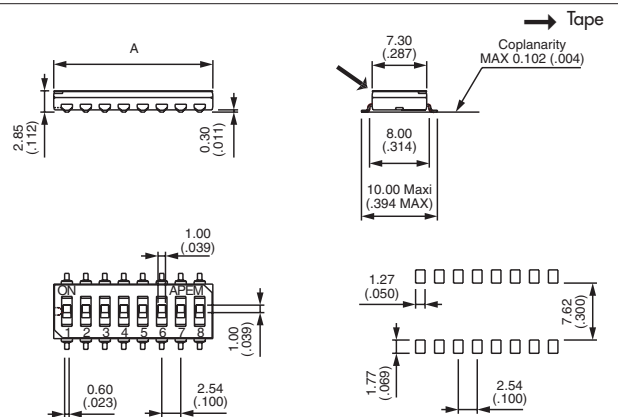

PACKAGING

Unrolling direction →

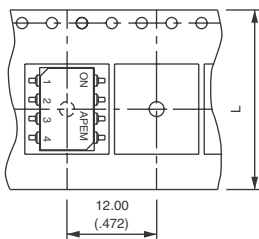

Pos.	Tape dim. "L"	Reel dim. "A"
2	16 (.629)	16,40 (.646)
4	24 (.944)	24,40 (.960)
6	24 (.944)	24,40 (.960)
8	32 (1.259)	32,40 (1.275)

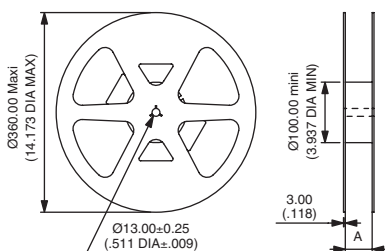

SPECIFICATIONS

- Max. current/voltage rating :
 - switching : 100mA 24VDC
 - non-switching : 100mA 48VDC
- Contact resistance :
 - initial : 30 mΩ max.
 - after 2.000 cycles : 100 mΩ max.
- Insulation resistance : 1.000 MΩ min. at 500VDC
- Dielectric strength : 500 VAC min.
- Electrical life : 2.000 cycles
- Travel : 0,67 mm (.026)
- Operating temperature : -40°C to +100°C
- Storage temperature : -40°C to +125°C

MATERIALS

- Case and actuator : UL 94-V0 thermoplastic
- Stationary contact : bronze, gold plated over nickel barrier
- Moving contact : beryllium copper, gold plated
- Terminals : tin plated over nickel barrier
- Protection tape : polyimide

Antistatic packaging - Standard packaging units :

- Reels of 1.000 pieces
- Tape meeting international standard IEC - Publication 286-3 (EIA481A)
- Start leader : 400 mm min. - End leader : 160 mm
- IC tubes : see next page.



www.ermec.com

IKN series

ermec@ermec.com

Through-hole DIP switches

Low profile

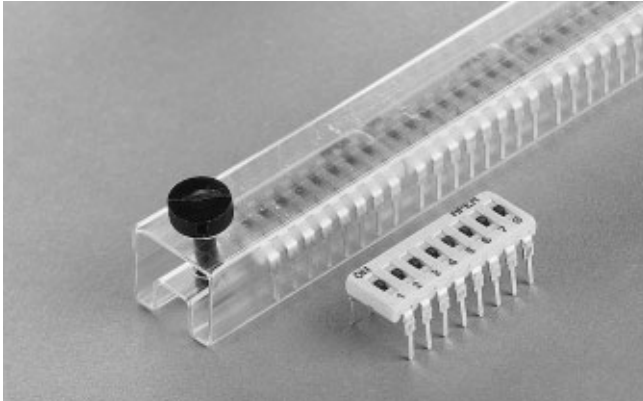

- Overall height from PCB : 4 mm (.156)
- Self-cleaning wiping contacts
- Recessed actuator with positive detent
- Tin plated terminals
- Wave solderable
- Washable

Model No	No pos.	Dimension "A"
IKN0200000	2	6 (.236)
IKN0400000	4	11,10 (.437)
IKN0600000	6	16,20 (.637)
IKN0800000	8	21,30 (.838)

Supplied with all poles in "ON" position.
Other models (3, 5 and 7 positions) : on request

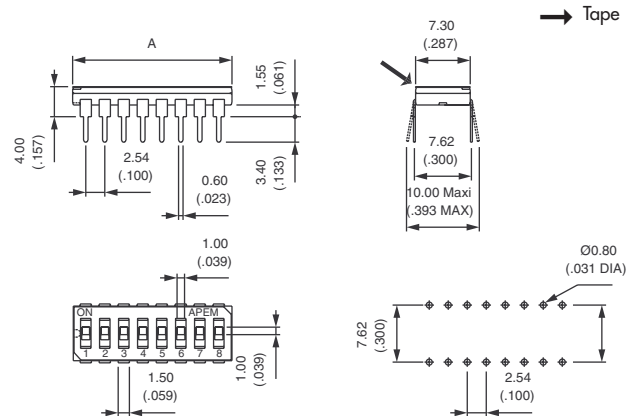

PACKAGING

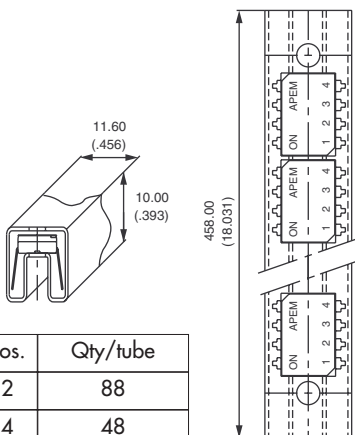

Pos.	Qty/tube
2	88
4	48
6	33
8	25

IC TUBES

SPECIFICATIONS

- Max. current/voltage rating :
 - switching : 100mA 24VDC
 - non-switching : 100mA 48VDC
- Contact resistance :
 - initial: 30 mΩ max.
 - after 2.000 cycles : 100 mΩ max.
- Insulation resistance : 1.000 MΩ min. at 500VDC
- Dielectric strength : 500 VAC min.
- Electrical life : 2.000 cycles
- Travel : 0,67 mm (.026)
- Operating temperature : -40°C to +100°C
- Storage temperature : -55°C to +125°C

MATERIALS

- Case and actuator : UL 94-V0 thermoplastic
- Stationary contact : bronze, gold plated over nickel barrier
- Moving contact : beryllium copper, gold plated
- Terminals : tin plated over nickel barrier
- Protection tape : polyimide



www.ermec.com

IKD series

Surface mount DIP switches

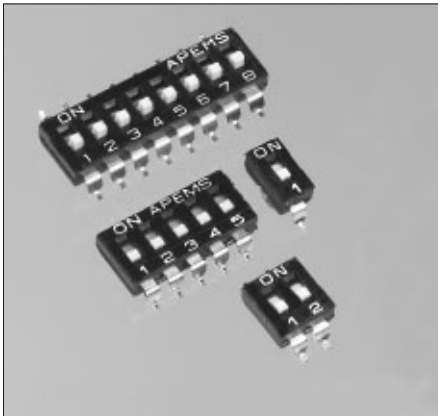

- Overall height from PCB : 4,40 mm
- Raised actuator
- Even and odd pole numbers
- Self-cleaning wiping contacts
- Gold plated terminals
- Process compatible - withstand IR reflow soldering
(see Technical Information, Surface Mount, end of catalogue)

Models with recessed actuator and tape available on request.

Tape & reel	IC tubes	No pos.	Dimension "A"	Qty/tube
IKD0104101	IKD0103101	1	3,48 (.137)	130
IKD0204101	IKD0203101	2	6,02 (.237)	76
IKD0304101	IKD0303101	3	8,56 (.337)	55
IKD0404101	IKD0403101	4	11,10 (.437)	42
IKD0504101	IKD0503101	5	13,64 (.537)	35
IKD0604101	IKD0603101	6	16,18 (.637)	28
IKD0704101	IKD0703101	7	18,72 (.737)	25
IKD0804101	IKD0803101	8	21,26 (.837)	22
IKD0904101	IKD0903101	9	23,80 (.937)	20
IKD1004101	IKD1003101	10	26,34 (1.037)	18
IKD1204101	IKD1203101	12	31,42 (1.237)	15

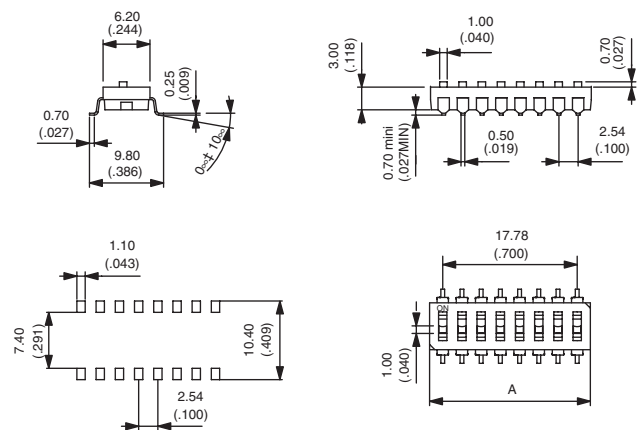

Supplied with all poles in "OFF" position.

SPECIFICATIONS

- Max. current/voltage rating :
 - switching : 25mA 24VDC
 - non-switching : 100mA 50VDC
- Initial contact resistance : 50 mΩ max.
- Insulation resistance : 100 MΩ min. at 500VDC
- Dielectric strength : 500 VAC min.
- Electrical life : 2.000 cycles
- Travel : 1 mm (.039)
- Operating temperature : -20°C to +85°C
- Storage temperature : -40°C to +85°C

MATERIALS

- Case and actuator : UL94-V0 thermoplastic
- Moving contact : phosphor bronze, gold plated, over nickel barrier
- Terminals : gold plated

Antistatic packaging - standard packaging units

- Reels of 900 pieces
Tape meeting international standard IEC, publication 286-3 (EIA481A).
- IC tubes : see above chart for quantities.

Dimensions : first dimensions are in mm while inches are shown as bracketted numbers.



www.ermec.com

IKD series

ermec@ermec.com

Through-hole DIP switches

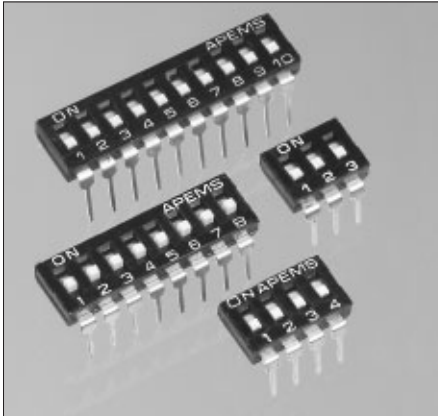

- Overall height from PCB : 4,40 mm
- Raised actuator
- Even and odd pole numbers
- Self-cleaning wiping contacts
- Gold plated terminals
- Wave solderable

Models with recessed actuator and tape available on request.

Model No	No pos.	Dimension "A"	Qty/tube
IKD0100101	1	3,48 (.137)	130
IKD0200101	2	6,02 (.237)	76
IKD0300101	3	8,56 (.337)	55
IKD0400101	4	11,10 (.437)	42
IKD0500101	5	13,64 (.537)	34
IKD0600101	6	16,18 (.637)	29
IKD0700101	7	18,72 (.737)	25
IKD0800101	8	21,26 (.837)	22
IKD0900101	9	23,80 (.937)	20
IKD1000101	10	26,34 (1.037)	18
IKD1200101	12	31,42 (1.237)	15

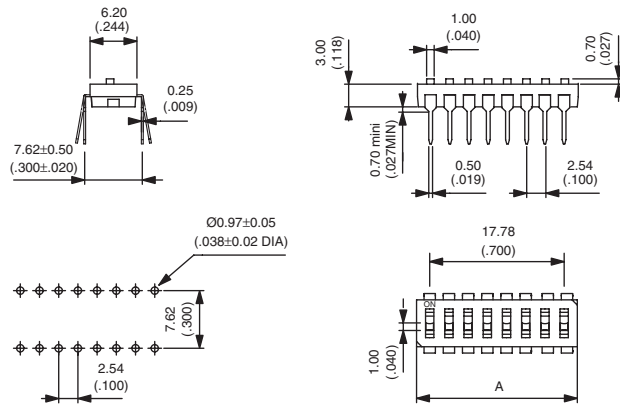

Supplied with all poles in "OFF" position.

SPECIFICATIONS

- Max. current/voltage rating :
 - switching : 25mA 24VDC
 - non-switching : 100mA 50VDC
- Initial contact resistance : 50 mΩ max.
- Insulation resistance : 100 MΩ min. at 500VDC
- Dielectric strength : 500 VAC min.
- Electrical life : 2.000 cycles
- Travel : 1 mm (.039)
- Operating temperature : -20°C to +85°C
- Storage temperature : -40°C to +85°C

Antistatic packaging - standard packaging units

- IC tubes : see above chart for quantities.

MATERIALS

- Case and actuator : UL94-V0 thermoplastic
- Moving contact : phosphor bronze, gold plated, over nickel barrier
- Terminals : gold plated

Dimensions : first dimensions are in mm while inches are shown as bracketted numbers.



www.ermec.com

IKH series

Surface mount half pitch DIP switches

Very low profile

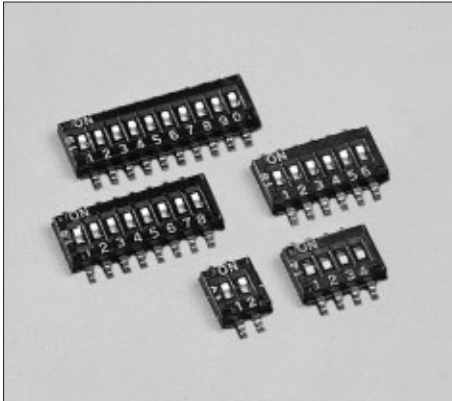

- 1,27 mm (.050) terminal to terminal pitch
- Overall height from PCB : 1,6 mm (.063) only
- Very small PCB space requirement
- Process compatible - withstand IR reflow soldering
(see Technical Information, Surface Mount, end of catalogue)
- Washable (tape seal standard)

Tape & reel	IC tubes (Qty)	No pos.	Dimension "A"
IKH0204000	IKH0203000 (125)	2	3,77 (.148)
IKH0404000	IKH0403000 (75)	4	6,31 (.248)
IKH0604000	IKH0603000 (54)	6	8,85 (.348)
IKH0804000	IKH0803000 (40)	8	11,39 (.448)
IKH1004000	IKH1003000 (33)	10	13,93 (.548)

Supplied with all poles in "ON" position.
Switches without tape seal : on request.

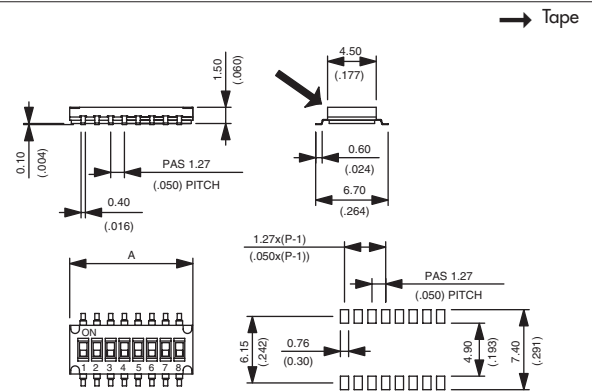

TAPE AND REEL PACKAGING

Unrolling direction →

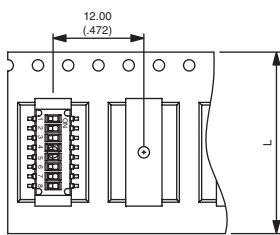

Pos.	Tape dim. "L"	Reel dim. "A"
2	12,00 (.472)	12,40 (.488)
4	16,00 (.629)	16,40 (.646)
6	16,00 (.629)	16,40 (.646)
8	24,00 (.944)	24,40 (.960)
10	24,00 (.944)	24,40 (.960)

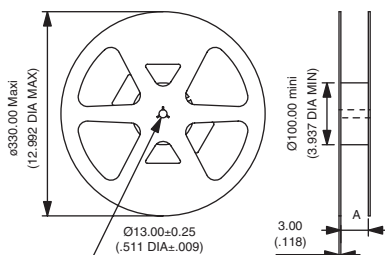

SPECIFICATIONS

- Max. current/voltage rating :
 - switching : 25mA 24VDC
 - non switching : 100mA 50VDC
- Initial contact resistance : 100 mΩ max.
- Insulation resistance : 100 MΩ min. at 500VDC
- Dielectric strength : 300 Vca min.
- Electrical life : 1.000 cycles
- Travel : 0,60 mm (.024)
- Operating temperature : -20°C to +70°C
- Storage temperature : -40°C to +85°C

MATERIALS

- Case and cover : high temperature thermoplastic UL 94-V0, black
- Actuator : high temperature thermoplastic UL 94-V0, white
- Contacts : phosphor bronze, gold plated, over nickel barrier
- Terminals : tin plated
- Tape seal : polyimide

Antistatic packaging - standard packaging units

- Reels of 4.000 pieces
Tape meeting international standard IEC - Publication 286-3 (EIA481A)
- IC tubes : see above.

Dimensions in mm and inches.



www.ermec.com