



## 1.27 mm SRC Single Row Connector MiniBridge™ Cable System

**ERMEC, S.L. BARCELONA**  
C/ Francesc Teixidó, 22  
E-08918 Badalona  
(Spain)



Tel.: (+34) 902 450 160  
Fax: (+34) 902 433 088  
[info@ermec.com](mailto:info@ermec.com)  
[www.ermec.com](http://www.ermec.com)

**ERMEC, S.L. MADRID**  
C/ Sagasta, 8, 1ª planta  
E-28004 Madrid  
(Spain)

**PORTUGAL**  
[portugal@ermec.com](mailto:portugal@ermec.com)  
**BILBAO**  
[bilbao@ermec.com](mailto:bilbao@ermec.com)

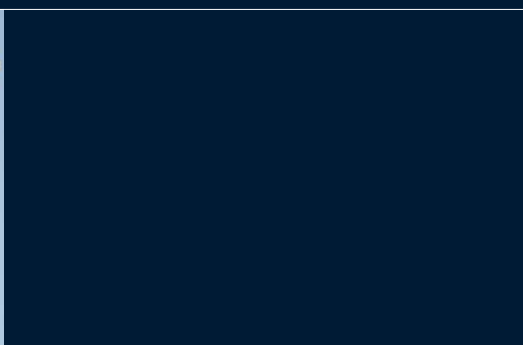
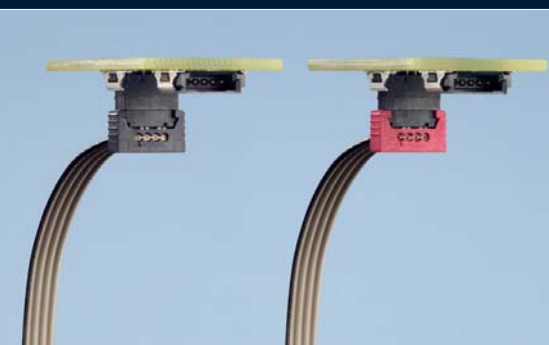

**ERMEC, S.L. BARCELONA**  
C/ Francesc Teixidó, 22  
E-08918 Badalona  
(Spain)



Tel.: (+34) 902 450 160  
Fax: (+34) 902 433 088  
[info@ermec.com](mailto:info@ermec.com)  
[www.ermec.com](http://www.ermec.com)

**ERMEC, S.L. MADRID**  
C/ Sagasta, 8, 1ª planta  
E-28004 Madrid  
(Spain)

**PORTUGAL**  
[portugal@ermec.com](mailto:portugal@ermec.com)  
**BILBAO**  
[bilbao@ermec.com](mailto:bilbao@ermec.com)

# 1.27 mm SRC Single Row Connector MiniBridge™ Cable System



## Table of Contents

General	4
Features	5
Electrical And Mechanical Characteristics	8
Right Angle Male Type A	11
Vertical Male Type P	13
Packaging	15
Cable Assemblies	16
Cable Assemblies Order Code	21
Part Number Index	22

 **ERMEC, S.L. BARCELONA**  
C/ Francesc Teixidó, 22  
E-08918 Badalona  
(Spain)

**Tel.: (+34) 902 450 160**  
**Fax: (+34) 902 433 088**  
[info@ermec.com](mailto:info@ermec.com)  
[www.ermec.com](http://www.ermec.com)

**ERMEC, S.L. MADRID**  
C/ Sagasta, 8, 1ª planta  
E-28004 Madrid  
(Spain)

**PORTUGAL**  
[portugal@ermec.com](mailto:portugal@ermec.com)  
**BILBAO**  
[bilbao@ermec.com](mailto:bilbao@ermec.com)

# 1.27 mm SRC Single Row Connector - MiniBridge™ Cable System



## General

The small size of the single-row, 1.27 mm pitch SRC connector system makes it ideal for space-saving board to cable connections. The cable connector system is used in the widest range of applications in various sectors such as automotive, industrial, consumer or medical. The versatile applications can be realized thanks to the various connection options, with right angle or vertical male connectors and female connectors with 90° or 180° cable outlet.

The male connector is available with SMT terminals, the female connector has IDC cable connections. The plastic housing of the male connector is able to withstand high temperatures, so the connector is suitable for lead-free reflow soldering processes. The male connectors are available in tape-and-reel packaging for automatic assembly.

With the female connector the cable guide ensures that attaching the cable or single strands is a simple operation.

Standard cable assemblies are available. Customized cable assemblies can be easily ordered on request.

## Features

- Pitch: 1.27 mm
- Number of pins: 2, 3, 4, 6, 8, 10 and 12
- Current carrying capacity per contact: up to 4 A\* (12 position connector up to 48 A\* per connector)
- Termination: Male Connector SMT  
Female Connector IDC
- Cable: AWG 26 ribbon cable,  
Single wire stranded or solid
- Connectors: Vertical and right angle male connectors  
Female connectors with 90° or 180° cable outlet
- Interlocking:  
Positive lock (red): unlockable only with a sharp item, e.g. tip of pen (high vibration/shock load)  
Friction lock (black): unlockable without any item (normal vibration/shock load)

\* For specific data, please see the corresponding derating curve.



ERMEC, S.L. BARCELONA  
C/ Francesc Teixidó, 22  
E-08918 Badalona  
(Spain)

Tel.: (+34) 902 450 160  
Fax: (+34) 902 433 088  
[info@ermec.com](mailto:info@ermec.com)  
[www.ermec.com](http://www.ermec.com)

ERMEC, S.L. MADRID  
C/ Sagasta, 8, 1ª planta  
E-28004 Madrid  
(Spain)

PORTUGAL  
[portugal@ermec.com](mailto:portugal@ermec.com)  
BILBAO  
[bilbao@ermec.com](mailto:bilbao@ermec.com)

# 1.27 mm SRC Single Row Connector - MiniBridge™ Cable System



## Features

### Available Terminations

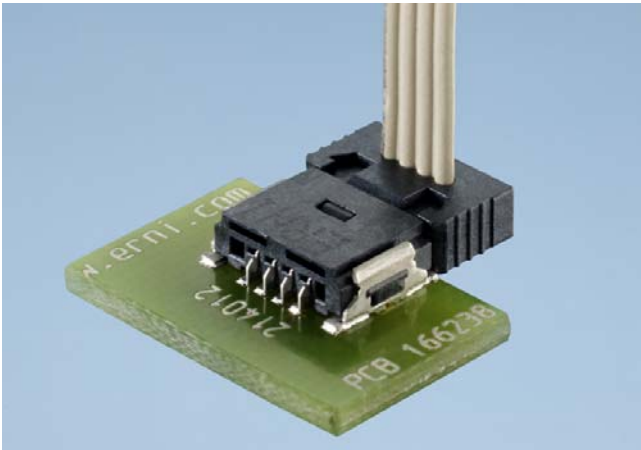

Right angle male - Female 90° cable outlet

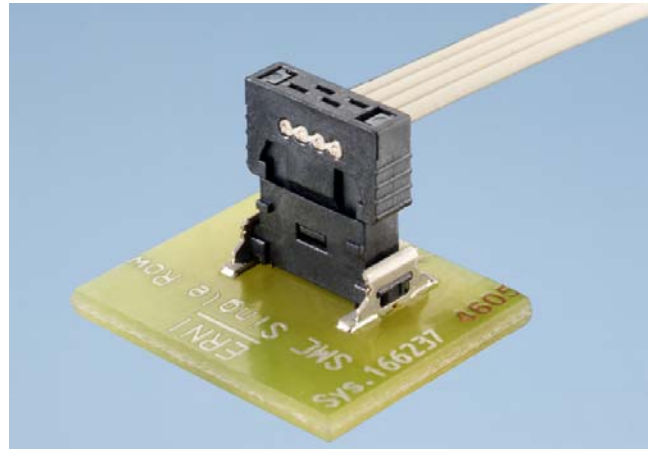

Vertical male - Female 90° cable outlet

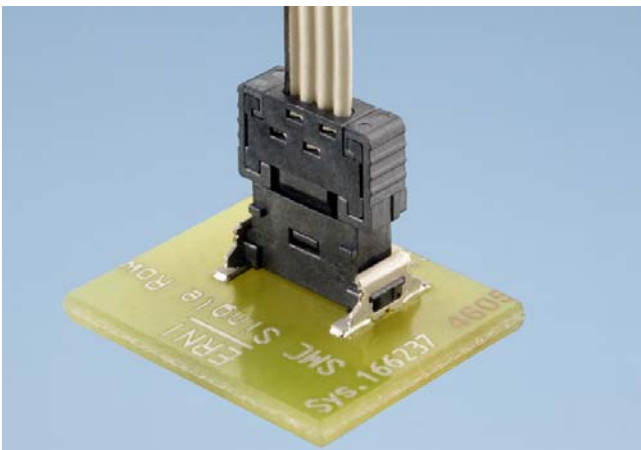

Vertical male - Female 180° cable outlet

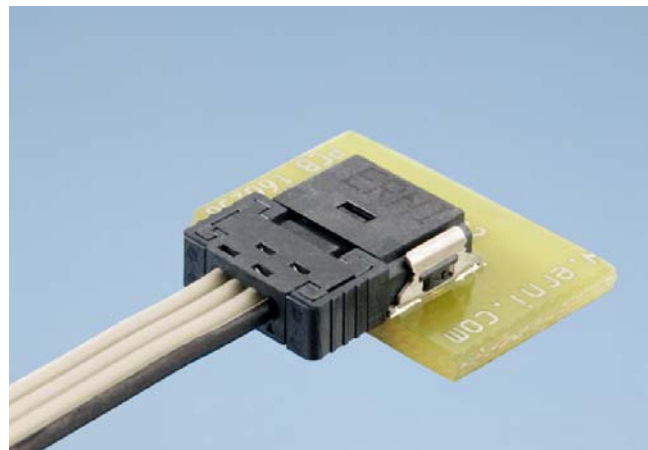

Right angle male - Female 180° cable outlet



ERMEC, S.L. BARCELONA  
C/ Francesc Teixidó, 22  
E-08918 Badalona  
(Spain)

Tel.: (+34) 902 450 160  
Fax: (+34) 902 433 088  
[info@ermec.com](mailto:info@ermec.com)  
[www.ermec.com](http://www.ermec.com)

ERMEC, S.L. MADRID  
C/ Sagasta, 8, 1ª planta  
E-28004 Madrid  
(Spain)

PORTUGAL  
[portugal@ermec.com](mailto:portugal@ermec.com)  
BILBAO  
[bilbao@ermec.com](mailto:bilbao@ermec.com)

# 1.27 mm SRC Single Row Connector - MiniBridge™ Cable System



## Features

### Processing Results



Cross Section Right Angle Male Connector



Clip



Contact



Cross Section Vertical Male Connector



Clip



Contact



Cross Section ribbon cable AWG-26  
solid wire 90° cable outlet

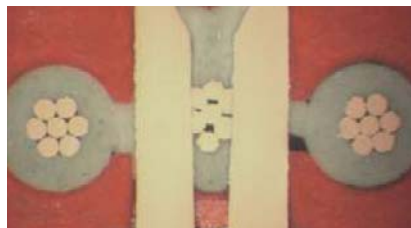

Cross section ribbon cable AWG-26  
stranded wire 180° cable outlet

### Cable Type



Ribbon Cable



Ribbon cable for higher clearance and creepage distances

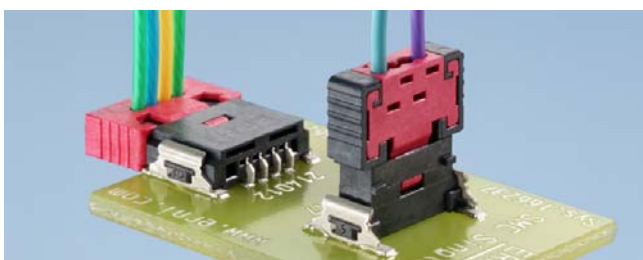

Single Wire



Round Cable



Tel.: (+34) 902 450 160  
Fax: (+34) 902 433 088  
[ermec@ermec.com](mailto:ermec@ermec.com)  
[www.ermec.com](http://www.ermec.com)

Distribución de componentes  
eléctricos y electrónicos

# 1.27 mm SRC Single Row Connector - MiniBridge™ Cable System



## Features

### Easy Assembly



Pick-and-place cover for automatic assembly with a vacuum pipette.  
Reliable retention force due to ruggedized metal clips on both sides of each male.

### Guiding Elements



The rugged insulation body of the male connector ensures an optimal cable connector guide.  
Two pegs (round and oval) for exact positioning on the pcb.

### Interlocking



Positive lock (red): unlockable only with a sharp item, e.g. tip of pen  
(high vibration/Shock load)  
Friction lock (black): unlockable without any item  
(normal vibration/shock load)



Tel.: (+34) 902 450 160  
Fax: (+34) 902 433 088  
[ermec@ermec.com](mailto:ermec@ermec.com)  
[www.ermec.com](http://www.ermec.com)



## 1.27 mm SRC

### Single Row Connector - MiniBridge™ Cable System

#### Electrical and Mechanical Characteristics



	Standard	Male Connector Type A and P	Female Connector Type A and P
Number of Pins		2, 3, 4, 6, 8, 10, 12	2, 3, 4, 6, 8, 10, 12
<b>Technical Data</b>			
Climate Category	DIN EN 60068-1 test b	55/125/56	55/125/56
Temperature range		-55/125 °C	-55/125 °C
Current rating per contact	IEC60512 test 5b	4 pin version: Ambient temperature 20 °C 4.0 A 70 °C 3.0 A 100 °C 2.0 A	Depends on cable
		The mentioned current carrying capacity values are standard values, which are reached without taking any special measures. Significant higher values are possible, if pcb design matches the connector performance. For further information please contact your ERNI sales person.	
Air- and creepage distance		contact - contact 0.4 mm	contact - contact 0.4 mm
Operating voltage	IEC 60664	The permissible operating voltages depend on the customer application and on the applicable or specified safety requirements. Insulation coordination according to IEC 60664-1 has to be regarded for the complete electrical device. Therefore, the maximum creepage and clearance distances of the mated connectors are specified for consideration as a part of the whole current path. In practice, reductions in creepage or clearance distances may occur due to the conductive pattern of the printed board or the wiring used, and have to be taken into account separately. As a result the creepage and clearance distances for the application may be reduced compared to those of the connector.	
Dielectric strength	IEC 60512	contact - contact 500 V <sub>rms</sub>	contact - contact 500 V <sub>rms</sub>
Contact resistance	IEC 60512 test 2a	< 25 mΩ	< 25 mΩ
Insulation resistance	IEC 60512 test 3a	> 10 <sup>4</sup> MΩ	> 10 <sup>4</sup> MΩ
Vibration, sine	IEC 60512 test 6d	10 – 2000 Hz 20 g	10 – 2000 Hz 20 g
Contact disturbance (while vibration test)	IEC 60512 test 2e	< 1 μs	< 1 μs
Shock halfsine	IEC 60512 test 6c	50 g 11 ms	50 g 11 ms
Contact disturbance (while shock test)	IEC 60512 test 2e	< 1 μs	< 1 μs
Mechanical operation (mating cycles)	IEC 60512 test 9a	500 mating cycles	500 mating cycles
Insertion and withdrawal force	IEC 60512 test 13b	2 cont.: 2 N    8 cont.: 8 N 3 cont.: 3 N    10 cont.: 10 N 4 cont.: 4 N    12 cont.: 12 N 6 cont.: 6 N	2 cont.: 2 N    8 cont.: 8 N 3 cont.: 3 N    10 cont.: 10 N 4 cont.: 4 N    12 cont.: 12 N 6 cont.: 6 N
Gauge retention force	IEC 60512 test 16e	> 0.1 N	> 0.1 N



# 1.27 mm SRC

## Single Row Connector - MiniBridge™ Cable System



### Electrical and Mechanical Characteristics

	Standard	Male Connector Type A and P	Female Connector Type A and P
Number of Pins		2, 3, 4, 6, 8, 10, 12	2, 3, 4, 6, 8, 10, 12
<b>Process-conditions</b>			
Solder temperature max.	IEC 68-2-20		
Hand soldering temperature max.		3.5 s at 350 °C	
Dip soldering temperature max.		10 s at 260 °C	
Reflow soldering temperature max.	JEDEC J-STD-020C	20 - 40 s at 260 °C	
Coplanarity		< 0.1 mm	
<b>Housing Materials</b>			
Plastic material (symbol)		LCP	LCP
CTI value	IEC 60112	175	175
UL flame rating		UL 94 V-0	UL 94 V-0
UL file		E83005	E83005
<b>Contact Materials</b>			
Base material		Cu alloy	Cu alloy
Mating area		gold plating	gold plating
Termination area		Sn	Sn
<b>Environment compatibility</b>			
Recycling		no flame-retardent additives, no toxic additives allow easy recycling	
<b>Product-approval</b>			
UL		E84703	E84703

 ERMEC, S.L. BARCELONA  
C/ Francesc Teixidó, 22  
E-08918 Badalona  
(Spain)

Tel.: (+34) 902 450 160  
Fax: (+34) 902 433 088  
[info@ermec.com](mailto:info@ermec.com)  
[www.ermec.com](http://www.ermec.com)

ERMEC, S.L. MADRID  
C/ Sagasta, 8, 1ª planta  
E-28004 Madrid  
(Spain)

PORTUGAL  
[portugal@ermec.com](mailto:portugal@ermec.com)  
BILBAO  
[bilbao@ermec.com](mailto:bilbao@ermec.com)

# 1.27 mm SRC Single Row Connector - MiniBridge™ Cable System



## Electrical and Mechanical Characteristics

	Standard	Standard Cable (PVC)	High Temperature Cable (TPE-ET)
Number of Pins		2, 3, 4, 6, 8, 10, 12	2, 3, 4, 6, 8, 10, 12
<b>Cable Assembly</b>			
Cross Section		AWG 26 / 7 / 0.14 mm <sup>2</sup>	AWG 26 / 7 / 0.14 mm <sup>2</sup>
Conductor		Cu wire tin-plated	Cu wire tin-plated
Marking	DIN 57207 / VDE 0207	Red	Black
Insulation		PVC	TPE-ET wall thickness min. 0.2 mm
Shore hardness		94 ±3 (Shore A)	96 ±3 (Shore A)
<b>Technical data</b>			
Temperature range		-20/105 °C (unmoved)	-60/125 °C (unmoved) -40/125 °C (moved)
Current rating		Ambient temperature 20 °C 2.8 A	Ambient temperature 20 °C 4 A
Voltage rating		max. 300 V	max. 300 V
Dielectric strength		2000 V <sub>rms</sub>	1500 V <sub>rms</sub>
Conductor resistance		≤ 135 Ω/km	≤ 138 Ω/km at 20 °C
Insulation resistance		≥ 100 MΩ x km at 20 °C	≥ 20 MΩ x km at 20 °C
Capacitance at 1 kHz		ground-signal-ground 60 pF/m	-
Inductance at 10 kHz		ground-signal-ground 0.5 μH/m	-
Impedance		ground-signal-ground 110 Ω	-
Crosstalk		Cable length 3 m: NE 5.4 / FE 6.8	-
Propagation delay		4.6 ns/m	-
UL flamability		UL 94 VW-1	-
<b>Product-approval</b>			
UL Style		2651	-
CSA Specification		AWM IA 105°C 300V, FT1	-



ERMEC, S.L. BARCELONA  
C/ Francesc Teixidó, 22  
E-08918 Badalona  
(Spain)

Tel.: (+34) 902 450 160  
Fax: (+34) 902 433 088  
[info@ermec.com](mailto:info@ermec.com)  
[www.ermec.com](http://www.ermec.com)

ERMEC, S.L. MADRID  
C/ Sagasta, 8, 1ª planta  
E-28004 Madrid  
(Spain)

PORTUGAL  
[portugal@ermec.com](mailto:portugal@ermec.com)  
BILBAO  
[bilbao@ermec.com](mailto:bilbao@ermec.com)

# 1.27 mm SRC Single Row Connector - MiniBridge™ Cable System Right Angle Male Type A



## Dimensional Drawing

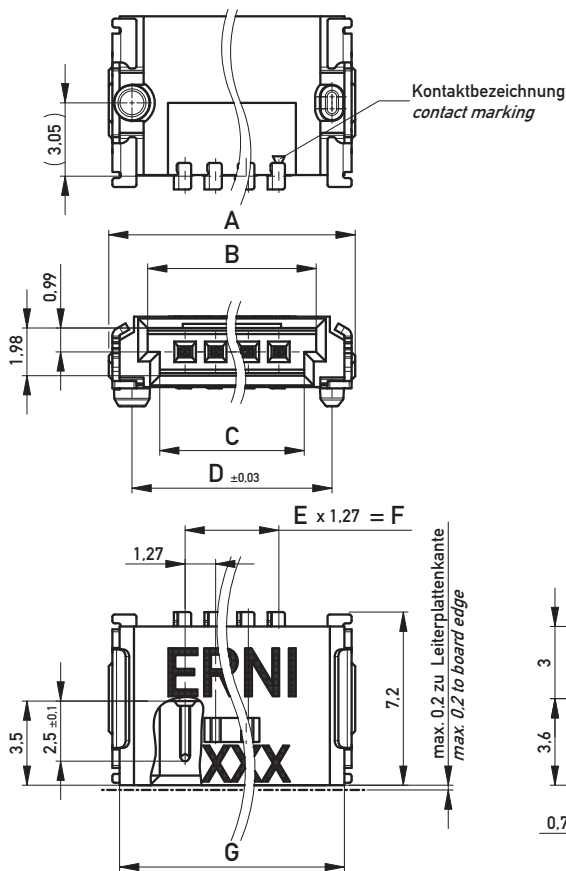

2	7.62	4.38	3.38	5.69	1	1.27	6.72
3	8.89	5.65	4.65	6.96	2	2.54	7.99
4	10.16	6.92	5.92	8.23	3	3.81	9.26
6	12.70	9.46	8.46	10.77	5	6.35	11.80
8	15.24	12.00	11.00	13.31	7	8.89	14.34
10	17.78	14.54	13.54	15.85	9	11.43	16.88
12	20.32	17.08	16.08	18.39	11	13.97	19.42
Pohlzahl No. of contacts	A	B	C	D	E	F	G

## Leiterplatten-Layout für SMT PCB-Layout for SMT

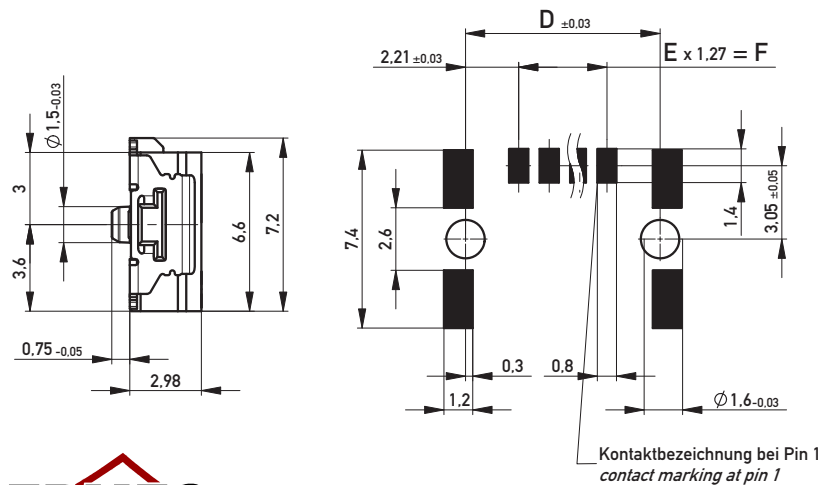

All dimensions in mm.











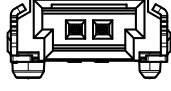
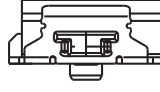

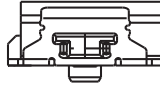
**ERMEC**  
www.ermec.com  
Distribución de componentes  
eléctricos y electrónicos

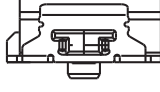
Tel.: (+34) 902 450 160  
Fax: (+34) 902 433 088  
[ermec@ermec.com](mailto:ermec@ermec.com)  
[www.ermec.com](http://www.ermec.com)

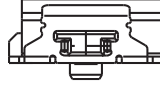
**1.27 mm SRC**  
**Single Row Connector - MiniBridge™ Cable System**  
**Right Angle Male Type A**

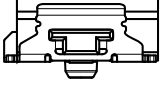

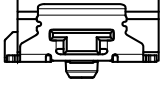
**Ordering Information**

No. of Pins	Termination	Packaging	Part Number
			
2	SMT	Tape and reel/1000 pcs	<b>214011</b>
			
3	SMT	Tape and reel/1000 pcs	<b>234450</b>
			
4	SMT	Tape and reel/1000 pcs	<b>214012</b>
			
6	SMT	Tape and reel/1000 pcs	<b>214013</b>
			
8	SMT	Tape and reel/1000 pcs	<b>214014</b>
			
10	SMT	Tape and reel/1000 pcs	<b>234464</b>
			
12	SMT	Tape and reel/1000 pcs	<b>234478</b>



**ERMEC, S.L. BARCELONA**  
 C/ Francesc Teixidó, 22  
 E-08918 Badalona  
 (Spain)

**Tel.: (+34) 902 450 160**  
**Fax: (+34) 902 433 088**  
[info@ermec.com](mailto:info@ermec.com)  
[www.ermec.com](http://www.ermec.com)

**ERMEC, S.L. MADRID**  
 C/ Sagasta, 8, 1ª planta  
 E-28004 Madrid  
 (Spain)

**PORTUGAL**  
[portugal@ermec.com](mailto:portugal@ermec.com)  
**BILBAO**  
[bilbao@ermec.com](mailto:bilbao@ermec.com)

# 1.27 mm SRC Single Row Connector - MiniBridge™ Cable System Vertical Male Type P



## Dimensional Drawing

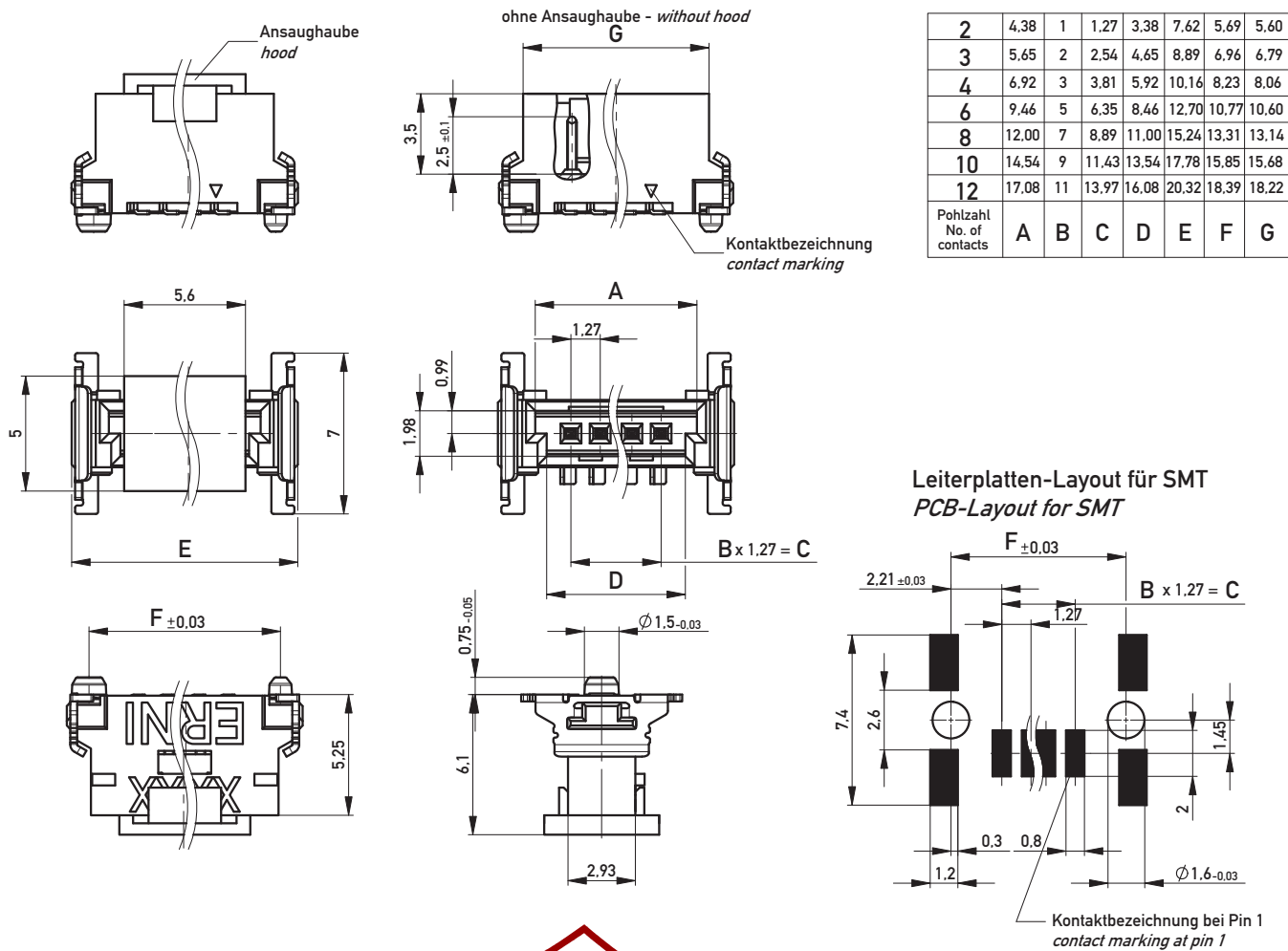

All dimensions in mm.



Tel.: (+34) 902 450 160  
Fax: (+34) 902 433 088  
[ermec@ermec.com](mailto:ermec@ermec.com)  
[www.ermec.com](http://www.ermec.com)

**1.27 mm SRC**  
**Single Row Connector - MiniBridge™ Cable System**  
**Vertical Male Type P**

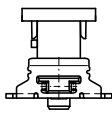
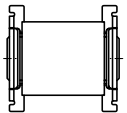
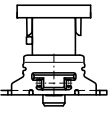
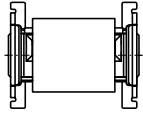
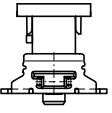
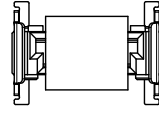
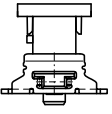
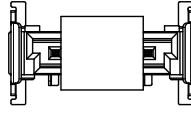
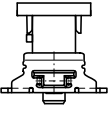
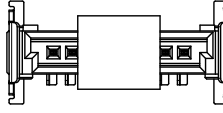
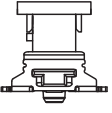
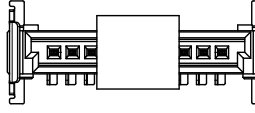
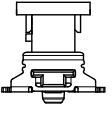
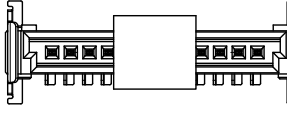

**Ordering Information**

No. of Pins	Termination	Packaging	Part Number
			
2	SMT	Tape and reel/650 pcs	<b>284695</b>
			
3	SMT	Tape and reel/650 pcs	<b>284696</b>
			
4	SMT	Tape and reel/650 pcs	<b>284697</b>
			
6	SMT	Tape and reel/650 pcs	<b>284698</b>
			
8	SMT	Tape and reel/650 pcs	<b>284699</b>
			
10	SMT	Tape and reel/650 pcs	<b>294919</b>
			
12	SMT	Tape and reel/650 pcs	<b>294920</b>

# 1.27 mm SRC

## Single Row Connector - MiniBridge™ Cable System

### Packaging



#### Right Angle and Vertical Male Connectors 2, 3, 4 and 6 Pins

Verpackt in Gurtverpackung

- Tape on Reel Packaging

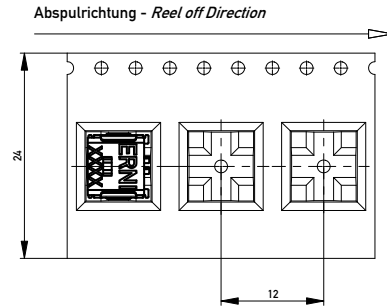
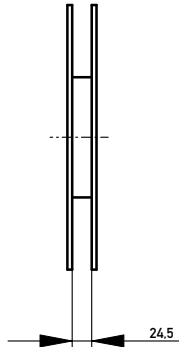
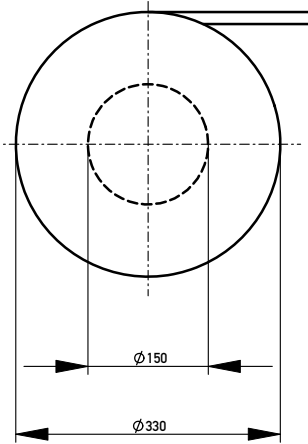

#### Right Angle and Vertical Male Connectors 8 and 10 Pins

Verpackt in Gurtverpackung

- Tape on Reel Packaging

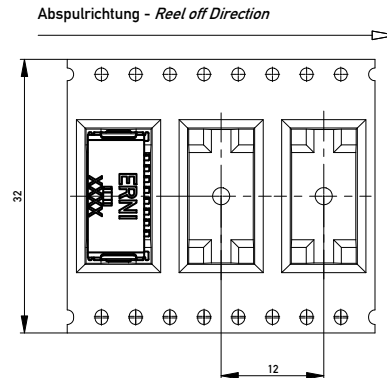
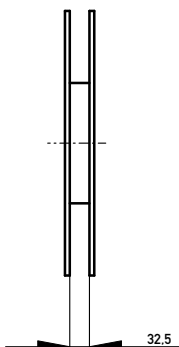
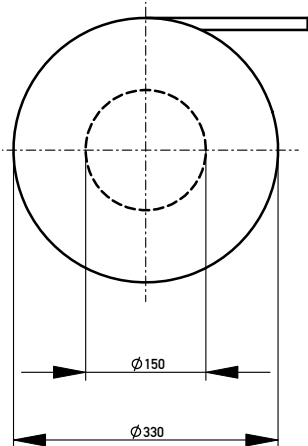

#### Right Angle and Vertical Male Connectors 12 Pins

Verpackt in Gurtverpackung

- Tape on Reel Packaging

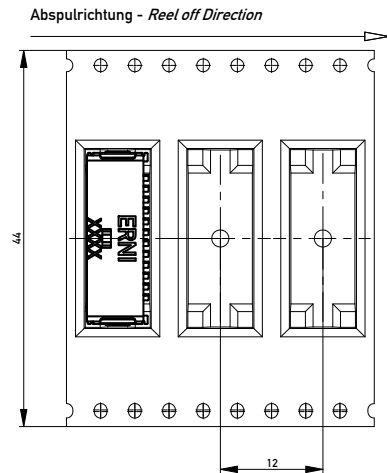
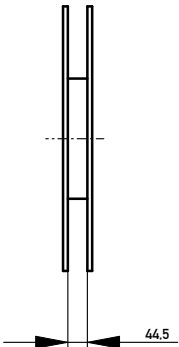
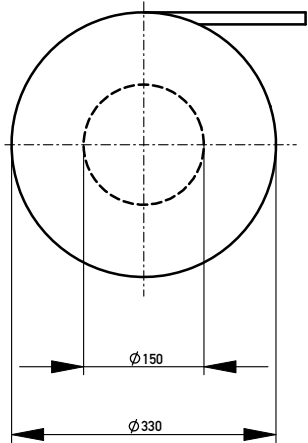



# 1.27 mm SRC Single Row Connector - MiniBridge™ Cable System Cable Assemblies



Standard cable assemblies are available from ERNI. Thanks to the versatile options of our female connectors, the widest range of applications can be realized. The female connectors are available with different types of locking latches for normal vibration/shock loads (black model) as well as applications involving heavy vibration/shock loads (red model). The robust version (red) is only unlockable with a sharp item, e.g. tip of pen. The IDC terminal is designed for AWG-24 or AWG-26 conductors (solid or stranded). Partial loading is also possible using single wire. Cable outlet is 90° or 180°.

## Dimensional Drawing

### Female Connector Cable Outlet 90°

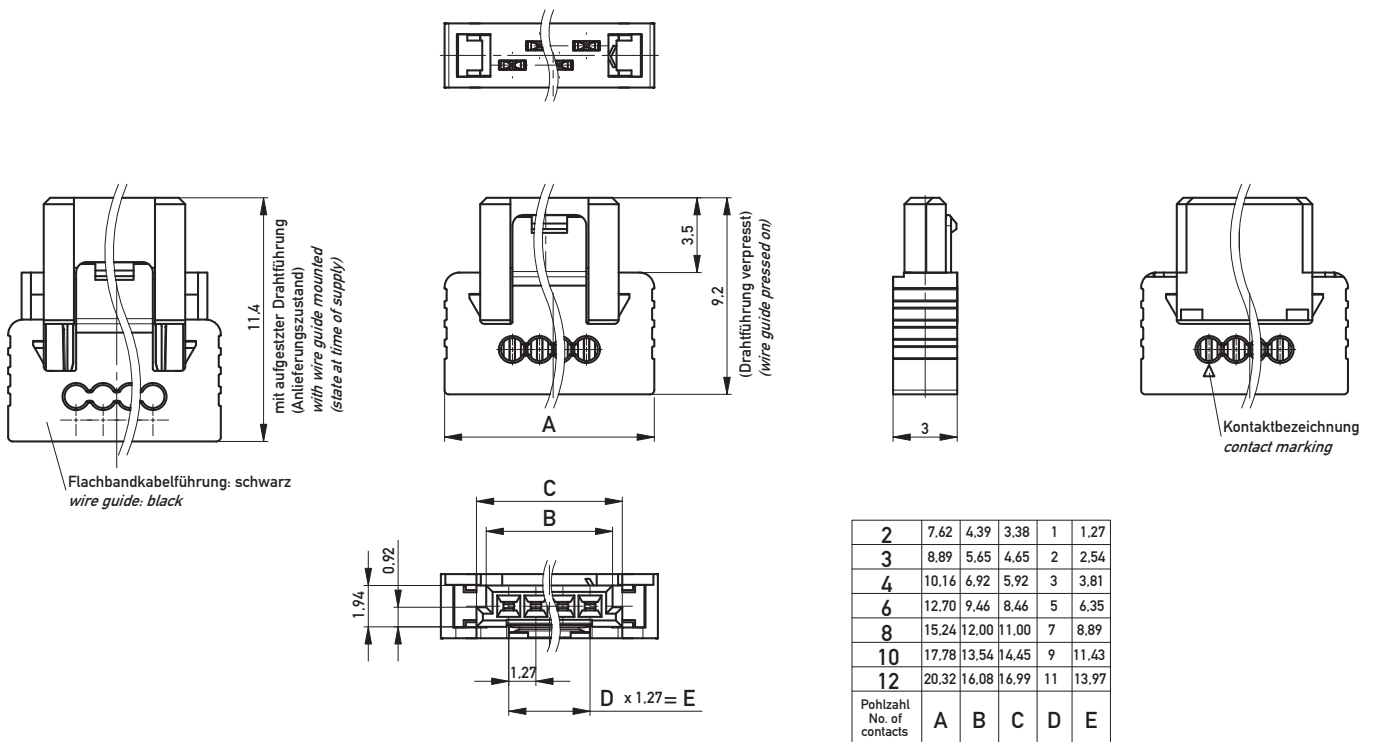

All dimensions in mm.



Tel.: (+34) 902 450 160  
Fax: (+34) 902 433 088  
[ermec@ermec.com](mailto:ermec@ermec.com)  
[www.ermec.com](http://www.ermec.com)

1.27 mm SRC  
 Single Row Connector - MiniBridge™ Cable System  
 Cable Assemblies



Dimensional Drawing

Female Connector Cable Outlet 180°

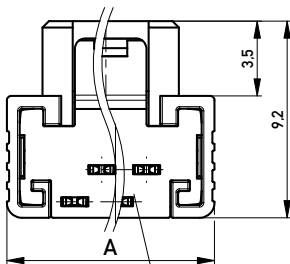
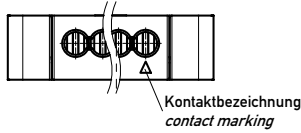

Flachbandkabelführung: rot  
 wire guide: red

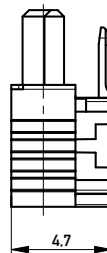

mit aufgesetzter  
 Drahtführung  
 (Anlieferungszustand)  
 with wire guide mounted  
 (state at time of supply)



Drahtführung verpresst  
 (wire guide pressed on)

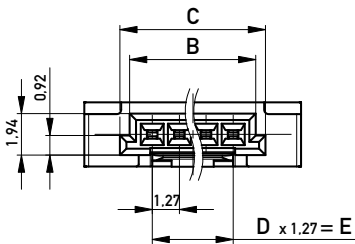

2	7.62	4.39	3.38	1	1.27
3	8.89	5.65	4.65	2	2.54
4	10.16	6.92	5.92	3	3.81
6	12.70	9.46	8.46	5	6.35
8	15.24	12.00	11.00	7	8.89
10	17.78	13.54	14.45	9	11.43
12	20.32	16.08	16.99	11	13.97
Polzahl No. of contacts	A	B	C	D	E

Dimensional Drawing Ribbon Cable

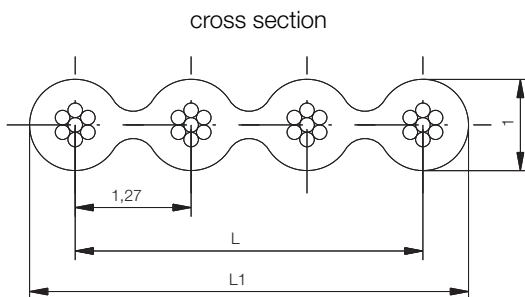

Distribución de componentes  
 eléctricos y electrónicos

Tel.: (+34) 902 450 160  
 Fax: (+34) 902 433 088  
[ermec@ermec.com](mailto:ermec@ermec.com)  
[www.ermec.com](http://www.ermec.com)

13,97	13,97	12
11,43	12,43	10
8,89	9,89	8
6,35	7,35	6
3,81	4,81	4
2,54	3,54	3
1,27	2,27	2
L	L1	Polzahl Number of Conductors

All dimensions in mm.

# 1.27 mm SRC

## Single Row Connector - MiniBridge™ Cable System

### Cable Assemblies



#### Ordering Information

No. of Pins	Length	Cable Type (AWG-26)	Connector 1	Connector 2	Part Number
2	100 mm	PVC	SFX	SFX	<b>839010</b>
2	200 mm	PVC	SFX	SFX	<b>839011</b>
2	300 mm	PVC	SFX	SFX	<b>839012</b>
3	100 mm	PVC	SFX	SFX	<b>839013</b>
3	200 mm	PVC	SFX	SFX	<b>839014</b>
3	300 mm	PVC	SFX	SFX	<b>839015</b>
4	100 mm	PVC	SFX	SFX	<b>839016</b>
4	200 mm	PVC	SFX	SFX	<b>839017</b>
4	300 mm	PVC	SFX	SFX	<b>839018</b>
6	100 mm	PVC	SFX	SFX	<b>839019</b>
6	200 mm	PVC	SFX	SFX	<b>839020</b>
6	300 mm	PVC	SFX	SFX	<b>839021</b>
8	100 mm	PVC	SFX	SFX	<b>839022</b>
8	200 mm	PVC	SFX	SFX	<b>839023</b>
8	300 mm	PVC	SFX	SFX	<b>839024</b>
10	100 mm	PVC	SFX	SFX	<b>839162</b>
10	200 mm	PVC	SFX	SFX	<b>839163</b>
10	300 mm	PVC	SFX	SFX	<b>839164</b>
12	100 mm	PVC	SFX	SFX	<b>839165</b>
12	200 mm	PVC	SFX	SFX	<b>839166</b>
12	300 mm	PVC	SFX	SFX	<b>839167</b>



**ERMEC, S.L. BARCELONA**  
 C/ Francesc Teixidó, 22  
 E-08918 Badalona  
 (Spain)

**Tel.: (+34) 902 450 160**  
**Fax: (+34) 902 433 088**  
[info@ermec.com](mailto:info@ermec.com)  
[www.ermec.com](http://www.ermec.com)

**ERMEC, S.L. MADRID**  
 C/ Sagasta, 8, 1ª planta  
 E-28004 Madrid  
 (Spain)

**PORTUGAL**  
[portugal@ermec.com](mailto:portugal@ermec.com)  
**BILBAO**  
[bilbao@ermec.com](mailto:bilbao@ermec.com)

**1.27 mm SRC**  
**Single Row Connector - MiniBridge™ Cable System**  
**Cable Assemblies**



**Ordering Information**

No. of Pins	Length	Cable Type (AWG-26)	Connector 1	Connector 2	Part Number
2	100 mm	PVC	AFU	AFU	839025
2	200 mm	PVC	AFU	AFU	839026
2	300 mm	PVC	AFU	AFU	839027
3	100 mm	PVC	AFU	AFU	839028
3	200 mm	PVC	AFU	AFU	839029
3	300 mm	PVC	AFU	AFU	839030
4	100 mm	PVC	AFU	AFU	839031
4	200 mm	PVC	AFU	AFU	839032
4	300 mm	PVC	AFU	AFU	839033
6	100 mm	PVC	AFU	AFU	839034
6	200 mm	PVC	AFU	AFU	839035
6	300 mm	PVC	AFU	AFU	839036
8	100 mm	PVC	AFU	AFU	839037
8	200 mm	PVC	AFU	AFU	839038
8	300 mm	PVC	AFU	AFU	839039
10	100 mm	PVC	AFU	AFU	839168
10	200 mm	PVC	AFU	AFU	839169
10	300 mm	PVC	AFU	AFU	839170
12	100 mm	PVC	AFU	AFU	839171
12	200 mm	PVC	AFU	AFU	839172
12	300 mm	PVC	AFU	AFU	839173

**ERMEC**  
www.ermec.com  
**ERMEC, S.L. BARCELONA**  
 C/ Francesc Teixidó, 22  
 E-08918 Badalona  
 (Spain)

**Tel.: (+34) 902 450 160**  
**Fax: (+34) 902 433 088**  
[info@ermec.com](mailto:info@ermec.com)  
[www.ermec.com](http://www.ermec.com)

**ERMEC, S.L. MADRID**  
 C/ Sagasta, 8, 1ª planta  
 E-28004 Madrid  
 (Spain)

**PORTUGAL**  
[portugal@ermec.com](mailto:portugal@ermec.com)  
**BILBAO**  
[bilbao@ermec.com](mailto:bilbao@ermec.com)

# 1.27 mm SRC

## Single Row Connector - MiniBridge™ Cable System

### Cable Assemblies



#### Ordering Information

No. of Pins	Length	Cable Type (AWG-26)	Connector 1	Connector 2	Part Number
2	100 mm	PVC	SFX	AFU	839040
2	200 mm	PVC	SFX	AFU	839041
2	300 mm	PVC	SFX	AFU	839042
3	100 mm	PVC	SFX	AFU	839043
3	200 mm	PVC	SFX	AFU	839044
3	300 mm	PVC	SFX	AFU	839045
4	100 mm	PVC	SFX	AFU	839046
4	200 mm	PVC	SFX	AFU	839047
4	300 mm	PVC	SFX	AFU	839048
6	100 mm	PVC	SFX	AFU	839049
6	200 mm	PVC	SFX	AFU	839050
6	300 mm	PVC	SFX	AFU	839051
8	100 mm	PVC	SFX	AFU	839052
8	200 mm	PVC	SFX	AFU	839053
8	300 mm	PVC	SFX	AFU	839054
10	100 mm	PVC	SFX	AFU	839174
10	200 mm	PVC	SFX	AFU	839175
10	300 mm	PVC	SFX	AFU	839176
12	100 mm	PVC	SFX	AFU	839177
12	200 mm	PVC	SFX	AFU	839178
12	300 mm	PVC	SFX	AFU	839179

**ERMEC**  
 ERMEC, S.L. BARCELONA  
 C/ Francesc Teixidó, 22  
 E-08918 Badalona  
 (Spain)

Tel.: (+34) 902 450 160  
 Fax: (+34) 902 433 088  
[info@ermec.com](mailto:info@ermec.com)  
[www.ermec.com](http://www.ermec.com)

ERMEC, S.L. MADRID  
 C/ Sagasta, 8, 1ª planta  
 E-28004 Madrid  
 (Spain)

PORTUGAL  
[portugal@ermec.com](mailto:portugal@ermec.com)  
 BILBAO  
[bilbao@ermec.com](mailto:bilbao@ermec.com)

# 1.27 mm SRC

## Single Row Connector - MiniBridge™ Cable System

### Cable Assemblies



#### Order Code

IDCCS\_SRC\_1.27\_□□\_□□□\_□□□\_□□□\_□□

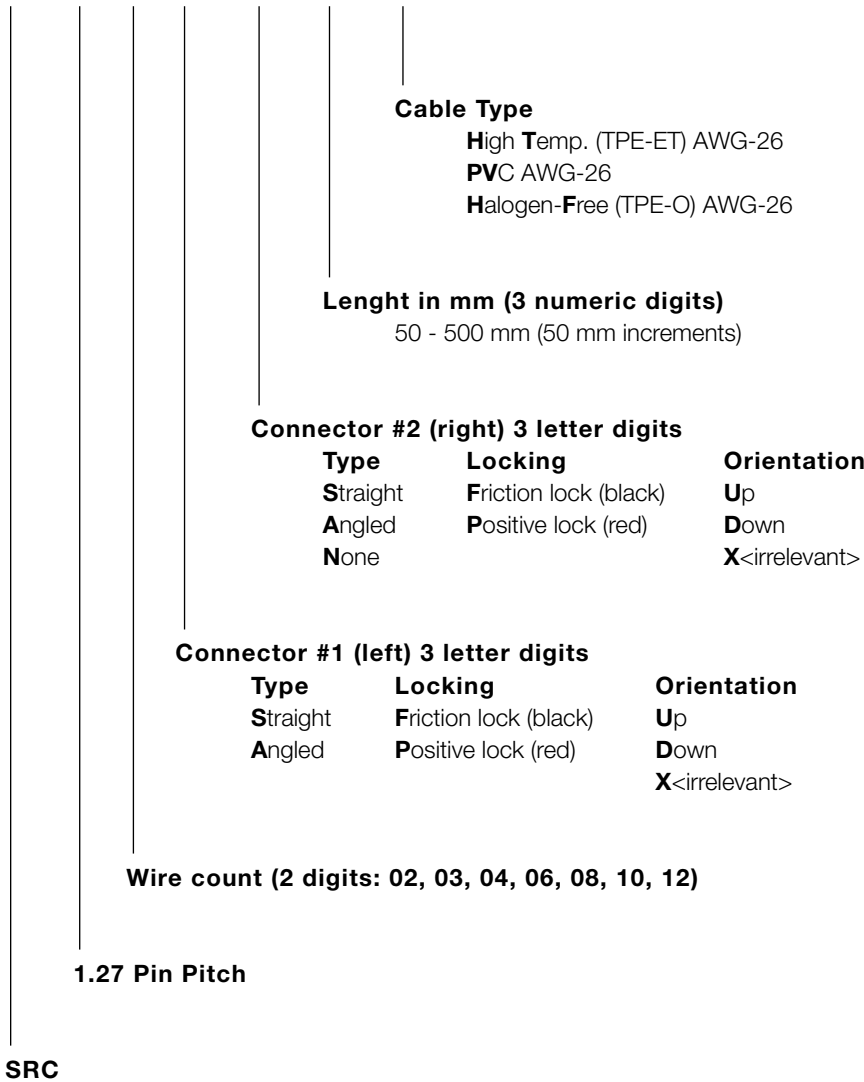

Note:

Please use the order code for orderings differing to the standard cable assemblies. A part number will be specified during series order.

# 1.27 mm SRC Single Row Connector MiniBridge™ Cable System



## Part Number Index

Part Number	Page	Part Number	Page
214011	12	839045	20
214012	12	839046	20
214013	12	839047	20
214014	12	839048	20
234450	12	839049	20
234464	12	839050	20
234478	12	839051	20
284695	14	839052	20
284696	14	839053	20
284697	14	839054	20
284698	14	839162	18
284699	14	839163	18
294919	14	839164	18
294920	14	839165	18
839010	18	839166	18
839011	18	839167	18
839012	18	839168	19
839013	18	839169	19
839014	18	839170	19
839015	18	839171	19
839016	18	839172	19
839017	18	839173	19
839018	18	839174	20
839019	18	839175	20
839020	18	839176	20
839021	18	839177	20
839022	18	839178	20
839023	18	839179	20
839024	18		
839025	19		
839026	19		
839027	19		
839028	19		
839029	19		
839030	19		
839031	19		
839032	19		
839033	19		
839034	19		
839035	19		
839036	19		
839037	19		
839038	19		
839039	19		
839040	20		
839041	20		
839042	20		
839043	20		
839044	20		

**ERMEC** ERMEC, S.L. BARCELONA  
C/ Francesc Teixidó, 22  
E-08918 Badalona  
(Spain)

Tel.: (+34) 902 450 160  
Fax: (+34) 902 433 088  
[info@ermec.com](mailto:info@ermec.com)  
[www.ermec.com](http://www.ermec.com)

ERMEC, S.L. MADRID  
C/ Sagasta, 8, 1ª planta  
E-28004 Madrid  
(Spain)

PORTUGAL  
[portugal@ermec.com](mailto:portugal@ermec.com)  
BILBAO  
[bilbao@ermec.com](mailto:bilbao@ermec.com)





Member



VMEbus INTERNATIONAL TRADE ASSOCIATION



ERMEC, S.L. BARCELONA  
C/ Francesc Teixidó, 22  
E-08918 Badalona  
(Spain)



Tel.: (+34) 902 450 160  
Fax: (+34) 902 433 088  
[info@ermec.com](mailto:info@ermec.com)  
[www.ermec.com](http://www.ermec.com)

ERMEC, S.L. MADRID  
C/ Sagasta, 8, 1ª planta  
E-28004 Madrid  
(Spain)

PORTUGAL  
[portugal@ermec.com](mailto:portugal@ermec.com)  
BILBAO  
[bilbao@ermec.com](mailto:bilbao@ermec.com)

[www.erni.com](http://www.erni.com)



<b>ERMEC, S.L. BARCELONA</b> C/ Francesc Teixidó, 22 E-08918 Badalona (Spain)	 Distribución de componentes eléctricos y electrónicos	<b>Tel.: (+34) 902 450 160</b> <b>Fax: (+34) 902 433 088</b> <a href="mailto:info@ermec.com">info@ermec.com</a> <a href="http://www.ermec.com">www.ermec.com</a>	<b>ERMEC, S.L. MADRID</b> C/ Sagasta, 8, 1ª planta E-28004 Madrid (Spain)	<b>PORTUGAL</b> <a href="mailto:portugal@ermec.com">portugal@ermec.com</a> <b>BILBAO</b> <a href="mailto:bilbao@ermec.com">bilbao@ermec.com</a>
--	--	---	--	--

**ERNI Electronics GmbH**  
Seestrasse 9  
73099 Adelberg/Germany  
Tel +49 7166 50-0  
Fax +49 7166 50-282  
info@erni.de

Europe South America Africa Japan

**ERNI Electronics, Inc.**  
2201 Westwood Ave  
Richmond, VA 23230/USA  
Tel +1 804 228-4100  
Fax +1 804 228-4099  
info.usa@erni.com

North America Canada Mexico

**ERNI Asia Holding Pte Ltd.**  
Blk 4008 Ang Mo Kio Avenue 10  
#04-01/02 Techplace I  
Singapore 569625  
Tel +65 6 555 5885  
Fax +65 6 555 5995  
info@erni-asia.com

Asia

[www.erni.com](http://www.erni.com)

© ERNI Electronics GmbH 2009 • Printed in Germany. A policy of continuous improvement is followed and the right to alter any published data without notice is reserved.  
ERNI®, MicroStac®, MicroSpeed®, MiniBridge®, MaxiBridge®, ERmet®, ERmet ZD®, ERbic® and ERNIPRESS® are trademarks (registered or applied for in various countries) of ERNI Electronics GmbH.