

Pushbutton switches for harsh environments - short case - bushing Ø 12 mm - momentary

Distinctive features and specifications



- Momentary with short case, reduced behind-panel depth
- Tactile feedback
- Flat round actuator for optional marking
- Glossy actuator option (round curved only)
- Sealed to IP67

ENVIRONMENTAL SPECIFICATIONS

- Front panel sealing : IP67 according to IEC 60529
- Shock resistance : 100 g according to IEC 512-4, test 6c
- Vibration resistance : 10-500Hz - 10 g according to IEC 512-4, test 6d
- Salt spray : IEC 512-6, test 11f
- Robustness : IK06 according to EN 50102 (1 joule)
- Operating temperature : -40°C to +85°C

GENERAL SPECIFICATIONS

- Panel thickness : 1,5 mm (.059) min. 4 mm (.157 max.)
- Total travel : 1,7 mm (.067)+/- 0,3 mm
- Typical operating force : 4N +/- 2N
- Mechanical life : 1.000.000 cycles
- Torque : 1,5 Nm max. applied to nut
- Soldering : 320°C max. for 3 sec.

ELECTRICAL SPECIFICATIONS

- Max. current/voltage rating with resistive load :
0,2A 48VDC, 500.000 cycles
0,5A 48VAC, 500.000 cycles
- Initial contact resistance : 50 mΩ max.
- Insulation resistance : 1 GΩ min. at 500VDC
- Dielectric strength : 1.500 Vrms 50 HZ between terminals

MATERIALS

- Case : thermoplastic UL94-V0
- Actuator : polyamide 6/6
- Bushing/bezel : zinc die-cast (zamac), black painted
- Contacts : brass, gold plated
- Multi-wire lead AWG20, section 0,6 mm²
- Terminal seal : epoxy

MOUNTING

Panel cut-out

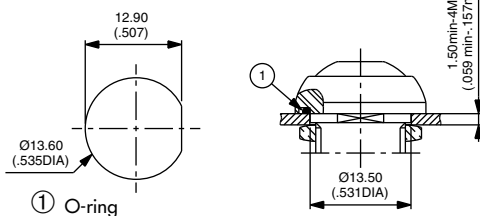

Matrix mounting

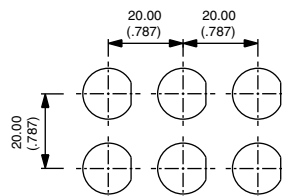

Back of panel space requirement

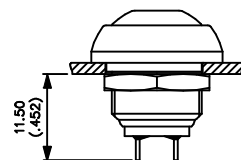

ERMEC, S.L. BARCELONA
C/ Francesc Teixidó, 22
E-08918 Badalona
(Spain)

Tel.: (+34) 902 450 160
Fax: (+34) 902 433 088
info@ermec.com
www.ermec.com

ERMEC, S.L. MADRID
C/ Sagasta, 8, 1ª planta
E-28004 Madrid
(Spain)

PORTUGAL
portugal@ermec.com
BILBAO
bilbao@ermec.com

IC series

Pushbutton switches for harsh environments - short case - bushing Ø 12 mm - momentary

Overview

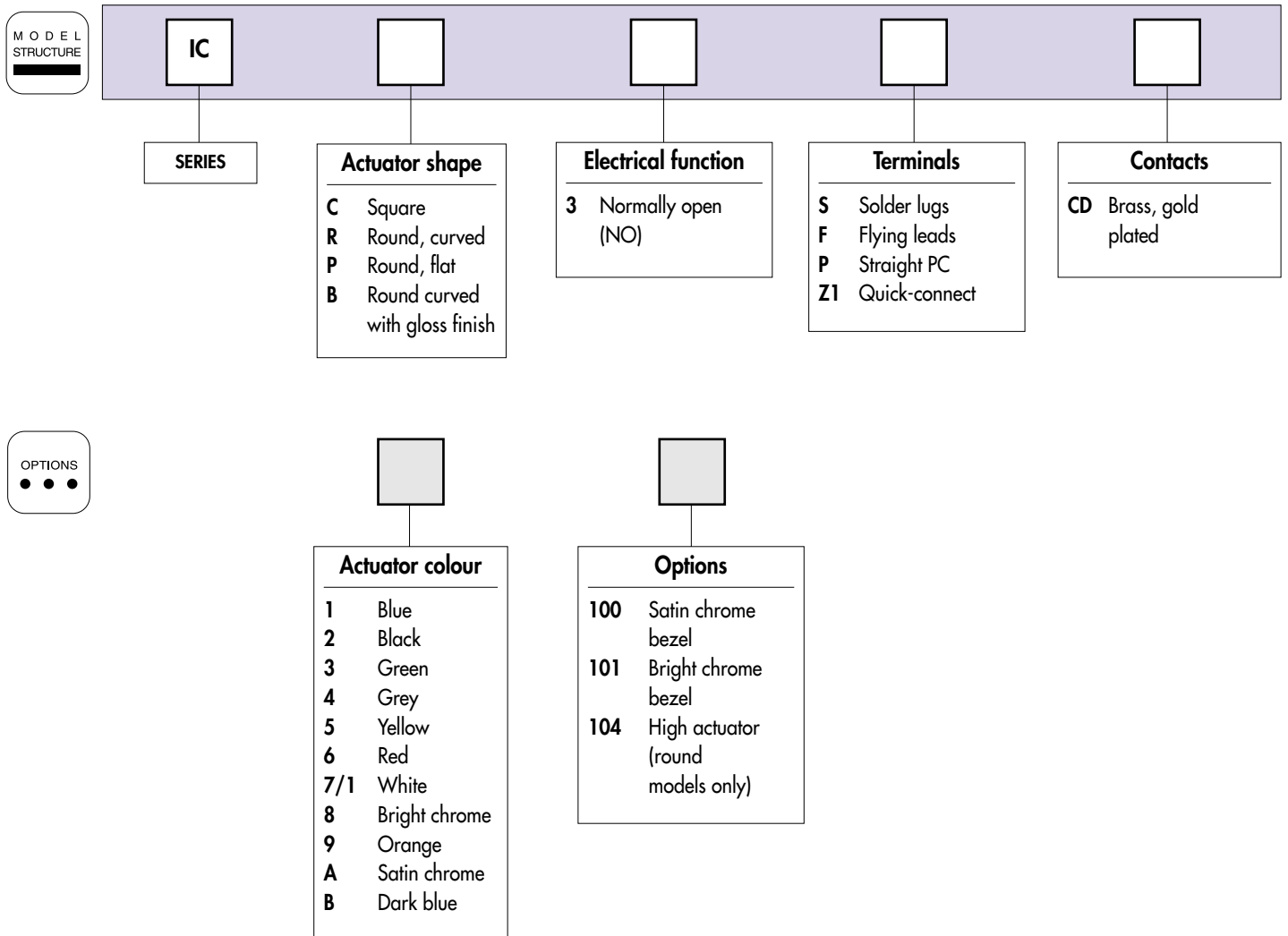

ABOUT THIS SERIES

On the following pages, you will find successively :
model structure of switches and options in the same order as in above chart

Dimensions : first dimensions are in mm while inches are shown as bracketed numbers.



NOTICE : please note that not all combinations of above numbers are available. Refer to the following pages for further information.



A sealing boot is available to protect the switches against frost and sand. It is presented at the end of this catalogue.



Mounting accessories : Standard hardware supplied : 1 hex nut 14 mm (.551) across flats and 1 O-ring. Hex nut part number U166.



Packaging unit : 25 pieces

IC series

Pushbutton switches for harsh environments - short case - bushing \varnothing 12 mm - momentary

Square

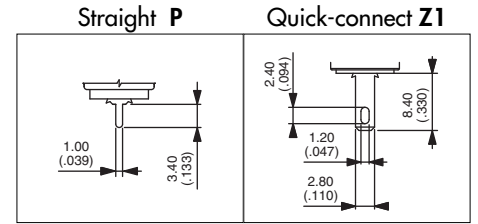
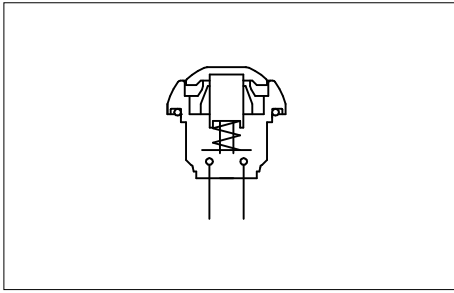

MODEL STRUCTURE

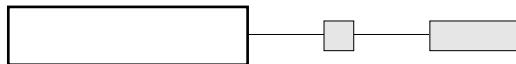

Solder lug terminals

→ Flat



ICC3SCD



Normally Open

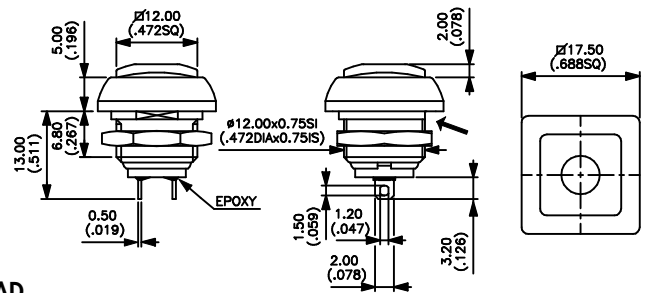

Also available with straight PC terminals : **ICC3PAD**
and quick-connect terminals : **ICC3Z1AD**

Sealed flying lead terminals

→ Flat



ICC3FCD



Normally Open

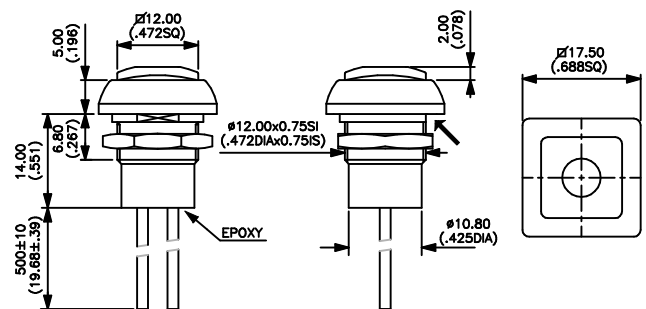

Wire colours (NC/NO) : black : NO, blue : NC

ACTUATOR COLOUR

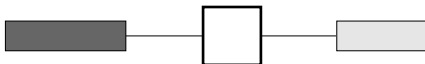

1 : blue - 2 : black - 3 : green - 4 : grey - 5 : yellow - 6 : red - 7/1 : white - 8 : bright chrome - 9 : orange
A : satin chrome - B : dark blue

OPTIONS

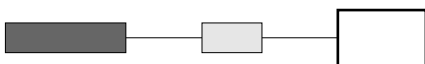

100 : Satin chrome bezel
101 : Bright chrome bezel

IC series

Pushbutton switches for harsh environments - short case - bushing Ø 12 mm - momentary

Round

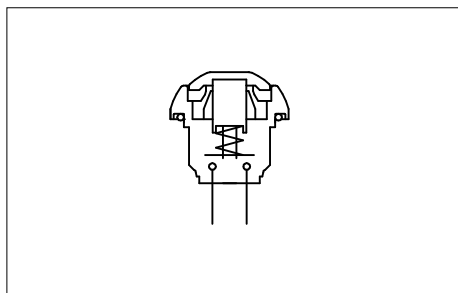

• **Gloss actuator finish**
Curved actuator also available with gloss finish - replace ICR by ICB in the part numbers below.

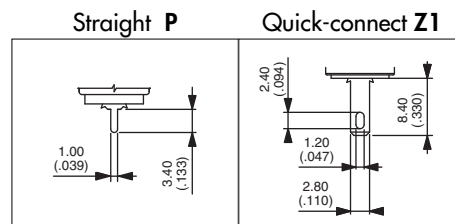

MODEL STRUCTURE

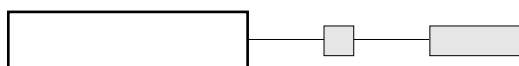

Actuator marking available on ICP models (symbol 10 mm max.). On request.

Solder lug terminals

→ Flat



Curved actuator
ICR3SCD



Flat actuator
ICP3SCD

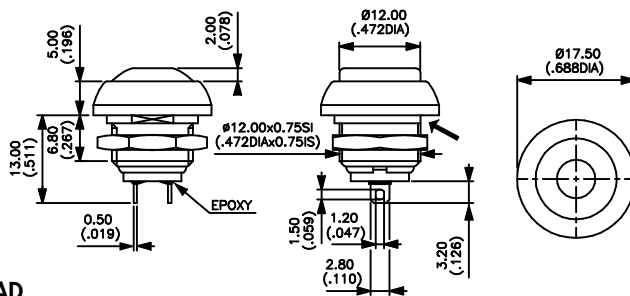

Also available with straight PC terminals : **IC•3PAD**
and quick-connect terminals : **IC•3Z1AD**

Sealed flying lead terminals

→ Flat



Curved actuator
ICR3FCD



Flat actuator
ICP3FCD

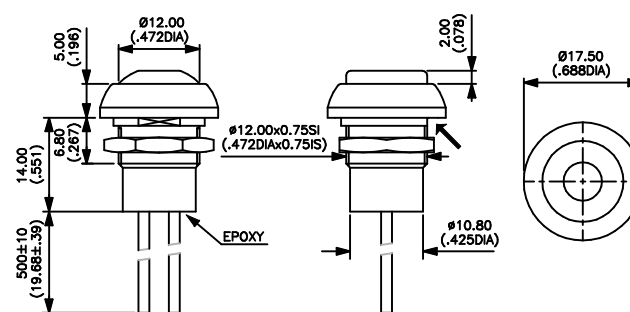

Wire colours (NC/NO) : black : NO, blue : NC

ACTUATOR COLOUR

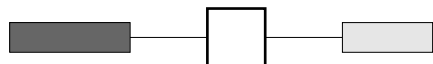

1 : blue - 2 : black - 3 : green - 4 : grey - 5 : yellow
6 : red - 7/1 : white - 8 : bright chrome - 9 : orange
A : satin chrome - B : dark blue -

OPTIONS

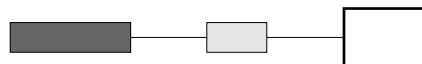

100 : Satin chrome bezel
101 : Bright chrome bezel
104 : High actuator

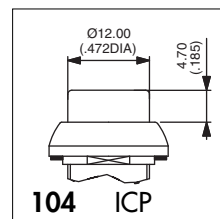
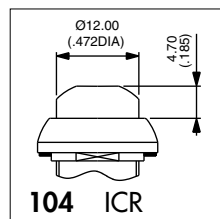

IC1201-A-prelim.