

10 MILLION ACTUATIONS

IP 67 SEALING

NORMAL OPEN (NO) OR NORMAL CLOSED (NC/NO)

THROUGH-HOLE RIGHT ANGLE VERSION

QUIET CONTACT OPTION WITH 2.0N

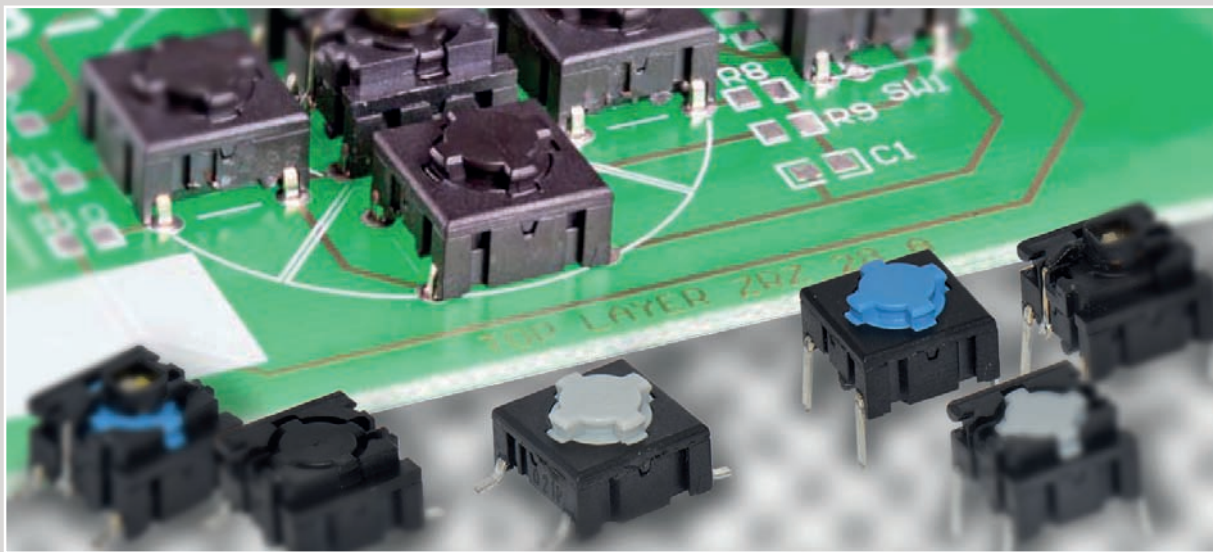

multimec[®] 5 series is the new generation of 3A, 3F, 4A and 4F switch. In principle the multimec[®] 5 series is very similar to the 3 series - it has the same pin layout, the same dimensions and the same electrical specifications.

The four main updates are the cap retention system and actuator, three standard actuation forces, one temperature range and possibility of normal closed/normal open function.



5E

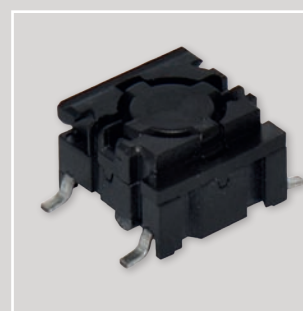

5G



- Through-hole (TH) or surface mount (SMD)
- 50mA/24VDC
- Single pole/momentary
- 10,000,000 operations lifetime
- Temperature range:
 - Switch: -40/+160°C
 - LED: -40/+85°C
- IP 67 sealing
- Actuation force: 2.0N, 3.5N, 6.5N
- NO or NC/NO

All dimensions in mm

THROUGH-HOLE (TH)

5G

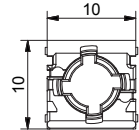
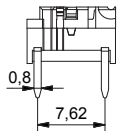
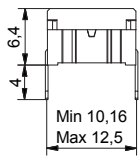

5G illuminated

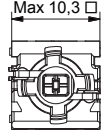
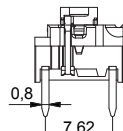
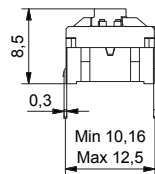

5E

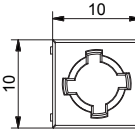
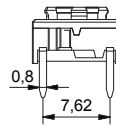
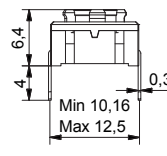

PCB LAYOUT

Non-illuminated

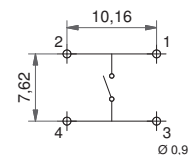

1 LED

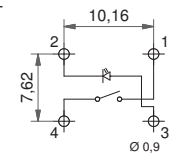

2 LED

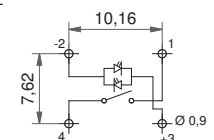

SURFACE MOUNT (SMD)

5G

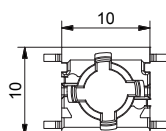
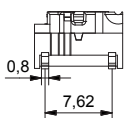
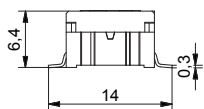

5G illuminated

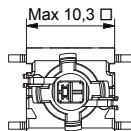
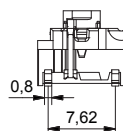
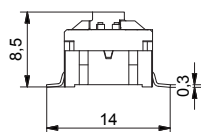

5E

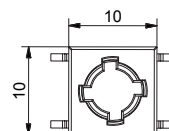
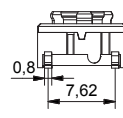
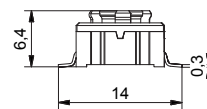

PCB LAYOUT

Non-illuminated

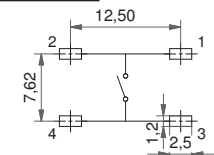

1 LED

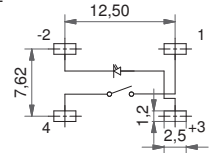

2 LED

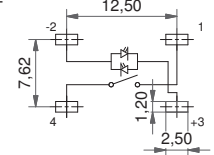

NORMAL CLOSED/NORMAL OPEN FUNCTION

- Available for 5E and non-illuminated 5G in all standard actuation forces.
- Has the same PCB layout as the NO 5E and 5G
- The housing of a NC/NO switch is grey

ERMEC, S.L. BARCELONA
C/ Francesc Teixidó, 22
E-08918 Badalona
(Spain)

Tel.: (+34) 902 450 160
Fax: (+34) 902 433 088
info@ermec.com
www.ermec.com

ERMEC, S.L. MADRID
C/ Sagasta, 8, 1ª planta
E-28004 Madrid
(Spain)

PORTUGAL
portugal@ermec.com
BILBAO
bilbao@ermec.com

CIRCUIT DIAGRAM

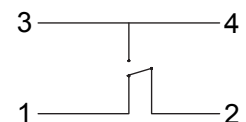

RIGHT ANGLE SWITCHES

PCB LAYOUT

5E

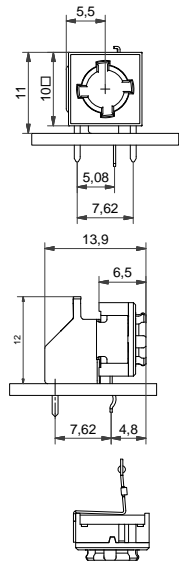

5G

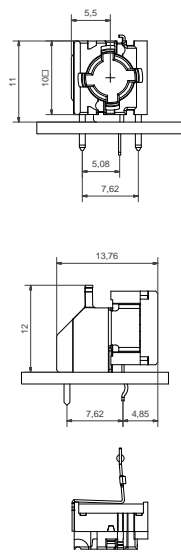

5G + 1SS

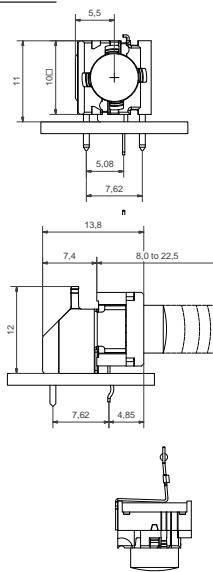

5G + 1DS

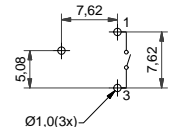
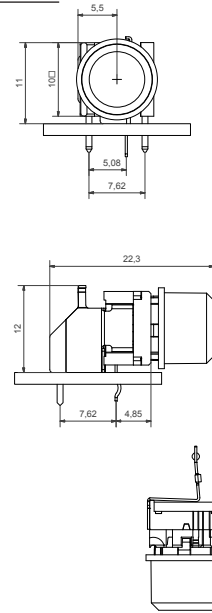

multimec® 5 series has only normal open (NO) non-illuminated right angle switch.

ILLUMINATED – HOW TO ORDER

Switch	Mounting	Actuation force	LED	Quiet (optional)
5 G	<input type="checkbox"/> <input type="checkbox"/> <input type="checkbox"/>	<input type="checkbox"/> <input type="checkbox"/> <input type="checkbox"/>	<input type="checkbox"/> <input type="checkbox"/> <input type="checkbox"/>	<input type="checkbox"/>
	TH9 through-hole SH9 surface mount	20 35 65	01 blue 22 green 42 yellow 61 white	Q only for 2.0N
			82 red 2242 green/yellow 8222 red/green 8242 red/yellow	

NON-ILLUMINATED – HOW TO ORDER

Switch	Mounting	Actuation force	RAS (optional)	NCNO (optional)
5 E	<input type="checkbox"/> <input type="checkbox"/> <input type="checkbox"/>	<input type="checkbox"/> <input type="checkbox"/> <input type="checkbox"/>	<input type="checkbox"/> <input type="checkbox"/> <input type="checkbox"/>	<input type="checkbox"/> <input type="checkbox"/> <input type="checkbox"/>
	TH9 through-hole SH9 surface mount	20 20Q 35 65	right angle switch	right angle switch

Switch	Mounting	Actuation force	RAS (optional)	NCNO (optional)
5 G	<input type="checkbox"/> <input type="checkbox"/> <input type="checkbox"/>	<input type="checkbox"/> <input type="checkbox"/> <input type="checkbox"/>	<input type="checkbox"/> <input type="checkbox"/> <input type="checkbox"/>	<input type="checkbox"/> <input type="checkbox"/> <input type="checkbox"/>
	TH9 through-hole SH9 surface mount	20 20Q 35 65	right angle switch	right angle switch

ERMEC, S.L. BARCELONA
C/ Francesc Teixidó, 22
E-08918 Badalona
(Spain)

Tel.: (+34) 902 450 160
Fax: (+34) 902 433 088
info@ermec.com
www.ermec.com

ERMEC, S.L. MADRID
C/ Sagasta, 8, 1ª planta
E-28004 Madrid
(Spain)

PORTUGAL
portugal@ermec.com
BILBAO
bilbao@ermec.com

Ordering example: 5ESH935 (non-illuminated), 5GTH9658222 (illuminated), 5GSH935NCNO (normal closed/normal open); 5ETH920RAS (right angle) 5ETH920Q or 5GSH92061Q (quiet versions)

Please see colour codes, updates of products and changes of specifications on www.mec.dk



- Through-hole (TH) or surface mount (SMD)
- 50mA/24VDC
- Single pole/momentary
- 10,000,000 operations lifetime
- Temperature range:
 - Low temp.: -40/+115C
 - High temp.: -40/+160C
- IP 67 sealing
- Actuation force: 3.5N

All dimensions in mm

THROUGH-HOLE (TH)

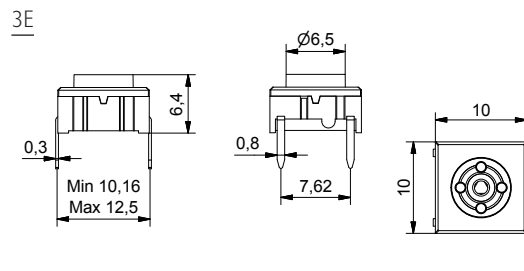
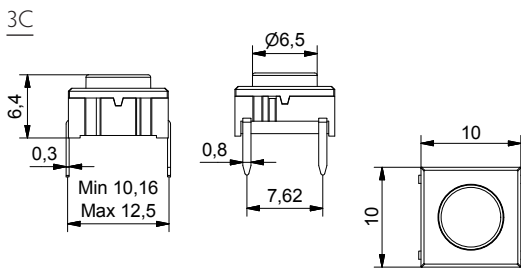

PCB LAYOUT

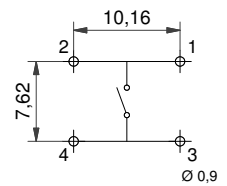

SURFACE MOUNT (SMD)

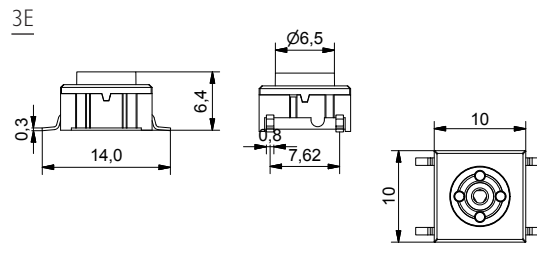
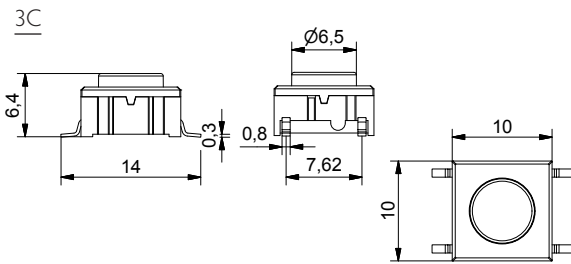

PCB LAYOUT

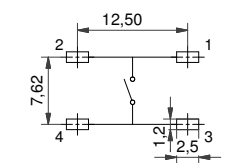

3FTL6RAS W/LED

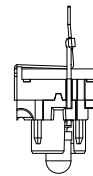
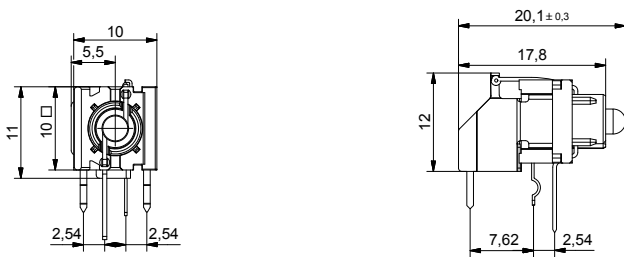

PCB LAYOUT

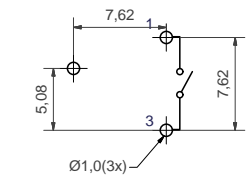

HOW TO ORDER

Switch	Mounting	Temperature range
3 C	<input type="checkbox"/> T through-hole <input type="checkbox"/> S surface mount	<input type="checkbox"/> L6 low temp. white <input type="checkbox"/> L9 low temp. black <input type="checkbox"/> H9 high temp.

Switch	Mounting	Temperature range
3 E	<input type="checkbox"/> T through-hole <input type="checkbox"/> S surface mount	<input type="checkbox"/> L9 low temp. black <input type="checkbox"/> H9 high temp.

Switch	LED
3 F T L 6	<input type="checkbox"/> 00 blue <input type="checkbox"/> 20 green <input type="checkbox"/> 40 yellow

Right angle support
R A S

3FTL6RAS with LED can be used with the 3 series keycaps: 1D, 1E, 1F, 1K, 1N, 1Q, 1R, 1S, 1T, 1U, 1V, 1WA, 1WD, 1WP, 1X. Ask further information on caps from MEC.

Ordering example: 3CTL6, 3ESH9, 3FTL6RAS Please see colour codes, updates of products and changes of specifications on www.mec.dk

Tape & Reel

Tape and reel is available for the parts listed and has the following specifications:

Reel diameter:	Ø330mm	Tape and reel material:	antistatic or better
Tape width:	24mm	Quantity per reel:	see list
Pitch:	see list		

3C/3E/5E/5G multimec® tape & reel

Part No.	Ordering Code	Pitch	Quantity per reel
3CSH9	3CSH9R	16	500
3ESH9	3ESH9R	16	500
5ESH9XX	5ESH9XXR	16	500
5GSH9XX	5GSH9XXR	16	500
5XSH9XX1SSXX-08.0	5XSH9XXR1SSXX-08.0	20	250
5XSH9XX1SSXX-09.5	5XSH9XXR1SSXX-09.5	20	250
5XSH9XX1SSXX-10.4	5XSH9XXR1SSXX-10.4	20	250
5XSH9XX1SSXX-11.0	5XSH9XXR1SSXX-11.0	20	250
5XSH9XX1SSXX-12.0	5XSH9XXR1SSXX-12.0	20	250
All varimec below R after part no. 12.5			20 250

illuminated 5G multimec® tape & reel

Part No.	Ordering Code	Pitch	Quantity per reel
5GSH9XX01	5GSH9XX01R	20	250
5GSH9XX22	5GSH9XX22R	20	250
5GSH9XX42	5GSH9XX42R	20	250
5GSH9XX61	5GSH9XX61R	20	250
5GSH9XX82	5GSH9XX82R	20	250
5GSH9XX2242	5GSH9XX2242R	20	250
5GSH9XX8222	5GSH9XX8222R	20	250
5GSH9XX8242	5GSH9XX8242R	20	250

How to assemble

multimec®
5GT+1A/H

multimec®
5GT+1B/C+2C/D

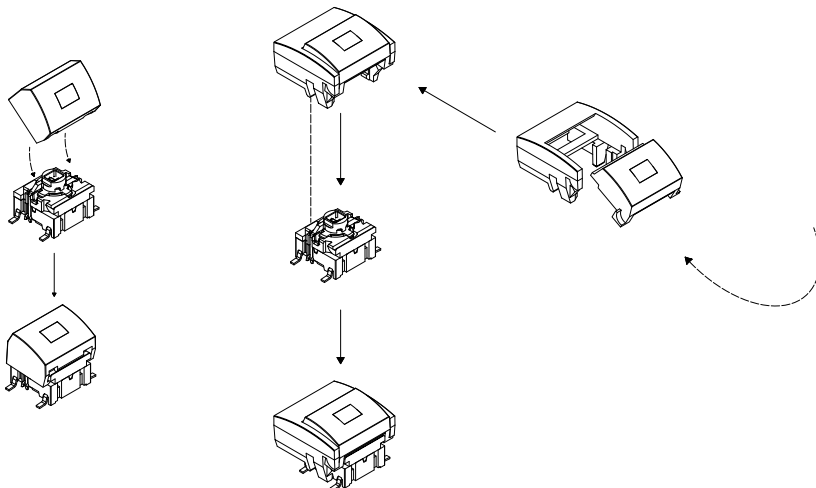

Operating force

(typical example)

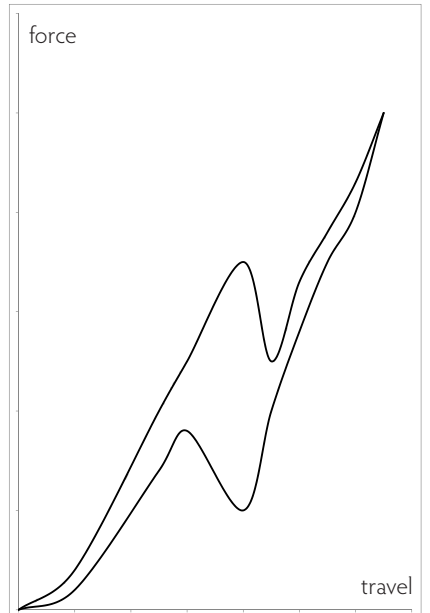

Mounting tool of multimec® through-hole switches

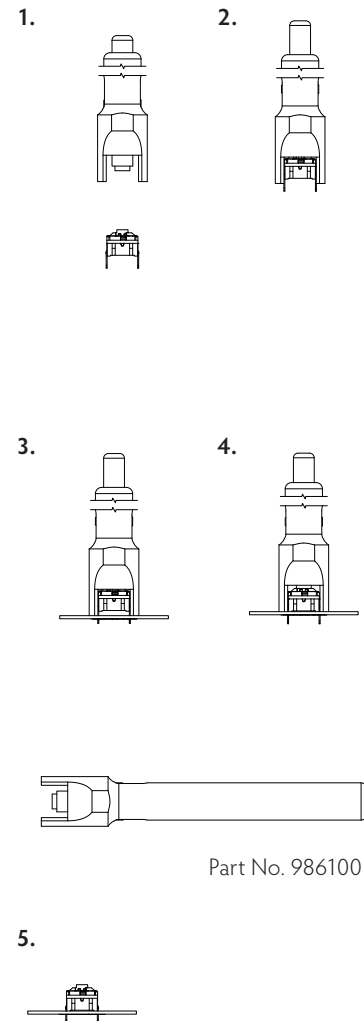

Basic switch spacing

through-hole (TH)

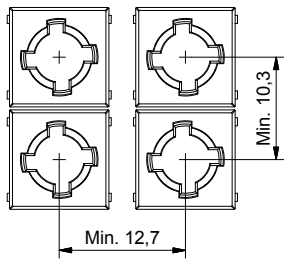

surface mount (SMD)

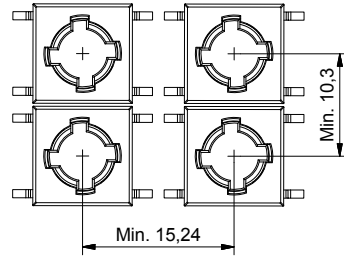

Recommended switch/cap spacing

Switch spacing

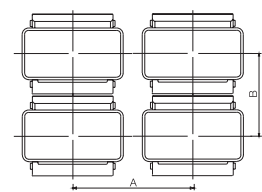

Cap dimension



Panel cut-out

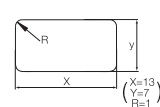

Panel cut-out

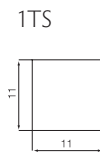
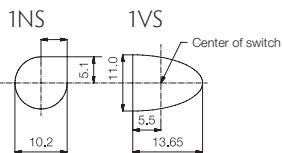

Spacing examples

multimec
5GT+1B/C+2C/D

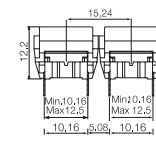

multimec
5GS+1B/C+2C/D

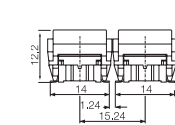

multimec
5GT + 1A/H

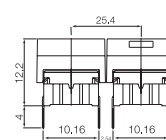

multimec
5GT + 1M

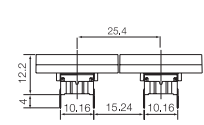

multimec
1NS + 1NS + 1NS

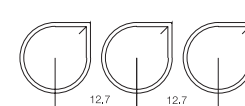

multimec
1VS + 1TS+ 1VS

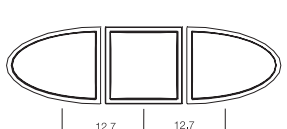

Cap series	Recommended * min. switch spacing AxB	Nominal cap dimension WxH	Recommended min. panel cut-out
1A/1H	12.7x10.16	12.6x10.1	13.0x10.5
1B/1C+2C/2D	15.24x15.24	15.1x15.1	15.5x15.5
1DS/1ES/1FS	12.7x12.7	ø9.6	ø10.0
1GAS	12.7x11.14	ø11	ø11.4
1GCS	15.14x15.14	ø15	ø15.4
1JS	12.7x12.7	ø9.6	ø10.4
1KS/1KBS/1KCS	15.24x15.24	14.3x14.3	14.7x14.7
1M	25.4x10.16	25.0x10.	25.7x10.5
1NS	12.7x12.7	ø9.8/□4.9	ø10.2/□5.1
1PS/1QS/1RS	15.24x10.16	6.5x12.5	7.0x13.0, R max. 1.0
1SS/1IS/1LS	12.7x12.7	ø6.5	ø7.0
1TS	12.7x12.7	10.6x10.6	11.0x11.0
1US	12.7x12.7	ø10.6	ø11.0
1VS	12.7x12.7	10.6x13.25	11.0x13.65
1WAS/1WPS	12.7x10.3	12.5x6.5	12.9x6.9
1WDS	15.34x10.3	15.2x8.0	15.6x8.4
1XS	12.7x12.7	9.4x7.4	9.8x7.9
1YS	17x17	15x15	16x16
1ZA	18.84x10.3	18.7x10.1	19.4x10.5
1ZB	24.34x12.1	R1=7.4; R2=17.5 90	R1=7.1; R2=17.5-17.75 90
1ZCS	14.44x14.44	ø14.3	ø14.7
1Z/1ZW	35.5x35.5; 41.6x41.6	ø29.5	ø30.3
10R	40.5x40.5	ø30.0	ø30.6
10Q	32.5x32.5	22x22	22.5x2.5

Circuit diagram for switches

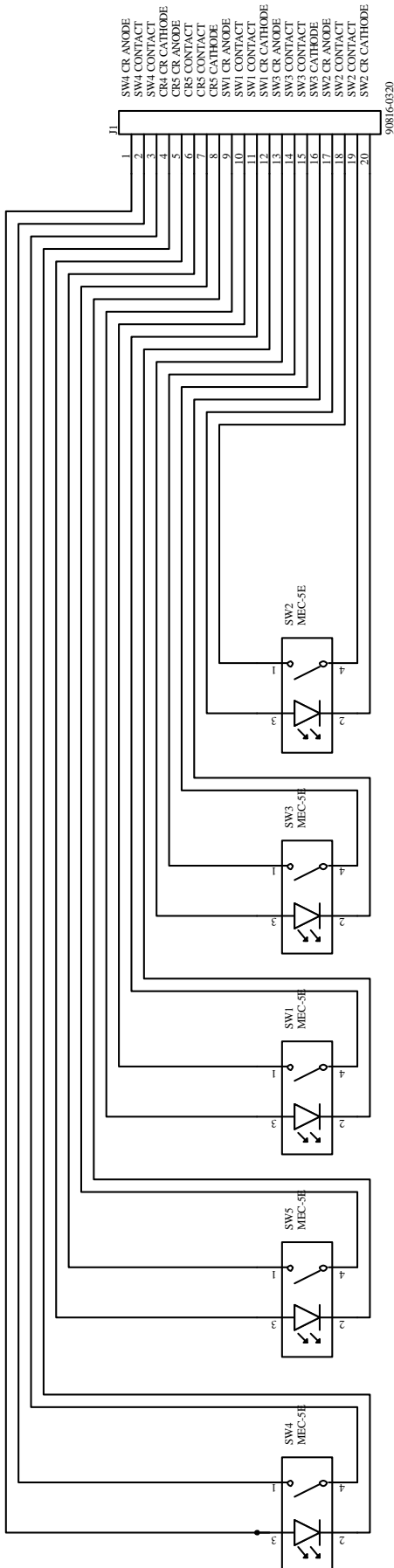

Circuit diagram for additional LEDs for controlmec™

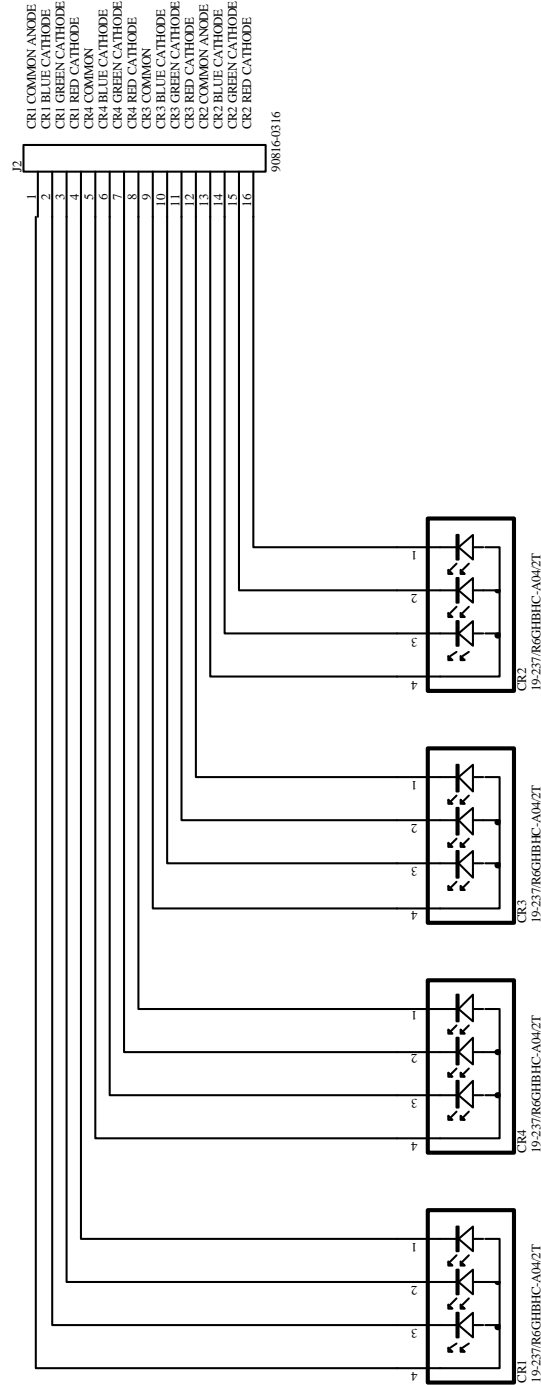

Connectors on the module are Molex picoflex series 90816-0320 for switches and 90816-0316 for additional LED.

We recommend using:

Cable socket: 90327-0320 for switches' and 90327-0316 for additional LEDs'

ERMEC, S.L. BARCELONA
C/ Francesc Teixidó, 22
E-08918 Badalona
(Spain)

Tel: (+34) 902 450 160
Fax: (+34) 902 433 088
info@ermec.com
www.ermec.com

ERMEC, S.L. MADRID
C/ Sagasta, 8, 1ª planta
E-28004 Madrid
(Spain)

PORTUGAL
portugal@ermec.com
BILBAO
bilbao@ermec.com

RoHS Compatible

	HIGH TEMPERATURE VERSIONS		
	SILVER	GOLD	NC/NO
ELECTRICAL SPECIFICATIONS			
Contact resistance	<30m Ω - typ. 10m Ω		
Insulation resistance	>10M Ω		
Recommended load	0.5-50mA 24VDC	0.5μ-50mA 24VDC	
Contact bounce	<2mS - typically 0.5mS		
MECHANICAL SPECIFICATIONS			
Standard actuation force (switch)	2.0N, 3.5N, 6.5 N		
Max. Actuation force without cap	100N for 10 sec		
Key travel (switch)	1 mm		
Life time (switch)	>10,000,000 cycles		>1,000,000 cycles
TEMPERATURE RANGE			
Working temperature	Min -40°C Max +160°C		
Storage temperature	Min -40°C Max +160°C		
5G with LED (working & storage temp)	Min -30°C Max +85°C		
Soldering (through-hole switch)	IEC 68-2-20 8:		
	Infrared, vapour phase, wave - max 240°C for max 40 sec or max 260°C for max 30 sec.		
	Soldering iron - max 350°C for max 3 sec.		
	Flux tight.		
SOLDERING (SMD)	JEDEC J-STD-020C		
ENVIRONMENTAL ENDURANCE IEC 68-2-3			
Temperature	+40°C		
Humidity	93% RH		
Duration	56 Days		
TEMPERATURE CYCLING IEC 68-2-14			
Temperature limit	Min -55°C - Max +85°C		
Number of cycles	200		
Exposure time at each temperature	10 min		
Recovery time before measurements	16 hrs		
Sealing IEC 529	IP-67		
Cleaning	Standard methods - see usage guidelines		
MATERIAL SPECIFICATIONS - SWITCHES			
Housing	PPS UL94VO		
Actuator	PPS UL94VO		
Sealing + spring	Silicone rubber		
Contact spring	Stainless steel	Stainless steel	
	+ 3μAg	1μAu	
Fixed contacts	SnCu + 2μNI + 3μAg	SnCu + 2μNI + 1μAu	
Terminals	SnCu + 2μNI + 3μSn100		

Caps & Bezels – Material Specifications

MATERIAL	PARTS	TEMP. LIMIT	UL RATING
ABS	1A, 1B, 1C, 1DS, 1ES, 1FS, 1H, 1JS, 1KS, 1LS, 1M, 1N, 1PS, 1QS, 1RS, 1TS, 1US, 1VS, 1WA, 1WD, 1WP, 1X, 1Z, 1ZA, 1ZB, 1ZCS, 1ZW, 2C, 2D, 2K, reflectors for 1KBS/1KCS and 1YS	Max. 65°C	UL94HB
Polycarbonate	All lenses and transparent colour caps, lids for 1KBS/1KCS	Max. 85°C	UL94V1
PPS	2S, 1GA/1GC	Max. 160°C	UL94VO
Polyamide	1SS	Max. 160°C	UL94VO
Legends Adhesion	ISO Class: 1/ASTM Class: 4B DIN EN ISO 2409		

RoHS Compatible

	LOW TEMPERATURE VERSIONS		HIGH TEMPERATURE VERSIONS	
	SILVER	GOLD	SILVER	GOLD
ELECTRICAL SPECIFICATIONS				
Contact resistance	<30m Ω - typ. 10m Ω		<30m Ω - typ. 10m Ω	
Insulation resistance	>10M Ω		>10M Ω	
Recommended load	0.5-50mA 24VDC	0.5μ-50mA 24VDC	0.5-50mA 24VDC	0.5μ-50mA 24VDC
Contact bounce	<2mS - typically 0.5mS		<2mS - typically 0.5mS	
MECHANICAL SPECIFICATIONS				
Standard actuation force (switch)	3.5N typ		3.5N typ	
Max. Actuation force without cap	100N for 10 sec		100N for 10 sec	
Key travel (switch)	1 mm		1 mm	
Life time (switch)	>10,000,000		>10,000,000	
Temperature Range				
Working temperature	Min -40°C Max +115°C		Min -40°C Max +160°C	
Storage temperature	Min -40°C Max +115°C		Min -40°C Max +160°C	
Soldering IEC 68-2-20	Wave - max 260°C for max 10 sec, please refer to usage guidelines. Soldering iron - max 350°C for max 3 sec. Flux tight.		Infrared, vapour phase, wave - max 240°C for max 40 sec or max 260°C for max 30 sec. Soldering iron - max 350°C for max 3 sec. Flux tight.	
ENVIRONMENTAL ENDURANCE IEC 68-2-3				
Temperature	+40°C		+40°C	
Humidity	93% RH		93% RH	
Duration	56 Days		56 Days	
TEMPERATURE CYCLING IEC 68-2-14				
Temperature limit	Min -55°C - Max +85°C		Min -55°C - Max +85°C	
Number of cycles	200		200	
Exposure time at each temperature	10 min		10 min	
Recovery time before measurements	16 hrs		16 hrs	
Sealing IEC 529	IP-67		IP-67	
Cleaning	Standard methods - see usage guidelines		Standard methods - see usage guidelines	
MATERIAL SPECIFICATIONS - SWITCHES				
Housing	PPS UL94VO		PPS UL94VO	
Actuator	PPS UL94VO		PPS UL94VO	
Sealing + spring	Silicone rubber		Silicone rubber	
Contact spring	Stainless steel	Stainless steel	Stainless steel	Stainless steel
	+ 3μAg	+ 1μAu	+ 3μAg	+ 1μAu
Fixed contacts	SnCu + 2μNI + 3μAg	SnCu + 2μNI + 1μAu	SnCu + 2μNI + 3μAg	SnCu + 2μNI + 1μAu
Terminals	SnCu + 2μNI + 3μSn100		SnCu + 2μNI + 3μSn100	

Caps – Material Specifications

MATERIAL	PARTS	TEMP. LIMIT	UL RATING
Polyamide	Actuators for varimec™	Max 160°C	UL94VO

LEDs specifications

Colour		Blue	Green	Yellow	White	Red
Colour Codes		01	22	42	61	82
ABSOLUTE MAXIMUM RATINGS (Ta=25°C)						
Power	mW	60	65	65	48	65
Current forward	mA	20	25	25	15	25
Forward peak current	mA	150	150	100	100	100
Voltage reverse	V	5	12	12	5	12
Operating temperature	°C	-30/+85				
Storage temperature	°C	-30/+85				
Soldering temperature	°C	245 for max. 10 sec				
ELECTRICAL-OPTICAL CHARACTERISTICS (Ta=25°C)						
Voltage forward	Typ. V	3.35	2.2	2	3.05	2
	Max. V	3.5	2.5	2.5	3.2	2.5
Current reverse (VR=5V)	µA	0.01	0.02	0.01	0.01	0.01
Wave length	nm	470	570	588	NA	633
Spread	Δnm	NA	30	16	NA	16
Spread angle	degree	145	160	160	150	160
Luminous Intensity	Min. mcd	30	28	112	71	112
	Typ. mcd	35	70	150	224*	150
Optical intensity	Lm/w	4	2.5			

*Max.mcd

For 3F switches

3FXXX (for 1E-1F-1N-1Q-1R-1S-1X)

3FXXX (for 1K-1T-1U-1V-1W-1WD)

Colour		B	G	Y	W	R	G/Y	R/G	R/Y	G	Y	R
Colour Codes		00	20	40	65	80	2040	8020	8040	24	45	87
Absolute Maximum Ratings	(Ta=25°C)											
Power	mW	105	70	60	120	60	120	100	120	60	130	120
Current forward	mA	30	20	20	25	20	25	30	25	25	40	50
Forward peak current	mA	200	60**	60**	100	60**	150	120	150	60	500	200
Voltage reverse	V	5	3	3	5	3	5	5	5	5	12	5
Operating temperature	°C	-25/+85			-40/+85	-25/+85	-40/+85	-55/+100	-40/+85	-40/+85	-55/+100	-40/+85
Storage temperature	°C	-30/+100			-40/+100	-30/+100	-40/+85	-55/+100	-40/+85	-40/+85	-55/+100	-40/+100
Soldering temperature	°C	260 for max 5 sec					260 for max 2 sec			300 for max 3 sec		260 for max 5 sec
Electrical-Optical Characteristics (Ta=25°C)												
Voltage forward	Typ. V	2.1	2.1	2.1	3.8	2.0	2.1	2.0	2.1	2.0*	2.3***	2.0***
	Max. V	2.8	3.0	3.0	4.3	3.0	2.8	2.6	2.8	2.4*	2.5***	2.4***
Current reverse (VR=5V)	µA	2	10	10	50	10	2	2	2	10	10	10
Wave length	nm	460	563	585	NA	650	565/590	630/565	625/590	570	587	624/632
Spread	Δnm	40	40	40	NA	40	35	35	35	10	45	20
Spread angle	degree	20	45	45	25	45	60	200	60	100	90	40
Luminous Intensity	Min. mcd	20	9.0	5.6	630	5.6	8	2.2	8	70****	71****	400****
	Typ. mcd	25	25	16	1000	16	25	4.8	25	20****	112****	800****
Orientation	The longer pin is the anode, the shorter is the cathode. For bicolour LEDs the anode for the first colour (ex. 2080) is the longer pin.											

Pulse width 1ms Duty cycle 1:5, */F =50mA, **** Luminous Flux mlm

B=Blue, G=Green, Y=Yellow, R=Red, W=White

Specifications are subject to change without notice.

ERMEC, S.L. BARCELONA
C/ Francesc Teixidó, 22
E-08918 Badalona
(Spain)

Tel.: (+34) 902 450 160
Fax: (+34) 902 433 088
info@ermec.com
www.ermec.com

ERMEC, S.L. MADRID
C/ Sagasta, 8, 1ª planta
E-28004 Madrid
(Spain)

PORTUGAL
portugal@ermec.com
BILBAO
bilbao@ermec.com

Specifications are subject to change without notice.

For product updates and/or changes of specifications please see www.mec.dk