

MicroSpeed® - 1.0 mm High Speed Mezzanine Connector System for 10 GBit/s

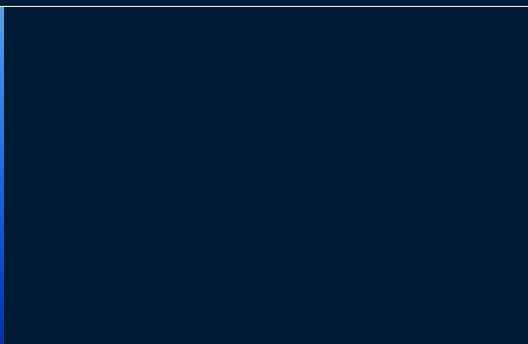

MicroSpeed® - 1.0 mm High Speed Mezzanine Connector System for 10 GBit/s

Table of Contents



General	2
Features	3
Mating Conditions	4
Board-to-Board Height Configurations	5
Layout Configuration	6
Electrical and Mechanical Characteristics	8
Packaging	10
2-Row Male Connectors	11
7-Row Male Connectors	15
2-Row Female Connectors	20
7-Row Female Connectors	24
Equipment and Testing	29
Part Number Index	30
Notes	31



ERMEC, S.L. BARCELONA
C/ Francesc Teixidó, 22
E-08918 Badalona
(Spain)

Tel.: (+34) 902 450 160
Fax: (+34) 902 433 088
info@ermec.com
www.ermec.com

ERMEC, S.L. MADRID
C/ Sagasta, 8, 1ª planta
E-28004 Madrid
(Spain)

PORTUGAL
portugal@ermec.com
BILBAO
bilbao@ermec.com

MicroSpeed® - 1.0 mm High Speed Mezzanine Connector System for 10 GBit/s

General

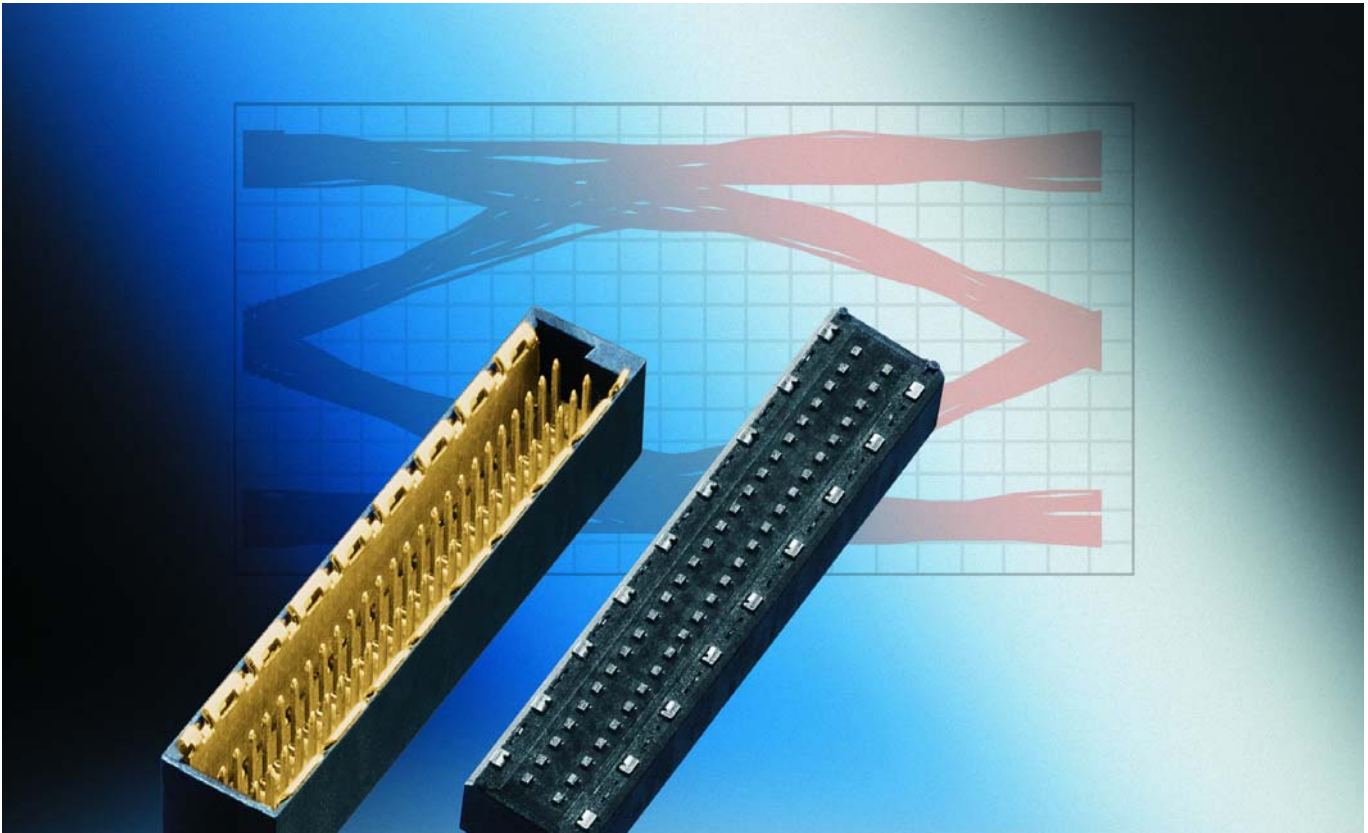

The MicroSpeed SMT connector for fast data transmission was designed especially for board-to-board connections in telecommunications and data-transmission devices. This modular connector system is the right solution for next-generation systems with transfer rates of up to 10 GBit/s. For differential data transmission several different signal pair arrangements are possible. Parallel signal connections are recommended for improved crosstalk properties. We achieve exceptional signal integrity by the design which features two signal and two shield contact rows. SPICE models are available. Evaluation boards also can be borrowed or purchased.

The MicroSpeed connector system permits signal transmissions with an impedance of 100 Ω (differential) or 50 Ω (single-ended). The termination area for signal contacts is in SMT and the termination area of the shield contacts is available as SMT or THR version. The connector is delivered in tape-and-reel packaging for the fully automatic SMT assembly. Providing a variety of height versions of the male (1, 2, 9 and 10 mm) and female (4, 6, 8 and 10 mm) connectors, the MicroSpeed connector system enables stacking heights from 5 mm to 20 mm. Subsequently, almost every need for different PCB arrangements can be addressed.

MicroSpeed® - 1.0 mm High Speed Mezzanine Connector System for 10 GBit/s

Features



Effective shielding design

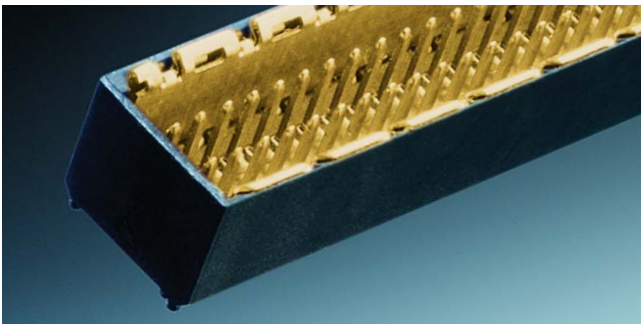

The MicroSpeed connector features a special shielding design with an optimized grid design for excellent RF characteristics and for easy and economical PCB footprint.

Optimized grid design

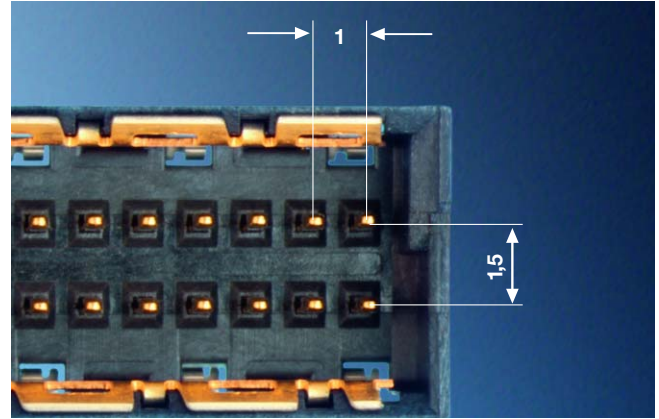

Eye diagrams for 10 GBit/s with 100 mm FR4 trace.

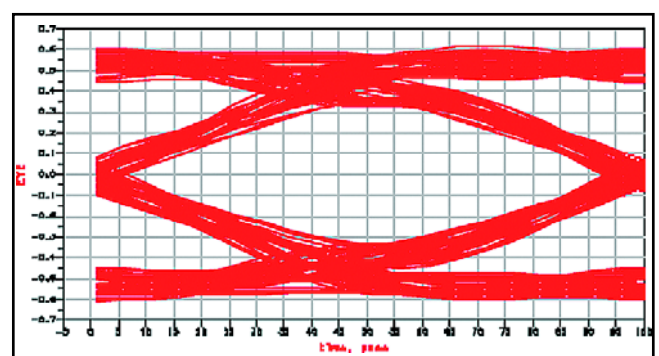
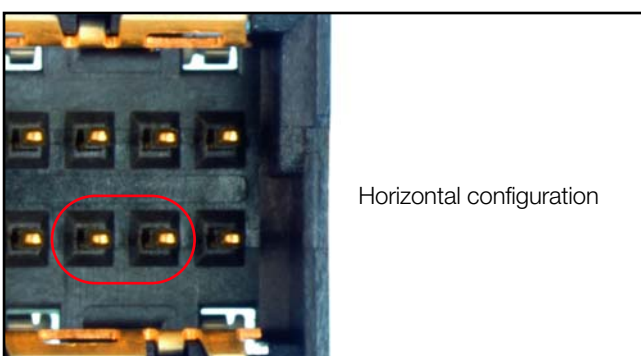
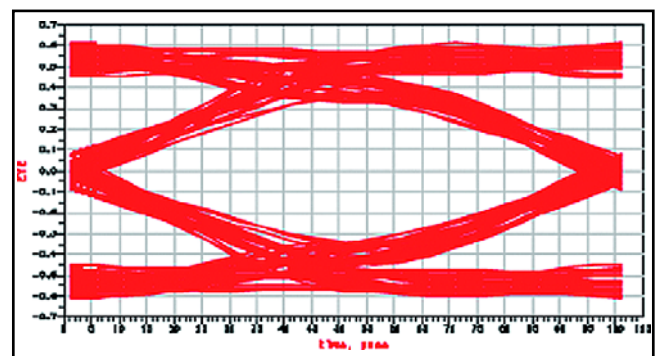
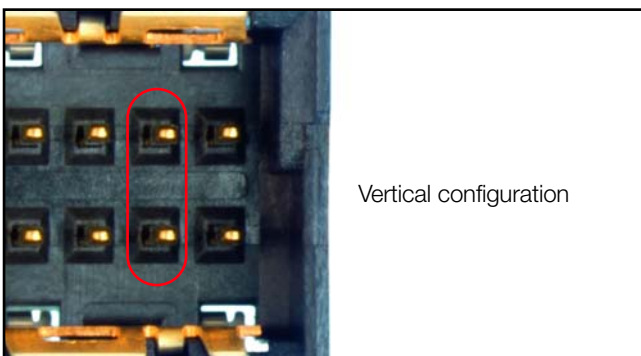



MicroSpeed® - 1.0 mm High Speed Mezzanine Connector System for 10 GBit/s

Mating Conditions*

Allowed misalignment tolerances in longitudinal and transverse axes ± 0.7 mm

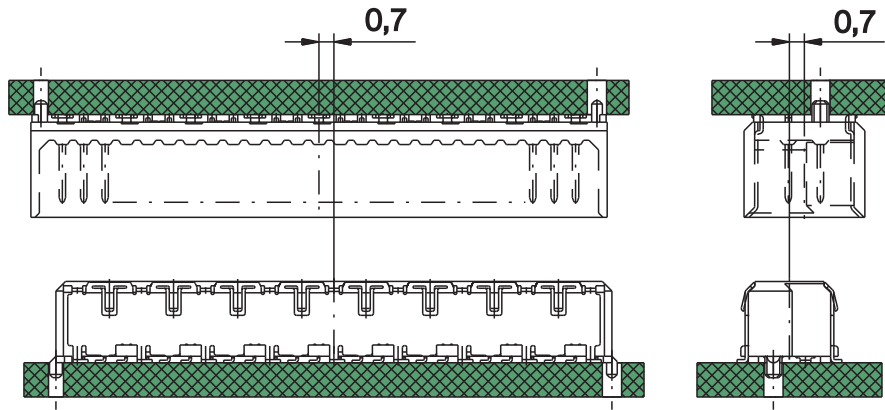

Allowed angular inclination tolerances longitudinal: $\pm 2^\circ$; transverse: $\pm 2^\circ$

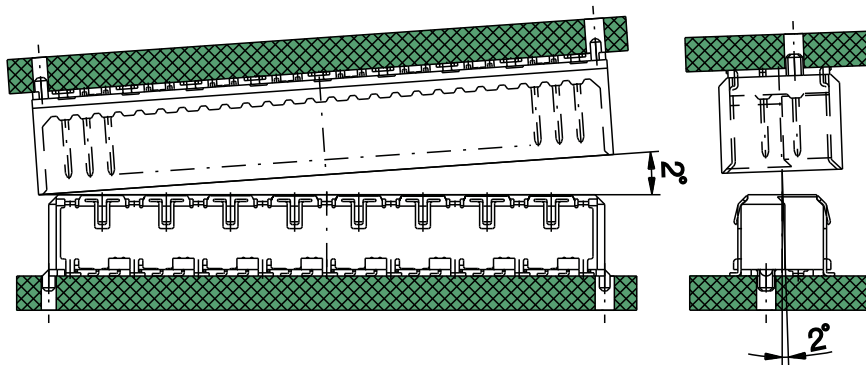

Wipe length - maximum "Board to Board" distance for secure mating: 1.5 mm

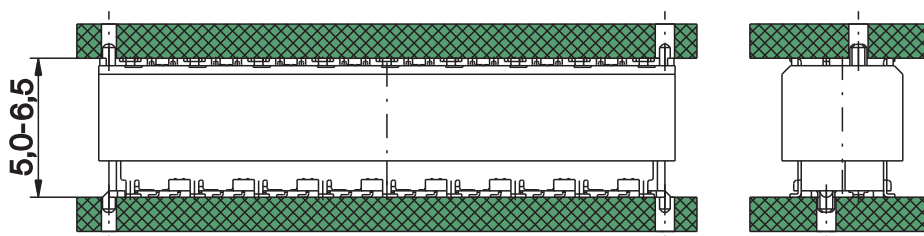



* The MicroSpeed connector has better misalignment tolerances as it is described in EIA-700AAAB standard.

All dimensions in mm

MicroSpeed® - 1.0 mm High Speed Mezzanine Connector System for 10 GBit/s

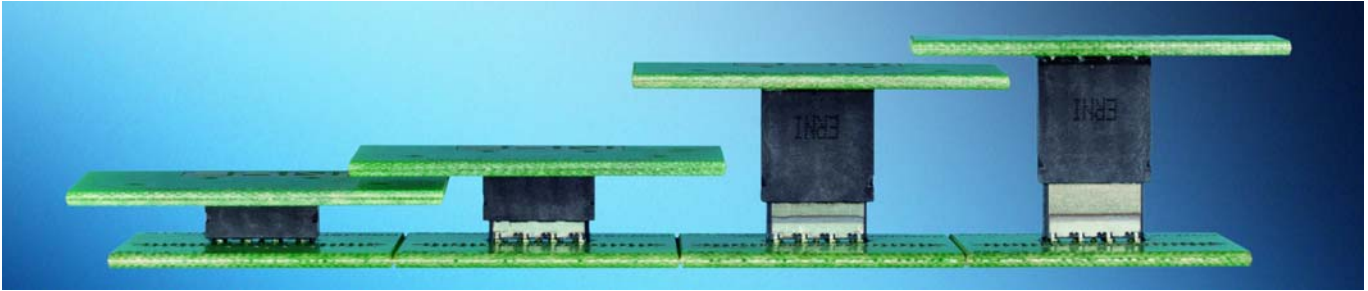
Board-to-Board Height Configurations

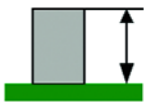

 Male			 Female			
Height	Partnumber SMD	Partnumber THR	Height	Partnumber SMD	Partnumber THR	Boart-to-Board Height
1 mm	144680	144681	4 mm	144662	144663	5 mm
2 mm	224557	224558	4 mm	144662	144663	6 mm
1 mm	144680	144681	6 mm	224512	224513	7 mm
2 mm	224557	224558	6 mm	224512	224513	8 mm
1 mm	144680	144681	8 mm	224514	224515	9 mm
2 mm	224557	224558	8 mm	224514	224515	10 mm
1 mm	144680	144681	10 mm	224516	224517	11 mm
2 mm	224557	224558	10 mm	224516	224517	12 mm
9 mm	224559	224560	4 mm	144662	144663	13 mm
10 mm	224561	224562	4 mm	144662	144663	14 mm
9 mm	224559	224560	6 mm	224512	224513	15 mm
10 mm	224561	224562	6 mm	224512	224513	16 mm
9 mm	224559	224560	8 mm	224514	224515	17 mm
10 mm	224561	224562	8 mm	224514	224515	18 mm
9 mm	224559	224560	10 mm	224516	224517	19 mm
10 mm	224561	224562	10 mm	224516	224517	20 mm

MicroSpeed® - 1.0 mm High Speed Mezzanine Connector System for 10 GBit/s

Layout Configuration



Layout example for 6 male connectors on one board

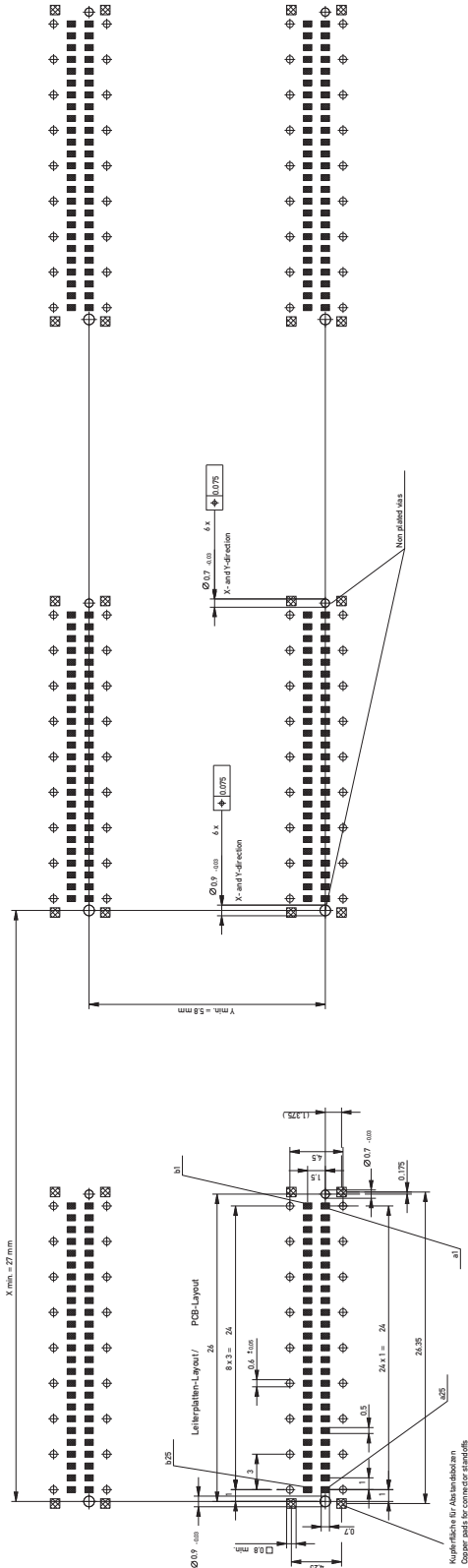

Layout example for 6 female connectors on one board

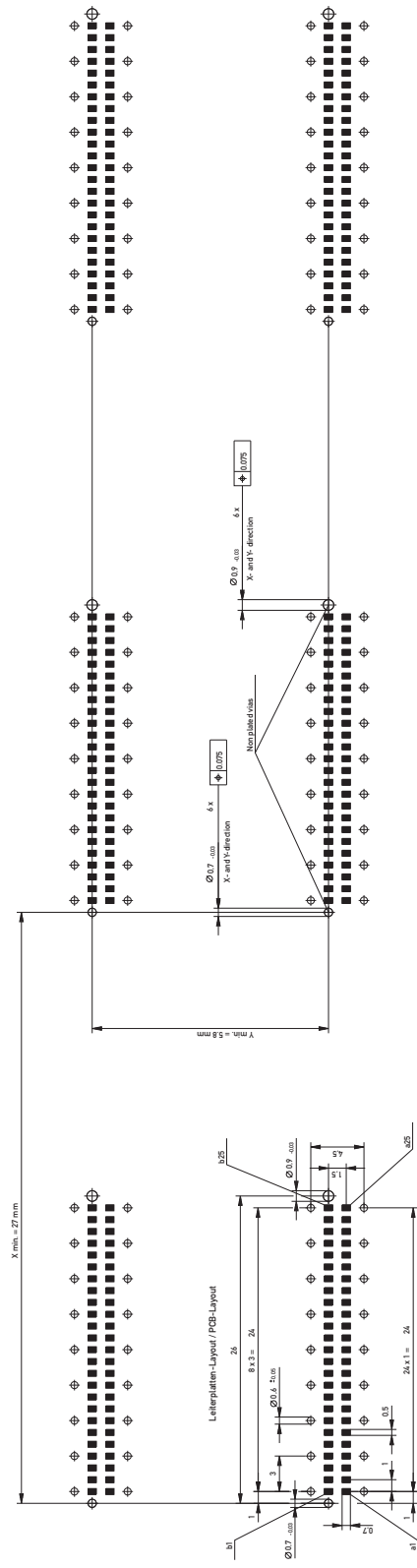

All dimensions in mm

MicroSpeed® - 1.0 mm High Speed Mezzanine Connector System for 10 GBit/s

Layout Configuration



Arrangement of Signal and Ground Contacts

(blue) - Ground contact
(yellow) - Signal contact

Single ended

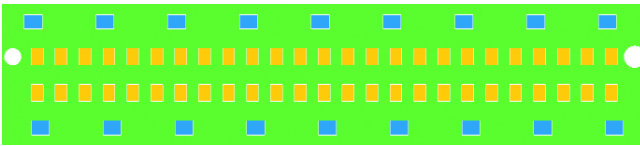

Single ended improved crosstalk

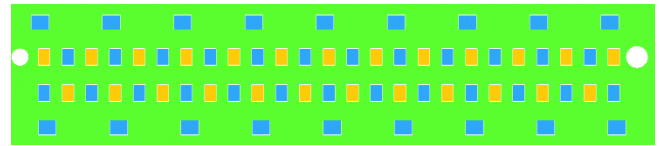

Differential horizontal improved crosstalk

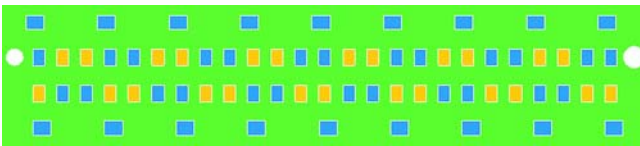

Differential vertical improved crosstalk

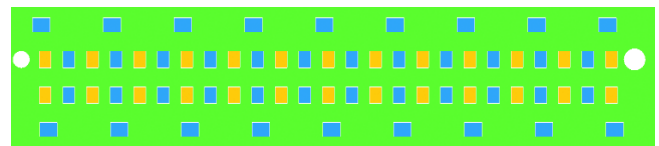



MicroSpeed® - 1.0 mm High Speed Mezzanine Connector System for 10 GBit/s

Electrical and Mechanical Characteristics

	Standard	Male and Female Connectors 2-row	Male and Female Connectors 7-row
Number of Pins		50	91, 133
Technical data			
Climate category	DIN EN 60068-1 test b	55/125/56	55/125/56
Temperature range		-55/125 °C	-55/125 °C
Current rating per contact		5 mm Board-to-Board height: 50pin 1.0 A @ 20 °C 0.8 A @ 70 °C 0.5 A @ 100 °C	5 mm Board-to-Board height: 91pin 133pin 1.0 A 0.9 A @ 20 °C 0.8 A 0.7 A @ 70 °C 0.5 A 0.4 A @ 100 °C
Air – and creepage distance		0.5 mm	0.5 mm
Operating voltage	IEC 60664	The permissible operating voltages depends on the customer application and on the applicable or specified safety requirements. Insulation coordination according to IEC 60664-1 has to be regarded for the complete electrical device. Therefore, the maximum creepage and clearance distances of the mated connectors are specified for consideration as a part of the whole current path. In practice, reductions in creepage or clearance distances may occur due to the conductive pattern of the printed board or the wiring used, and have to be taken into account separately. As a result the creepage and clearance distances for the application may be reduced compared to those of the connector.	
Dielectric strength	IEC 60512 test 4a	contact – contact 500 V _{rms} contact – ground 500 V _{rms}	contact – contact 500 V _{rms} contact – ground 500 V _{rms}
Contact resistance	IEC 60512 test 2a	< 25 mΩ	< 25 mΩ
Insulation resistance	IEC 60512 test 3a	> 10 ⁴ MΩ	> 10 ⁴ MΩ
Vibration, sine	IEC 60512 test 6d	10 – 2000 Hz 20g	10 – 2000 Hz 20g
Contact disturbance (while vibration test)	IEC 60512 test 2e	< 1 μs	< 1 μs
Shock, halfsine	IEC 60512 test 6c	50 g 11 ms	50 g 11 ms
Contact disturbance (while shock test)	IEC 60512 test 2e	< 1 μs	< 1 μs
Mechanical operation (mating cycles)	IEC 60512 test 9a	> 500 mating cycles	> 500 mating cycles
Insertion and withdrawal force	IEC 60512 test 13b	max. 0.5 N/pin	max. 0.5 N/pin
Gauge retention force	IEC 60512 test 16e	> 0.1 N	> 0.1 N



MicroSpeed® - 1.0 mm High Speed Mezzanine Connector System for 10 GBit/s

Electrical and Mechanical Characteristics

Standard	Male and Female Connectors 2-row	Male and Female Connectors 7-row
Number of Pins	50	91, 133
Signal transmission data		
Multiline crosstalk	< 2% at 100 ps	< 2% at 100 ps
Differential impedance	100 Ω	100 Ω
Single ended impedance	50 Ω	50 Ω
Process-conditions		
Soldering temperature max.	IEC 68-2-20	
Hand soldering temperature max.	3.5 s at 350 °C	3.5 s at 350 °C
Dip soldering temperature max.	10 s at 260 °C	10 s at 260 °C
Reflow soldering temperature max.	JEDEC J-STD-020C 20 - 40 s at 260 °C	20 - 40 s at 260 °C
Coplanarity	< 0.1 mm	< 0.1 mm
Housing materials		
Plastic material	LCP	LCP
CTI value	175	175
UL flame rating	UL 94 V-0	UL 94 V-0
UL file	E 83005	E 83005
Contact materials		
Base material	Cu alloy	Cu alloy
Mating area	min. 1.0 µm PdNi + 0.1 µm Au over 1-2 µm Ni	min. 1.0 µm PdNi + 0.1 µm Au over 1-2 µm Ni
Termination area	4-6 µm Sn over 1-2 µm Ni	4-6 µm Sn over 1-2 µm Ni
Environment compatibility		
Recycling	no flame-retardent additives, no toxic additives allows easy recycling	

MicroSpeed® - 1.0 mm High Speed Mezzanine Connector System for 10 GBit/s

Packaging



Packaging Dimensions

2-row 50pin Male and Female Connectors

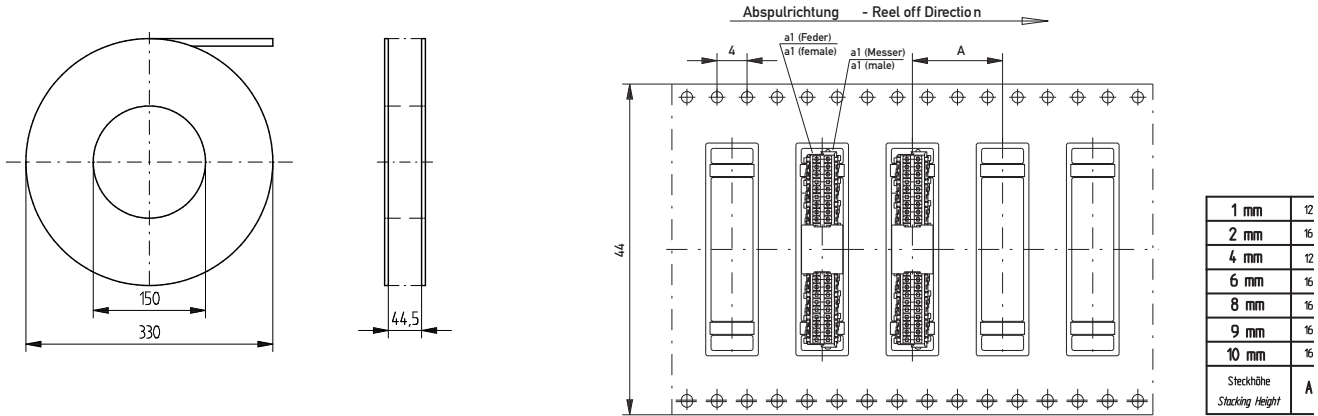

7-row 91pin Male and Female Connectors

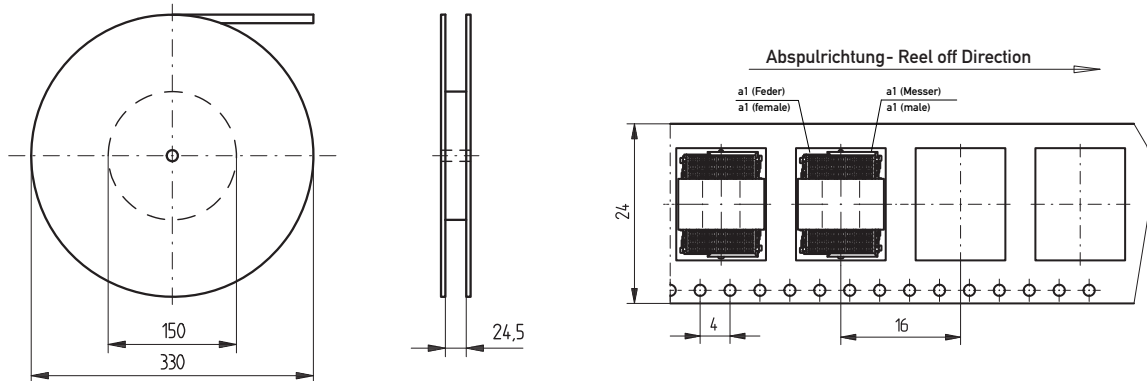

7-row 133pin Male and Female Connectors

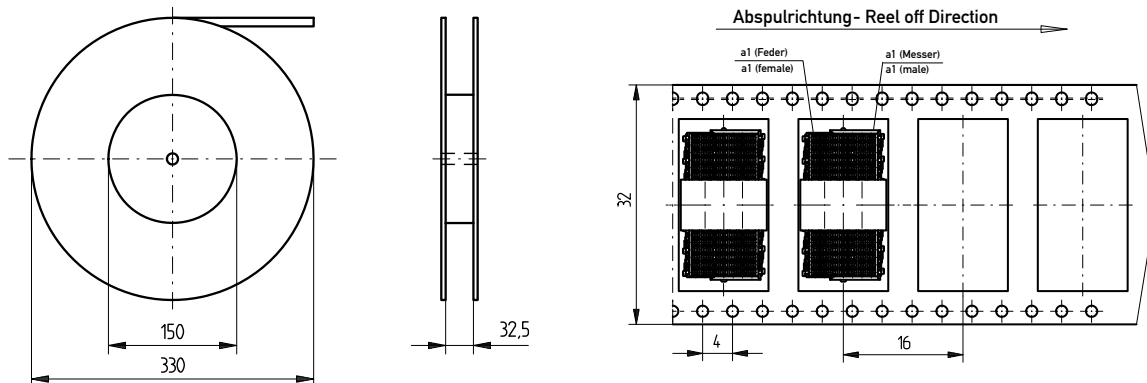



MicroSpeed® - 1.0 mm High Speed Mezzanine Connector System for 10 GBit/s

2-Row Male Connectors

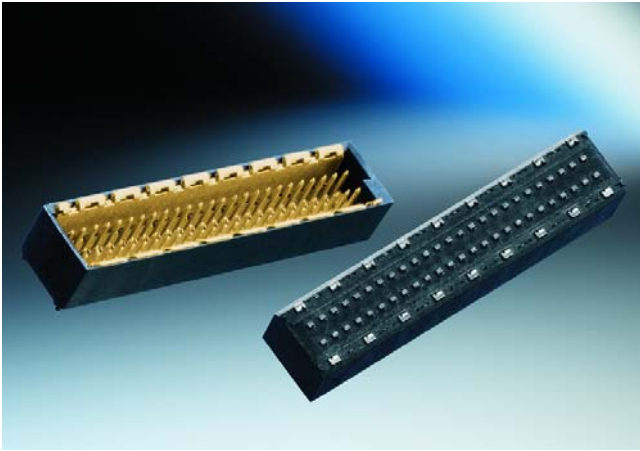

- Data rates up to 10 GBit/s
- 100 Ω impedance for differential signal transmission
- 50 Ω impedance for single ended signal transmission
- For improved crosstalk parallel signal ports are recommended (see catalog page 7)
- Shield contacts available as SMT or THR version
- Tape and reel packaging
- Black high-temperature insulator for fast and reliable visual recognition
- Integral pick and place surface for easy grip with a vacuum nozzle.

Dimensional Drawings

Connectors with SMT Ground Pins

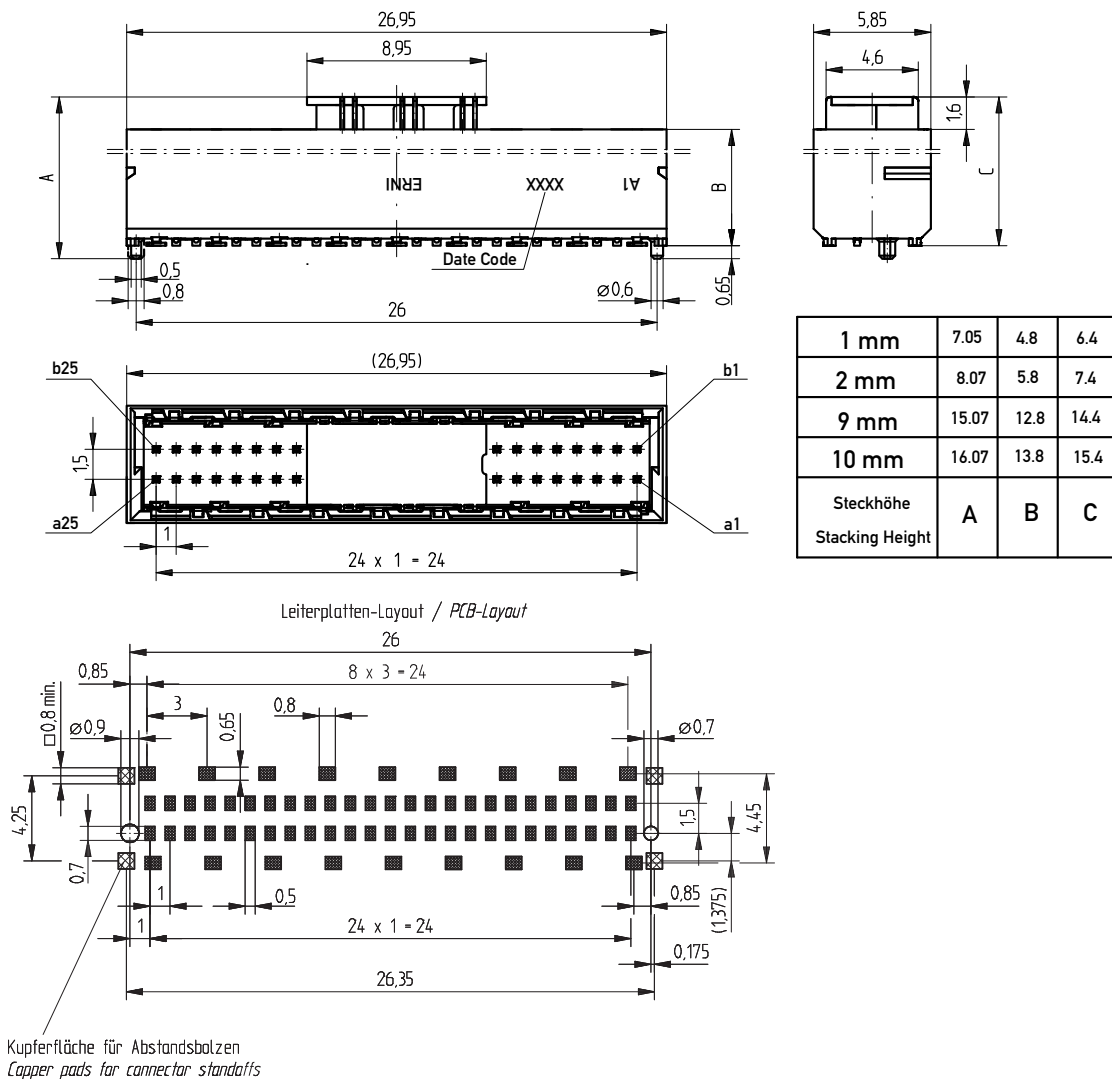

All dimensions in mm

MicroSpeed® - 1.0 mm High Speed Mezzanine Connector System for 10 GBit/s

2-Row Male Connectors



Dimensional Drawings

Connectors with THR Ground Pins

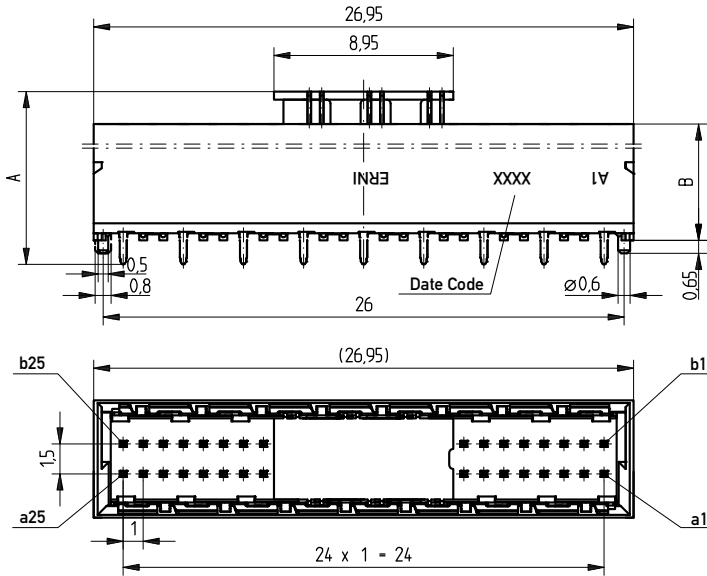

1 mm	7.6	4.8	6.4
2 mm	8.6	5.8	7.4
9 mm	15.6	12.8	14.4
10 mm	16.6	13.8	15.4
Steckhöhe Stacking Height	A	B	C

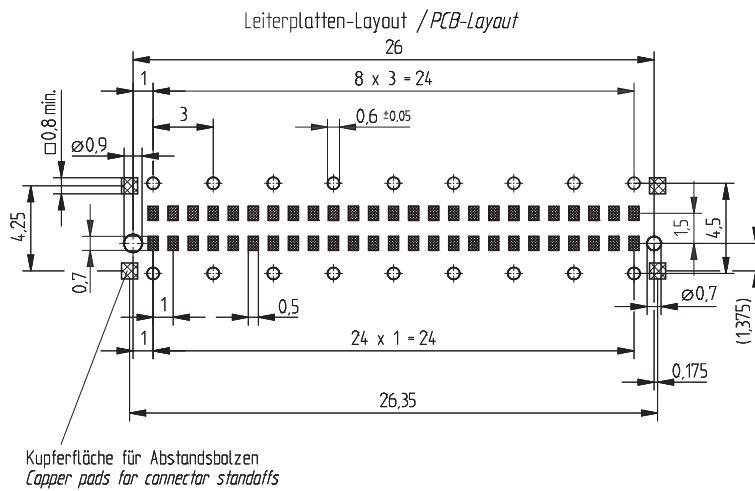

All dimensions in mm



MicroSpeed® - 1.0 mm High Speed Mezzanine Connector System for 10 GBit/s 2-Row Male Connectors

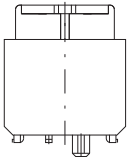
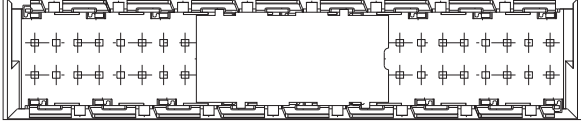
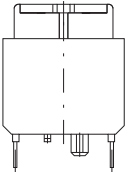
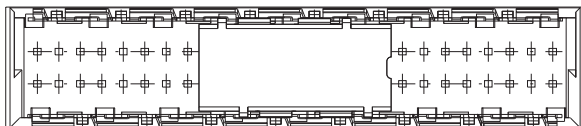
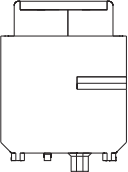
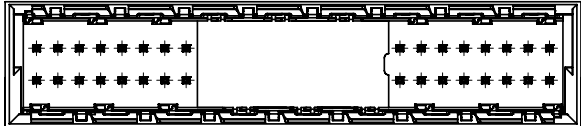
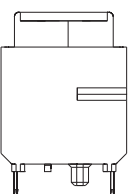
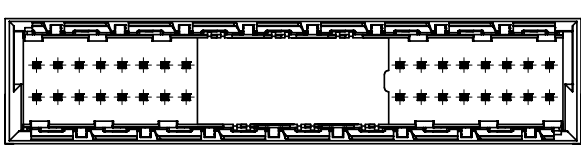

Configuration	Number of Pins	Termination	Unmated Stacking Height	Part Number
	50	SMT	1 mm	144680
				
Male connector, tape and reel, 400 pcs/reel				
	50	SMT/THR	1 mm	144681
				
Male connector, tape and reel, 400 pcs/reel				
	50	SMT	2 mm	224557
				
Male connector, tape and reel, 400 pcs/reel				
	50	SMT/THR	2 mm	224558
				
Male connector, tape and reel, 400 pcs/reel				

MicroSpeed® - 1.0 mm High Speed Mezzanine Connector System for 10 GBit/s 2-Row Male Connectors

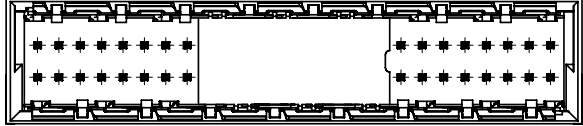
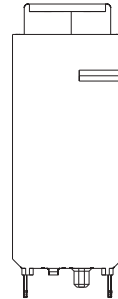
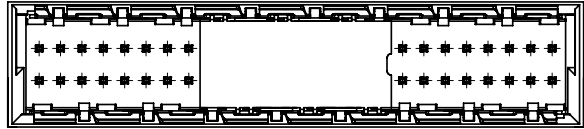
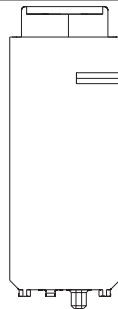
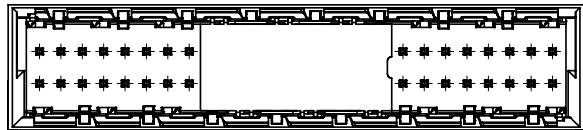

Configuration	Number of Pins	Termination	Unmated Stacking Height	Part Number
 	50	SMT	9 mm	224559
Male connector, tape and reel, 220 pcs/reel				
 	50	SMT/THR	9 mm	224560
Male connector, tape and reel, 220 pcs/reel				
 	50	SMT	10 mm	224561
Male connector, tape and reel, 220 pcs/reel				
 	50	SMT/THR	10 mm	224562
Male connector, tape and reel, 220 pcs/reel				

MicroSpeed® - 1.0 mm High Speed Mezzanine Connector System for 10 GBit/s

7-Row Male Connectors

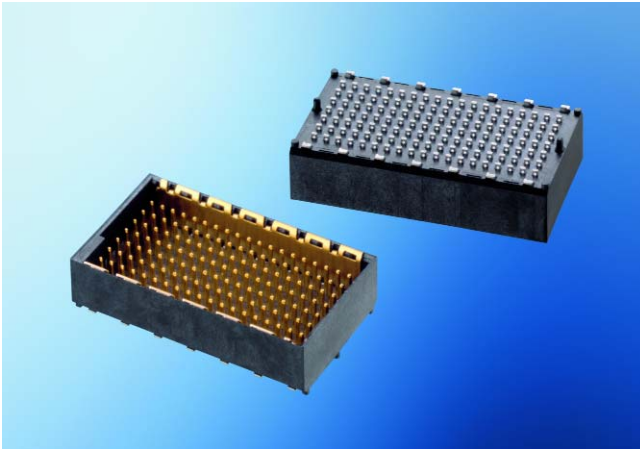

- Data rates up to 10 GBit/s
- 100 Ω impedance for differential signal transmission
- 50 Ω impedance for single ended signal transmission
- Shield contacts available as SMT or THR version
- Tape and reel packaging
- Black high-temperature insulator for fast and reliable visual recognition
- Integral pick and place surface for easy grip with a vacuum nozzle

Dimensional Drawings

91 Pin Connector with SMT Ground Pins

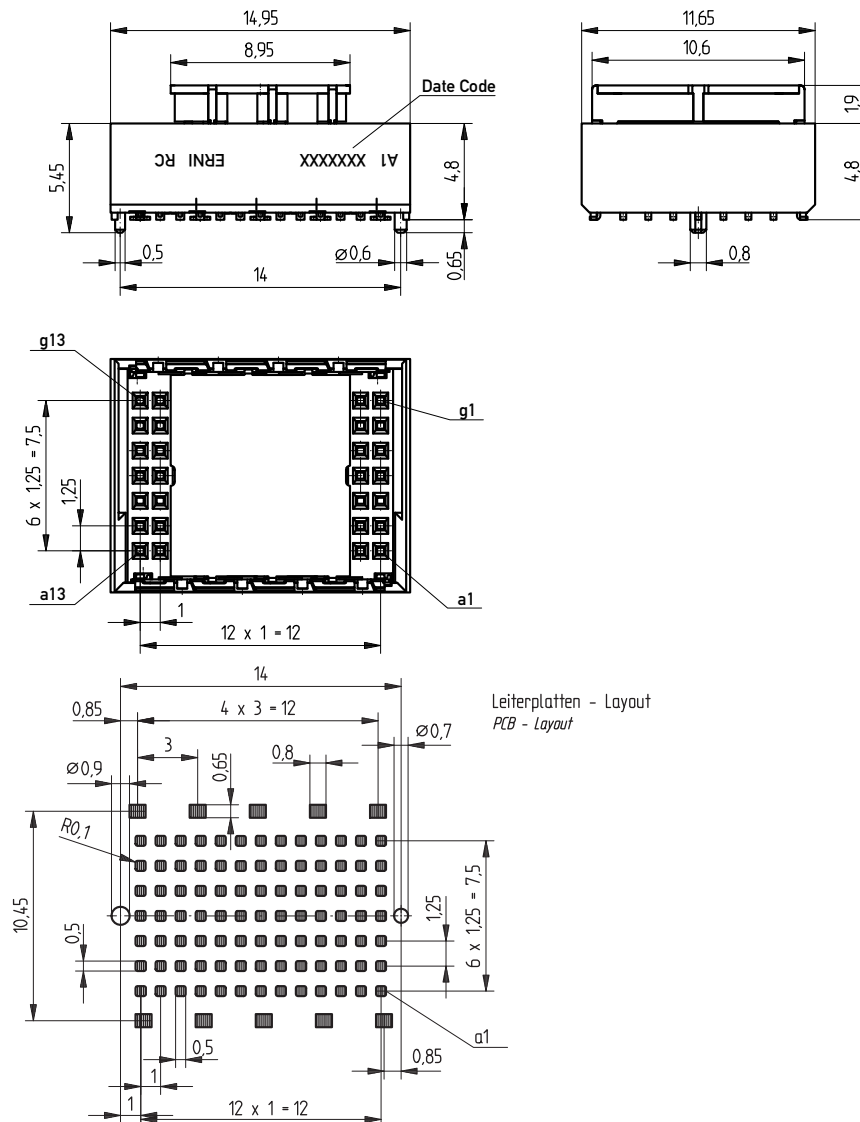

All dimensions in mm

MicroSpeed® - 1.0 mm High Speed Mezzanine Connector System for 10 GBit/s

7-Row Male Connectors



Dimensional Drawings

91 Pin Connector with THR Ground Pins

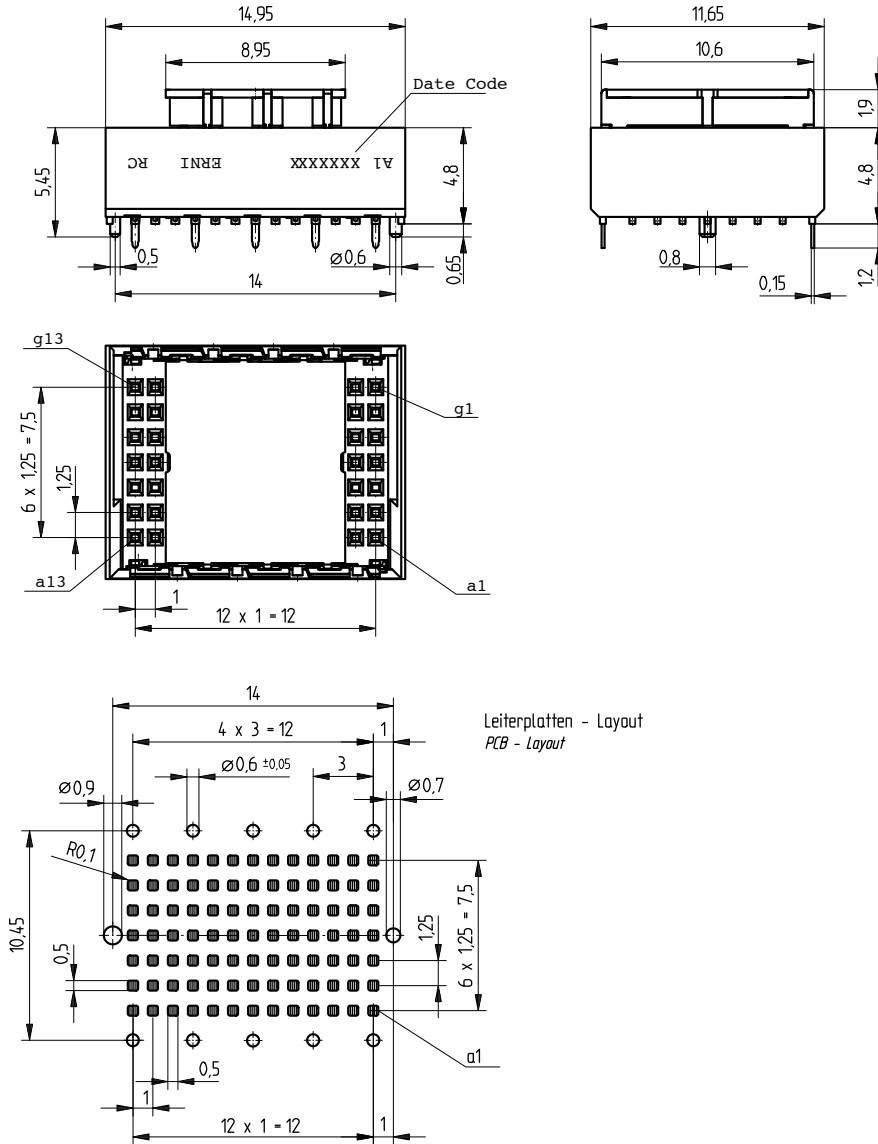

All dimensions in mm



MicroSpeed® - 1.0 mm High Speed Mezzanine Connector System for 10 GBit/s

7-Row Male Connectors

Dimensional Drawings

133 Pin Connector with SMT Ground Pins

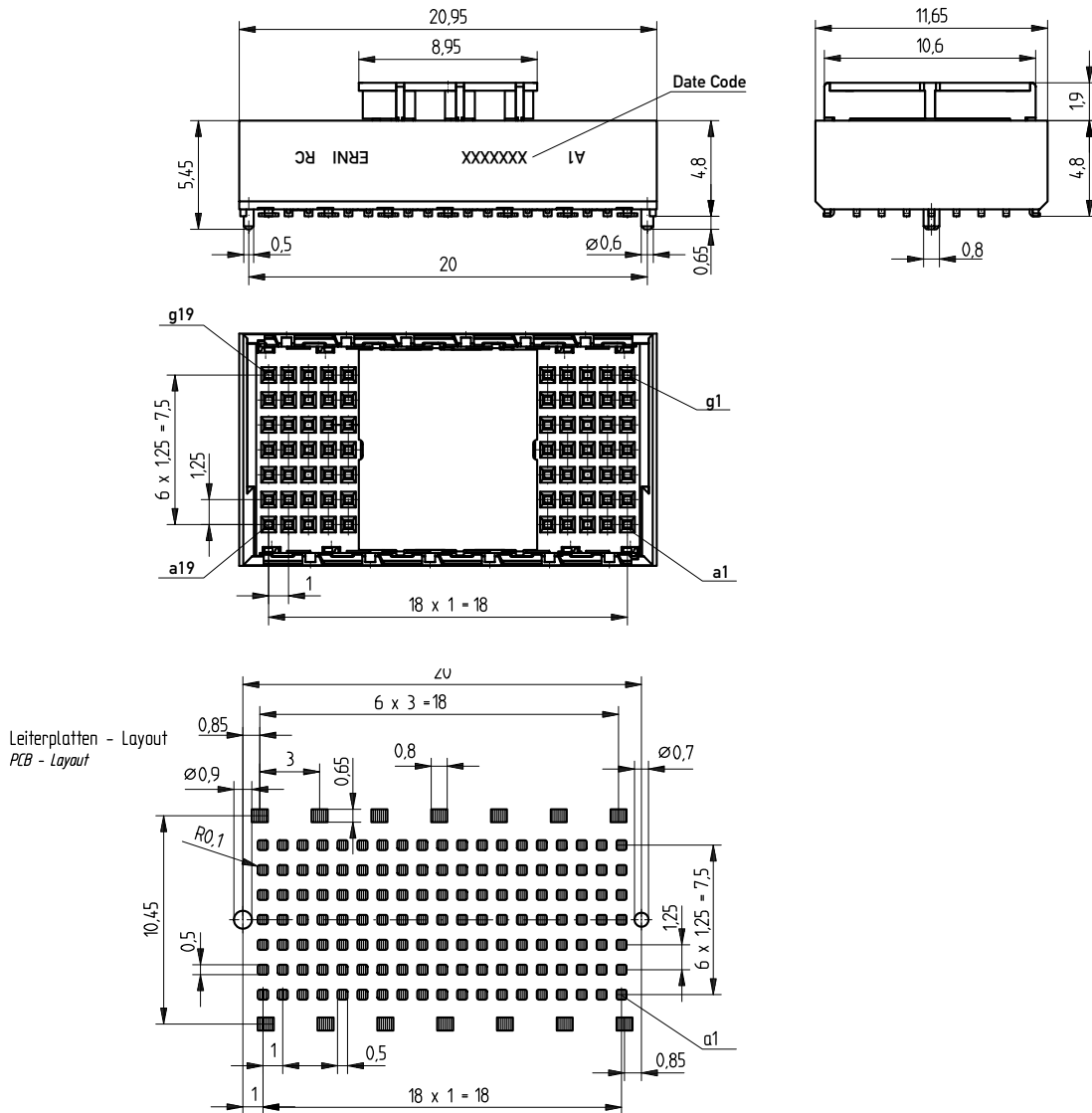

All dimensions in mm



MicroSpeed® - 1.0 mm High Speed Mezzanine Connector System for 10 GBit/s

7-Row Male Connectors

Dimensional Drawings

133 Pin Connector with THR Ground Pins

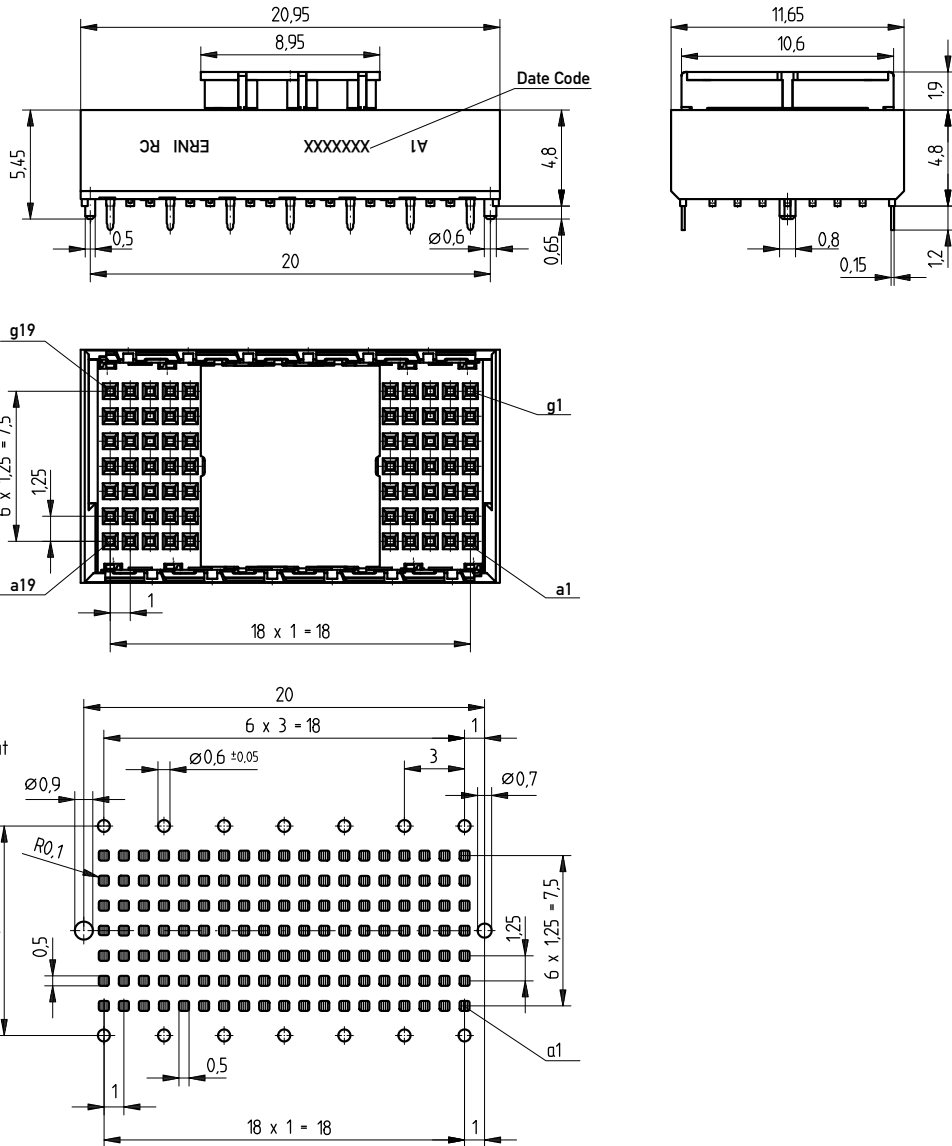

All dimensions in mm



MicroSpeed® - 1.0 mm High Speed Mezzanine Connector System for 10 GBit/s

7-Row Male Connectors

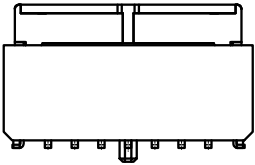
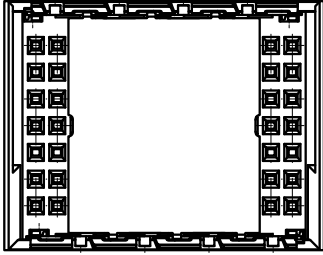
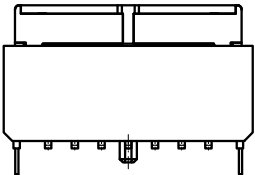
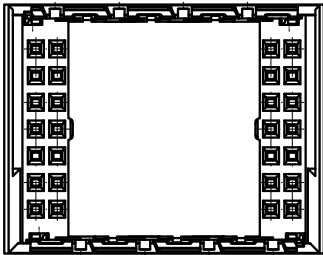
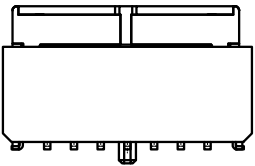
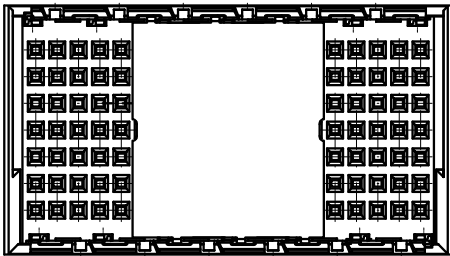
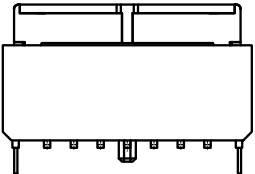
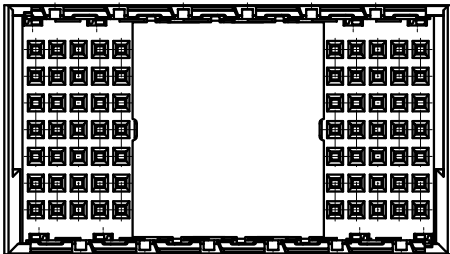
Configuration	Number of Pins	Termination	Unmated Stacking Height	Part Number
	91	SMT	1 mm	224212
				
Male connector, tape and reel 440 pcs/reel				
	91	SMT/THR	1 mm	234752
				
Male connector, tape and reel 440 pcs/reel				
	133	SMT	1 mm	214355
				
Male connector, tape and reel 440 pcs/reel				
	133	SMT/THR	1 mm	234753
				
Male connector, tape and reel 440 pcs/reel				



MicroSpeed® - 1.0 mm High Speed Mezzanine Connector System for 10 GBit/s

2-Row Female Connectors

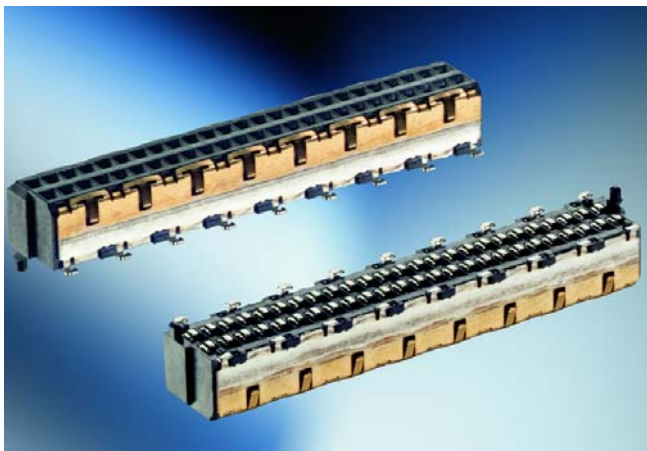

- Data rates up to 10 GBit/s
- 100 Ω impedance for differential signal transmission
- 50 Ω impedance for single ended signal transmission
- For improved crosstalk parallel signal ports are recommended (see catalog page 7)
- Shield contacts available as SMT or THR version
- Tape and reel packaging
- Black high-temperature insulator for fast and reliable visual recognition
- Integral pick and place surface for easy grip with a vacuum nozzle.

Dimensional Drawings

Connectors with SMT Ground Pins

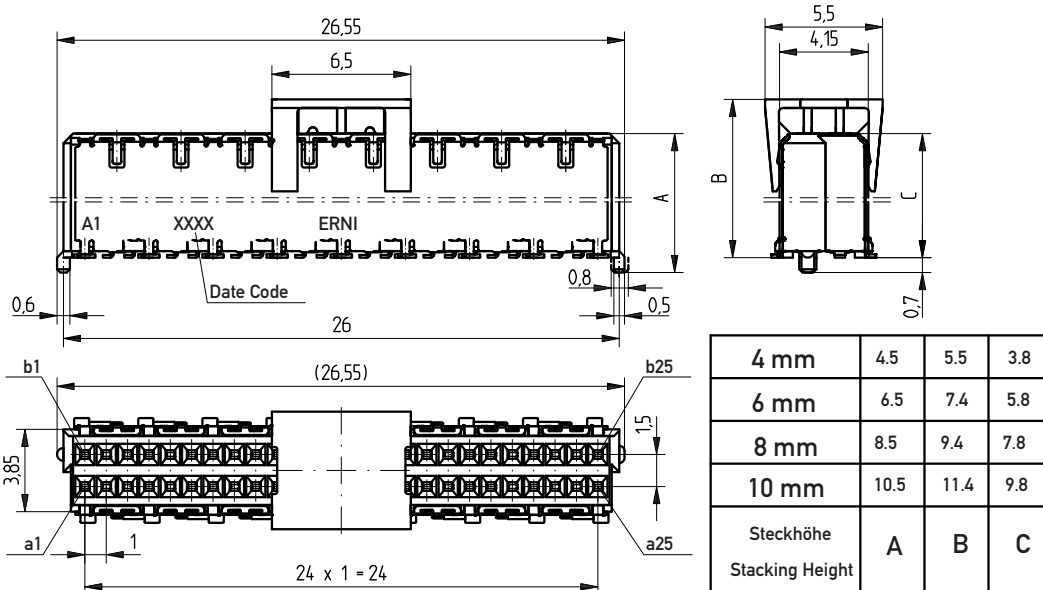

Leiterplatten-Layout / PCB-Layout

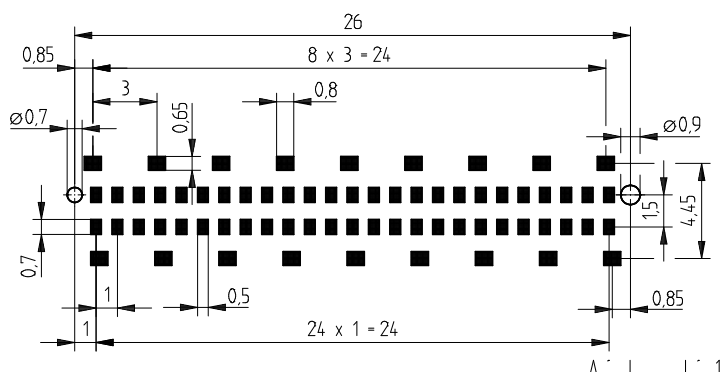

All dimensions in mm

MicroSpeed® - 1.0 mm High Speed Mezzanine Connector System for 10 GBit/s

2-Row Female Connectors



Dimensional Drawings

Connectors with THR Ground Pins

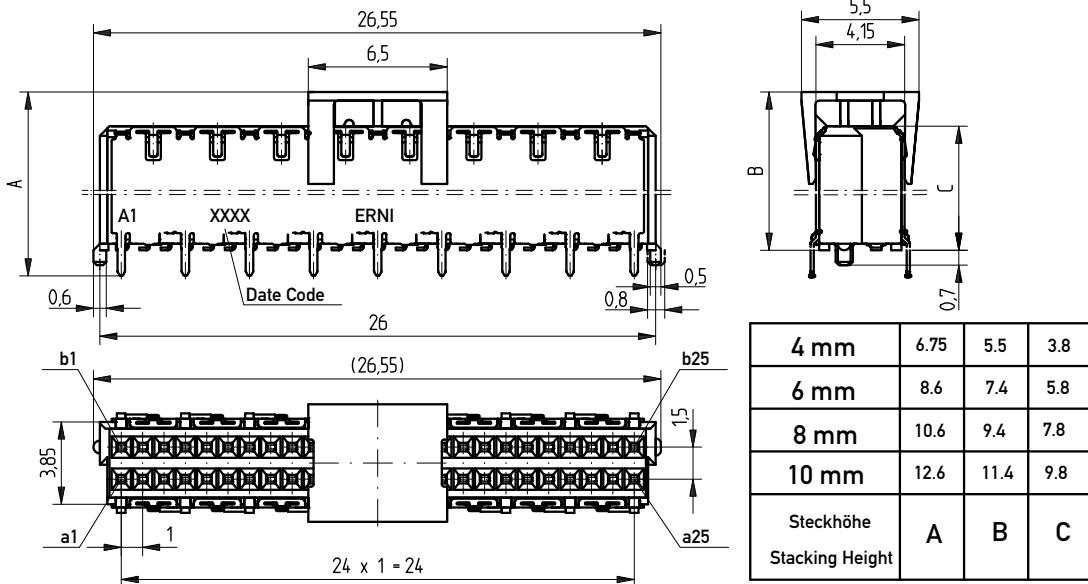

Leiterplatten-Layout / PCB-Layout

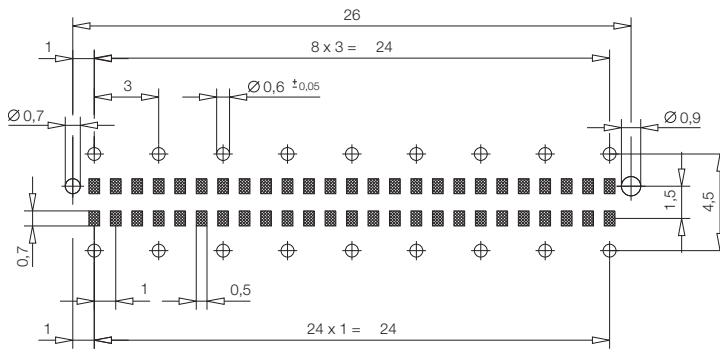





All dimensions in mm

MicroSpeed® - 1.0 mm High Speed Mezzanine Connector System for 10 GBit/s

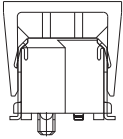
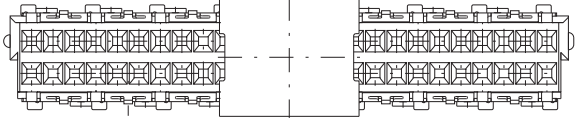
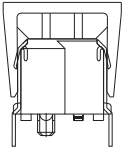
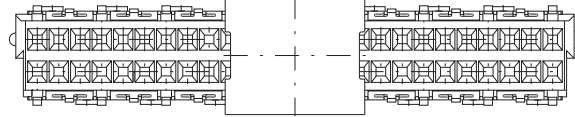
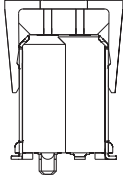
2-Row Female Connector

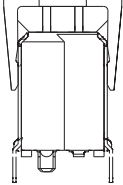

Configuration	Number of Pins	Termination	Unmated Stacking Height	Part Number
				
Female connector, tape and reel, 400 pcs/reel	50	SMT	4 mm	144662
				
Female connector, tape and reel, 400 pcs/reel	50	SMT/THR	4 mm	144663
				
Female connector, tape and reel, 400 pcs/reel	50	SMT	6 mm	224512
				
Female connector, tape and reel, 400 pcs/reel	50	SMT/THR	6 mm	224513

MicroSpeed® - 1.0 mm High Speed Mezzanine Connector System for 10 GBit/s 2-Row Female Connectors

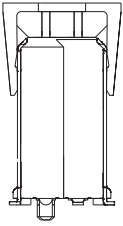
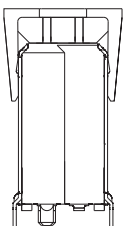
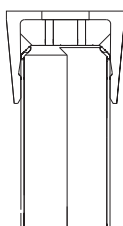
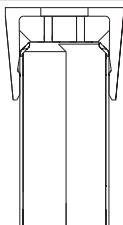

Configuration	Number of Pins	Termination	Unmated Stacking Height	Part Number
	50	SMT	8 mm	224514
Female connector, tape and reel, 260 pcs/reel				
	50	SMT/THR	8 mm	224515
Female connector, tape and reel, 260 pcs/reel				
	50	SMT	10 mm	224516
Female connector, tape and reel, 260 pcs/reel				
	50	SMT/THR	10 mm	224517
Female connector, tape and reel, 260 pcs/reel				

MicroSpeed® - 1.0 mm High Speed Mezzanine Connector System for 10 GBit/s

7-Row Female Connectors

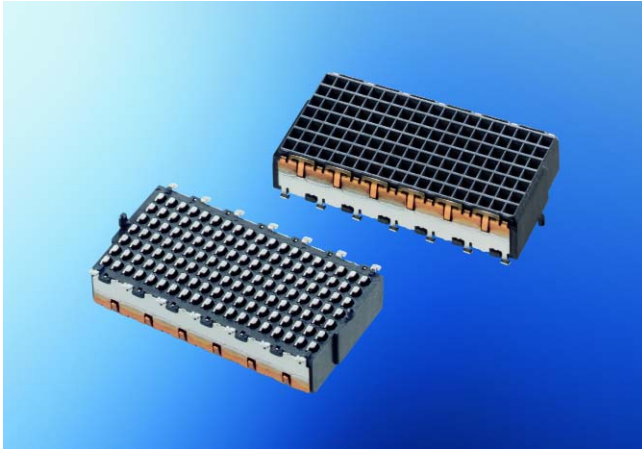

- Data rates up to 10 GBit/s
- 100 Ω impedance for differential signal transmission
- 50 Ω impedance for single ended signal transmission
- Shield contacts available as SMT or THR version
- Tape and reel packaging
- Black high-temperature insulator for fast and reliable visual recognition
- Integral pick and place surface for easy grip with a vacuum nozzle

Dimensional Drawings

91 Pin Connector with SMT Ground Pins

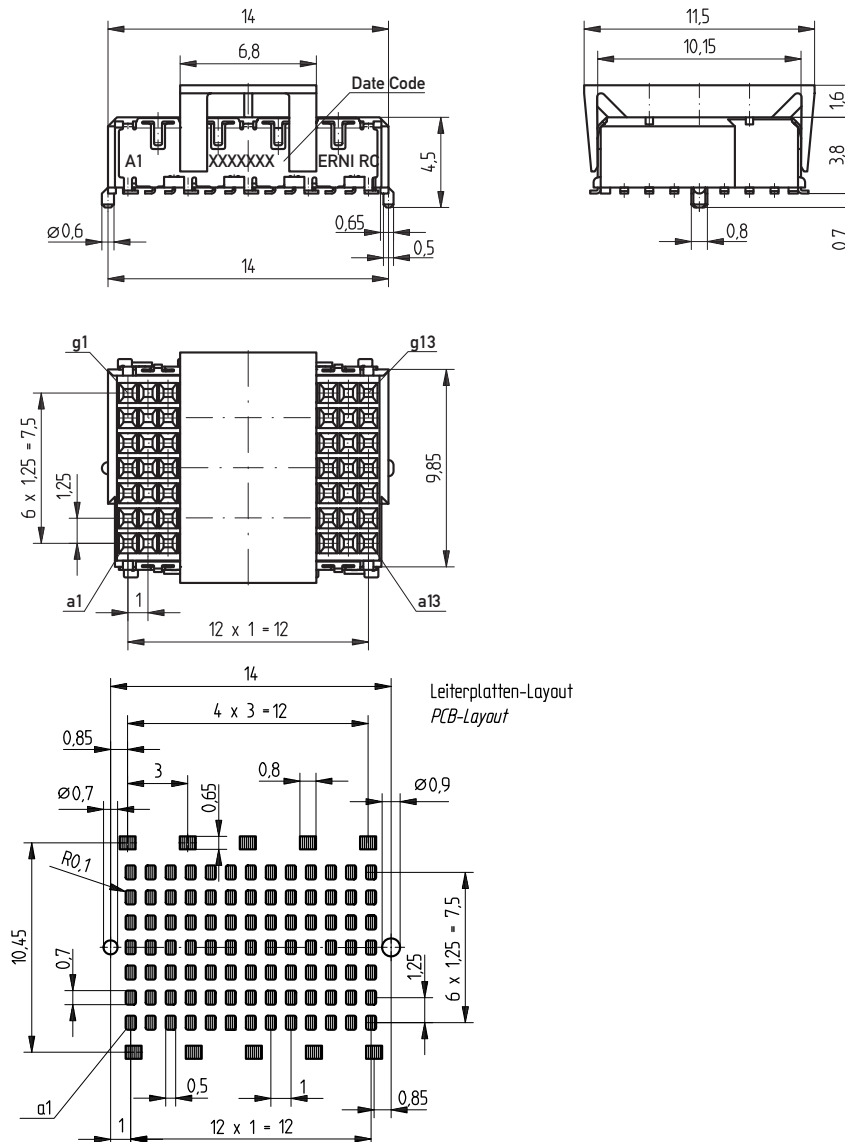

All dimensions in mm



MicroSpeed® - 1.0 mm High Speed Mezzanine Connector System for 10 GBit/s

7-Row Female Connectors

Dimensional Drawings

91 Pin Connector with THR Ground Pins

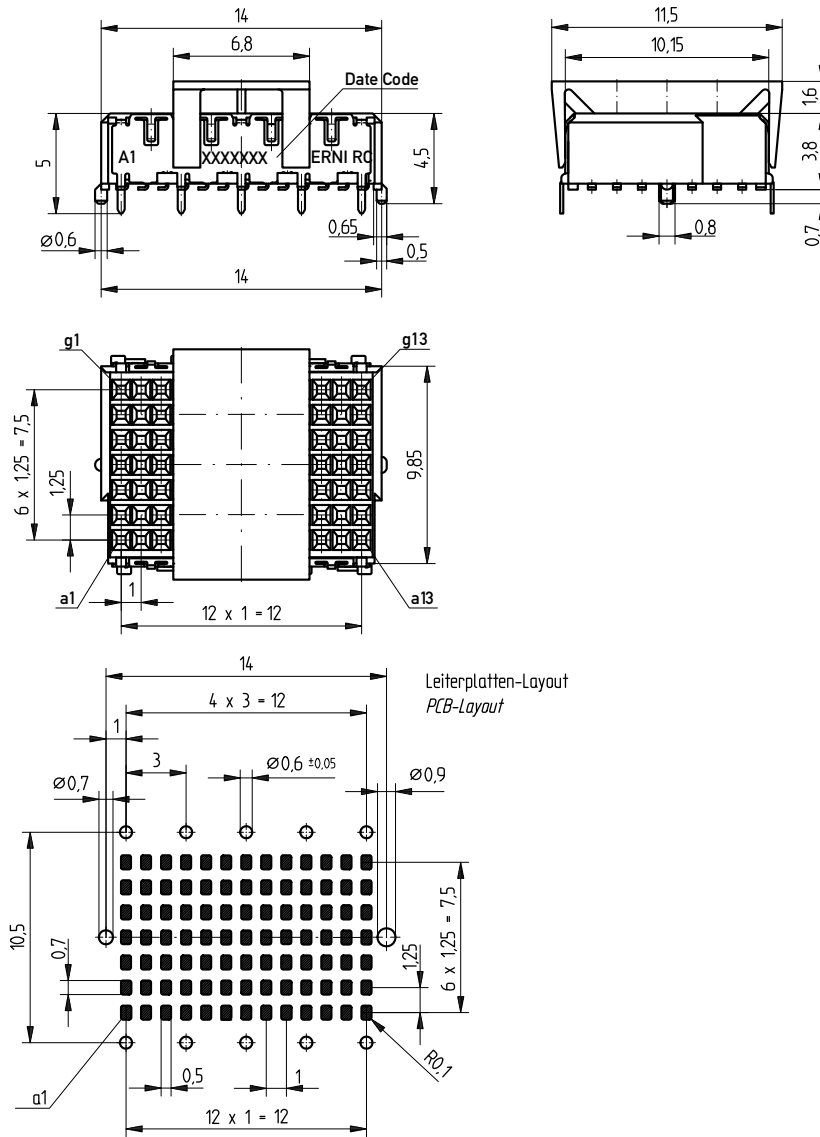

All dimensions in mm



MicroSpeed® - 1.0 mm High Speed Mezzanine Connector System for 10 GBit/s

7-Row Female Connectors

Dimensional Drawings

133 Pin Connector with SMT Ground Pins

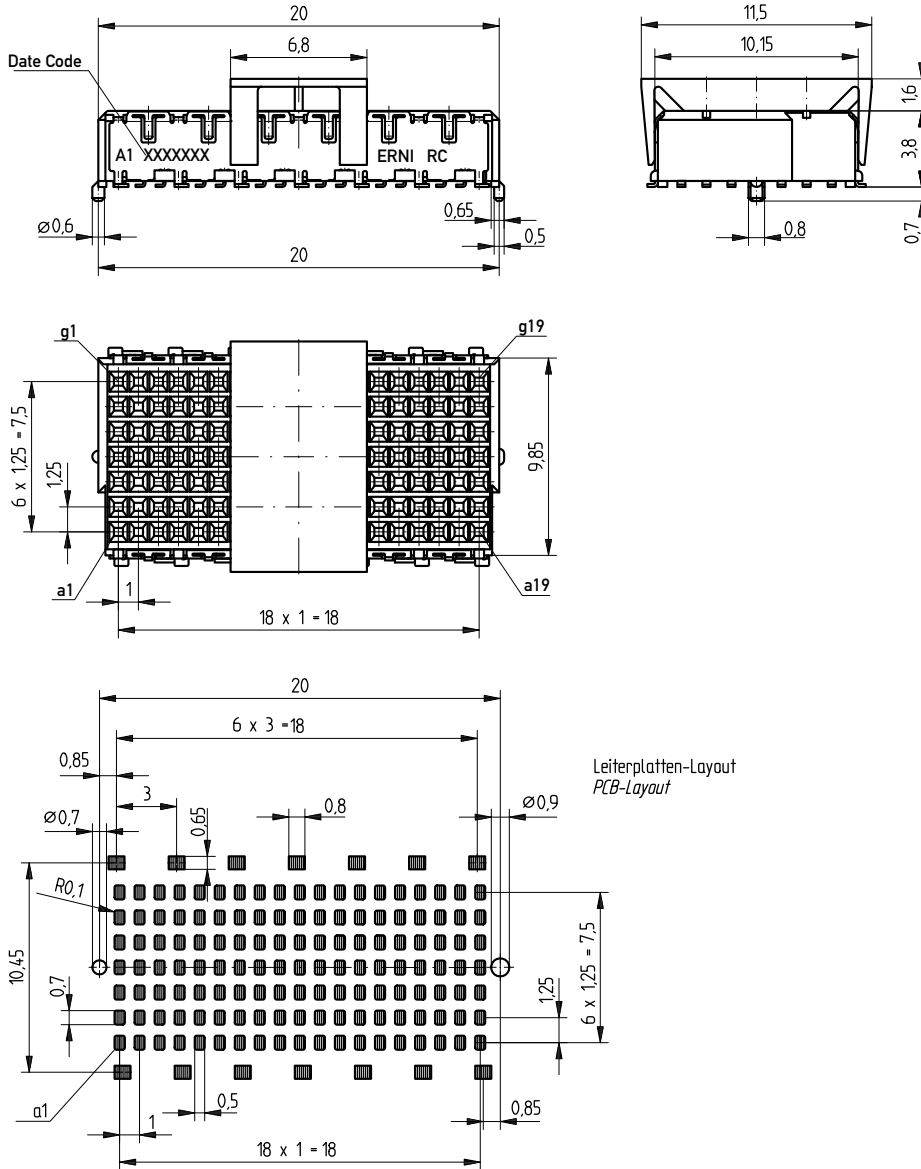

All dimensions in mm



MicroSpeed® - 1.0 mm High Speed Mezzanine Connector System for 10 GBit/s

7-Row Female Connectors

Dimensional Drawings

133 Pin Connector with THR Ground Pins

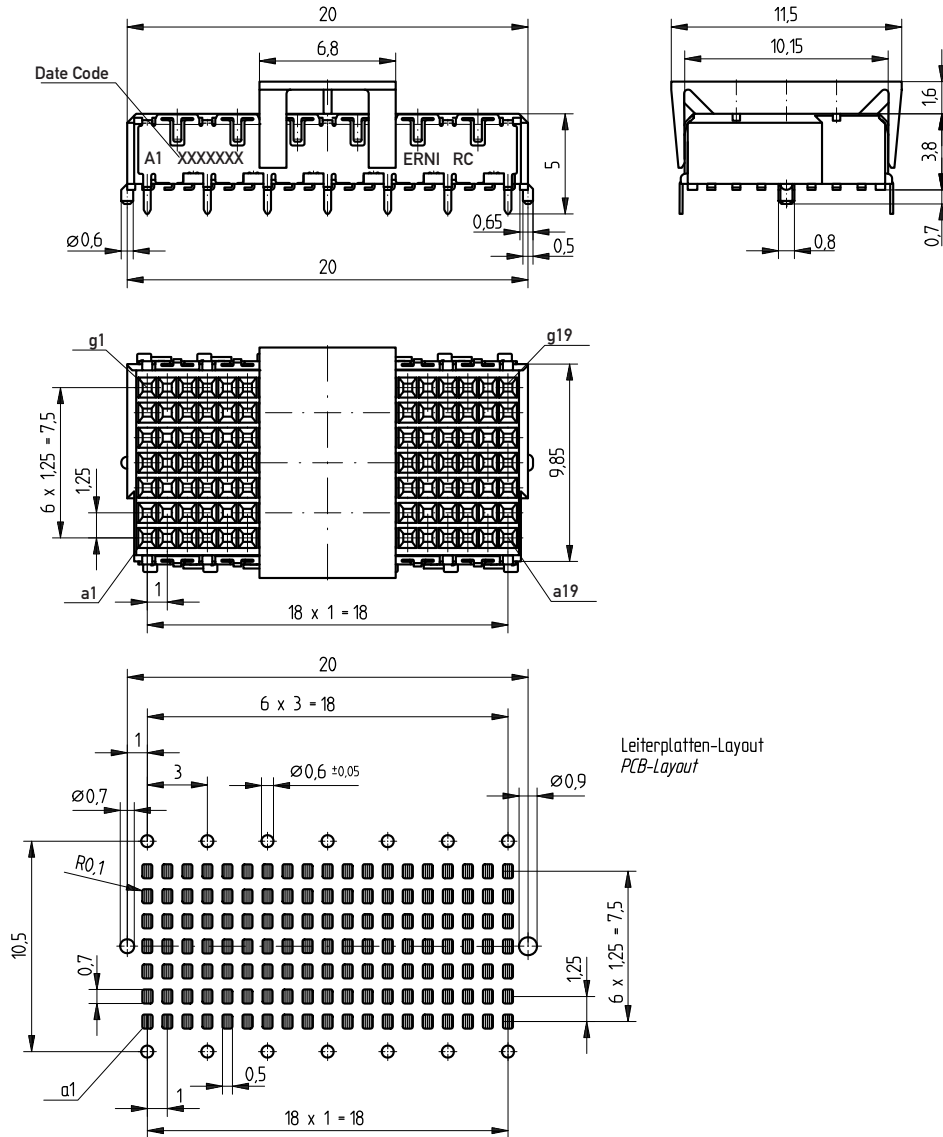

All dimensions in mm

MicroSpeed® - 1.0 mm High Speed Mezzanine Connector System for 10 GBit/s

7-Row Female Connectors

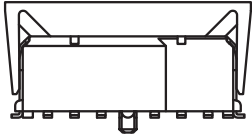
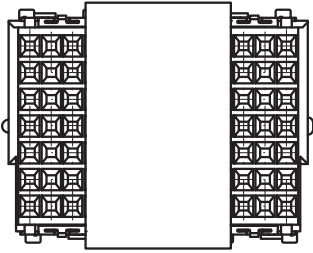
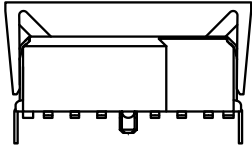
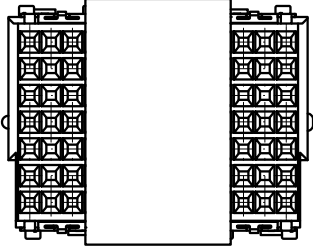
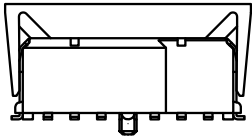
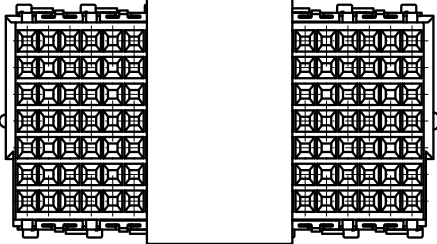
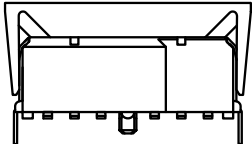
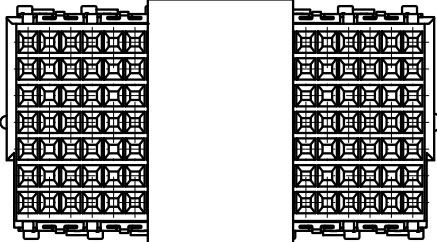

Configuration	Number of Pins	Termination	Unmated Stacking Height	Part Number
	91	SMT		224209
<p>Female connector, tape and reel 440 pcs/reel</p>				
	91	SMT/THR		234097
<p>Female connector, tape and reel 440 pcs/reel</p>				
	133	SMT		214352
<p>Female connector, tape and reel 440 pcs/reel</p>				
	133	SMT/THR		234098
<p>Female connector, tape and reel 440 pcs/reel</p>				

MicroSpeed® - 1.0 mm High Speed Mezzanine Connector System for 10 GBit/s

Equipment and Testing



Evaluation Kit

The evaluation kit contains the test boards and a CD Rom with the description of the measurement set up and relevant technical information. The boards are designed in a manner that allows full de-embedding of the parasitic influence of the transmission lines and the SMA connectors on the board. This ensures properly measured values of the connector system itself without any negative influence of the test fixture. Measurements can be performed with a Time Domain Reflectometer in the Time domain or a Vector Network Analyzer in the frequency domain.

Configuration

Part Number

Evaluation Kit

166206

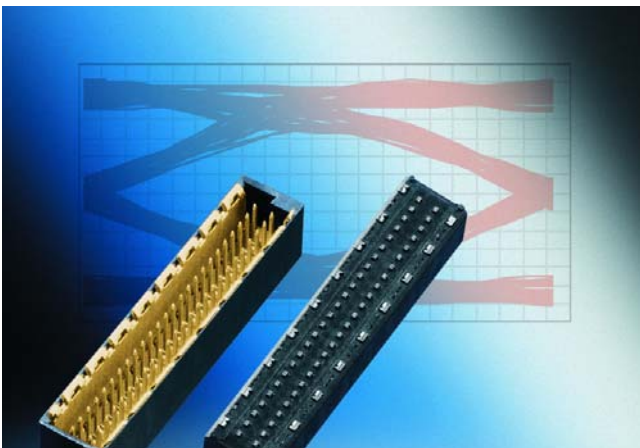

Simulation Models

The ERNI MicroSpeed simulation models are provided in three different formats:

1. Spice compatible models based on L, R, C and K elements in accordance to UC Berkeley Spice3f5 standard.
2. S-parameter data in Touchstone file format
3. IBIS data for single line model

For each format, two different types of simulation models are given:

1. A set of very compact models, which represents only one signal pair (e.g. a-b) of the connector. These models should be used, if only the reflection behavior and the impedance matching of the connector should be analyzed. They do not slow down a simulator significantly. This model is available on the ERNI web page.
2. A set of models which represent more signals. This model fully represents the connector behavior including:
 - impedance matching
 - crosstalk behavior
 - ground bounce

This model is only available when the customer has signed an NDA. The usage of each model is explained in the header part of the appropriate library file.

Configuration

Part Number

CD with Simulation Models for MicroSpeed Connectors

204709



ERMEC, S.L. BARCELONA
 C/ Francesc Teixidó, 22
 E-08918 Badalona
 (Spain)

Tel.: (+34) 902 450 160
 Fax: (+34) 902 433 088
info@ermec.com
www.ermec.com

ERMEC, S.L. MADRID
 C/ Sagasta, 8, 1ª planta
 E-28004 Madrid
 (Spain)

PORTUGAL
portugal@ermec.com
 BILBAO
bilbao@ermec.com



MicroSpeed® - 1.0 mm High Speed Mezzanine Connector System for 10 GBit/s

Part Number Index

Part Number	Page
144662	22
144663	22
144680	13
144681	13
166206	29
204709	29
214352	28
214355	19
224209	28
224212	19
224512	22
224513	22
224514	23
224515	23
224516	23
224517	23
224557	13
224558	13
224559	14
224560	14
224561	14
224562	14
234097	28
234098	28
234752	19
234753	19



Member



VMEbus INTERNATIONAL TRADE ASSOCIATION





ERNI Electronics GmbH

Seestrasse 9
73099 Adelberg/Germany
Tel +49 7166 50-0
Fax +49 7166 50-282
info@erni.de

Europe South America Africa Japan

ERNI Electronics, Inc.

2201 Westwood Ave
Richmond, VA 23230/USA
Tel +1 804 228-4100
Fax +1 804 228-4099
info.usa@erni.com

North America Canada Mexico

ERNI Asia Holding Pte Ltd.

Blk 4008 Ang Mo Kio Avenue 10
#04-01/02 Techplace I
Singapore 569625
Tel +65 6 555 5885
Fax +65 6 555 5995
info@erni-asia.com

Asia

www.erni.com

© ERNI Electronics GmbH 2007 • Printed in Germany. A policy of continuous improvement is followed and the right to alter any published data without notice is reserved.
ERNI®, MicroStac®, MicroSpeed®, MiniBridge®, MaxiBridge®, ERmet®, ERmet ZD®, ERbic® and ERNIPRESS® are trademarks (registered or applied for in various countries) of ERNI Electronics GmbH.