

Pin Headers

2.54 mm Soldered Pin Header Versions



2.54 mm Pin Headers

DESCRIPTION

GENERAL



Vertical and Right Angle Pin Headers

ERNI pin connectors are one- and two-row plastic strips assembled with square 0.64 x 0.64mm pins. The connector side is completely gold-plated, and the terminal side is plated with gold flash. Unshrouded headers are available in different connection lengths and termination types. Single and dual row connectors can easily be broken off to the desired number of pins that is required, by using predetermined break points. Any number of pin connectors can be arranged next to each other in a row. ERNI supplies many customer-specific solutions of this kind.

- Straight versions with solder, THR and SMT termination
- Horizontal versions with solder, THR and SMT termination
- Single or dual row
- DIN and LPV intermateability
- Flexible manufacturing process
- High temperature material

2.54 mm Pin Headers

DESCRIPTION

TECHNICAL DETAILS

Pitch	2.54 mm
No. of Pins	2 to 14 in step of 2 for Single Row, 4 to 20 in step of 2 for Dual Row
Packaging	Poly bag, Tube or Tape and reel
Current rating per contact	up to 3.0 A at 20 °C
Termination	SMT and THR
Variants	Single row vertical, Single row right angle, Dual row vertical, Dual row right angle

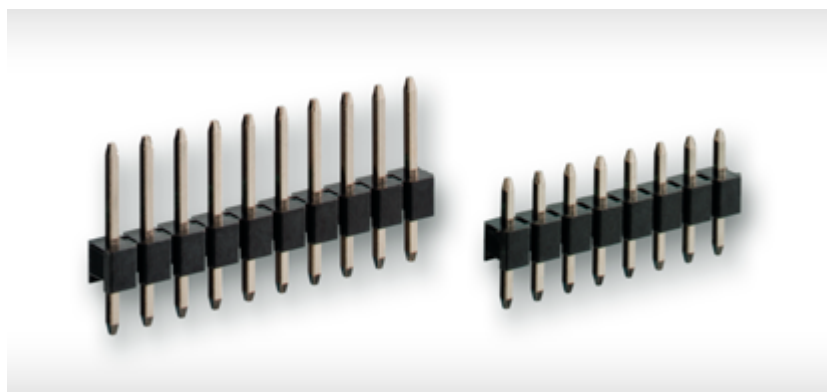

Two different mating lengths
(3mm and 6 mm)



2.54 mm Pin Headers

ELECTRICAL AND MECHANICAL CHARACTERISTICS

TECHNICAL DATA

Description	Standard	Single Row and Dual Row Pin Headers
Temperature range		-40 / 105 °C
Current rating per contact	IEC60512-5-2 test 5b	3.0 A at 20 °C
Air- and creepage distance		1.8 mm
Operating voltage	IEC 60664	The permissible operating voltages depend on the customer application and on the applicable or specified safety requirements. Insulation coordination according to IEC 60664-1 has to be regarded for the complete electrical device. Therefore, the maximum creepage and clearance distances of the mated connectors are specified for consideration as a part of the whole current path. In practice, reductions in creepage or clearance distances may occur due to the conductive pattern of the printed board or the wiring used, and have to be taken into account separately. As a result the creepage and clearance distances for the application may be reduced compared to those of the connector.
Dielectric strength	IEC 60512 test 4a	Contact – Contact 1000 V _{rms}
Contact resistance	IEC 60512 test 2a	< 20 mΩ
Insulation resistance	IEC 60512 test 3a	> 10 ³ MΩ
Mechanical operation	IEC 60512 test 9a	> 100 mating cycles for 10 μ ⁴ Au > 10 mating cycles for 0.8 μ ⁴ Au
Process Conditions		
Solder temperature (max.)	IEC 68-2-20	
Hand soldering temp. (max.)		3.5 s at 350 °C
Dip soldering temp. (max.)		10 s at 260 °C
Reflow soldering temp. (max.)	JEDEC J-STD-020C	20 - 40 s at 260 °C



2.54 mm Pin Headers

ELECTRICAL AND MECHANICAL CHARACTERISTICS

Description	Standard	Single Row and Dual Row Pin Headers
Housing Material		
Plastic material		PA9T black
UL flame rating		UL 94 V-0
Contact Material		
Base material		Brass
Mating area		Au plating over 30 - 80µ" Ni underplating
Termination area		Au flash over 30 - 80µ" Ni underplating

2.54 mm Pin Headers

SINGLE ROW, VERTICAL, SMT

PRODUCT SPECIFICATION

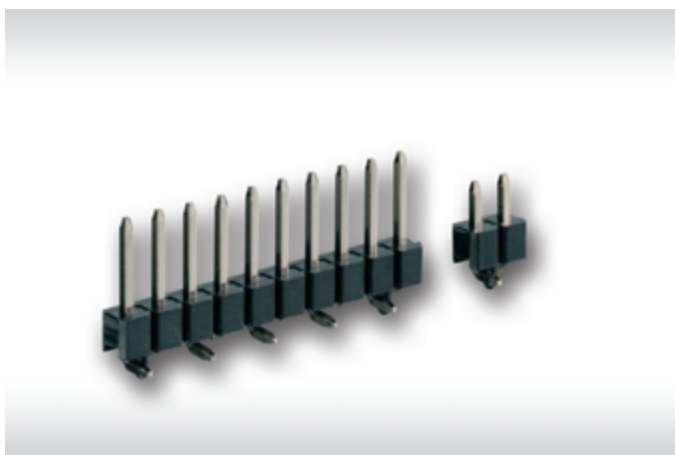

- Single row pin headers
- SMT termination
- With locating peg
- Two different mating lengths
- Fully automatic assembly

DIMENSIONAL DRAWINGS

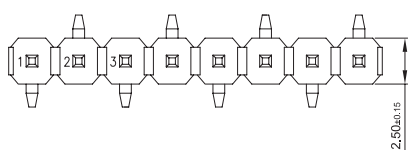

14	35.56	33.02	30.48
12	30.48	27.94	25.40
10	25.40	22.86	20.32
8	20.32	17.78	15.24
6	15.24	12.70	10.16
4	10.16	7.62	5.08
2	5.08	2.54	0.00
No of Pos.	DIM. G	DIM. H	DIM. M

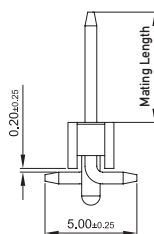
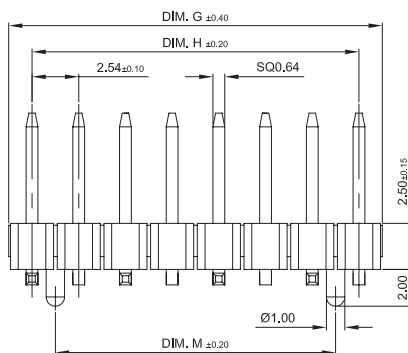

Recommended Layout

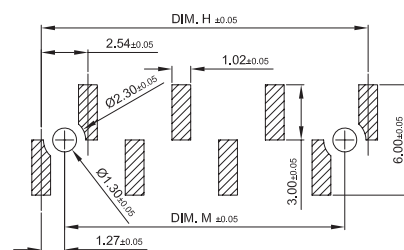

All dimensions in mm.



2.54 mm Pin Headers

SINGLE ROW, VERTICAL, SMT

ORDERING INFORMATION

No. of Pins	Mating Length (mm)	Mating Cycles (min.)	Packaging	Part Number
2	6	10	Tube	129133
4	6	10	Tube	129134
6	6	10	Tube	129135
8	6	10	Tube	129136
10	6	10	Tube	129137
12	6	10	Tube	129138
14	6	10	Tube	129139
2	6	10	Tape and reel	129140
4	6	10	Tape and reel	129141
6	6	10	Tape and reel	129142
8	6	10	Tape and reel	129143
10	6	10	Tape and reel	129144
12	6	10	Tape and reel	129145
14	6	10	Tape and reel	129146
2	6	100	Tube	129147
4	6	100	Tube	129148
6	6	100	Tube	129149
8	6	100	Tube	129150



2.54 mm Pin Headers

SINGLE ROW, VERTICAL, SMT —

No. of Pins	Mating Length (mm)	Mating Cycles (min.)	Packaging	Part Number
10	6	100	Tube	129151
12	6	100	Tube	129152
14	6	100	Tube	129153
2	6	100	Tape and reel	129154
4	6	100	Tape and reel	129155
6	6	100	Tape and reel	129156
8	6	100	Tape and reel	129157
10	6	100	Tape and reel	129158
12	6	100	Tape and reel	129159
14	6	100	Tape and reel	129160
2	3	10	Tube	129162
4	3	10	Tube	129163
6	3	10	Tube	129164
8	3	10	Tube	129165
10	3	10	Tube	129166
12	3	10	Tube	129167
14	3	10	Tube	129168
2	3	10	Tape and reel	129169
4	3	10	Tape and reel	129170
6	3	10	Tape and reel	129171



2.54 mm Pin Headers

SINGLE ROW, VERTICAL, SMT —

No. of Pins	Mating Length (mm)	Mating Cycles (min.)	Packaging	Part Number
8	3	10	Tape and reel	129172
10	3	10	Tape and reel	129173
12	3	10	Tape and reel	129174
14	3	10	Tape and reel	129175
2	3	100	Tube	129176
4	3	100	Tube	129177
6	3	100	Tube	129178
8	3	100	Tube	129179
10	3	100	Tube	129180
12	3	100	Tube	129181
14	3	100	Tube	129182
2	3	100	Tape and reel	129183
4	3	100	Tape and reel	129184
6	3	100	Tape and reel	129185
8	3	100	Tape and reel	129186
10	3	100	Tape and reel	129187
12	3	100	Tape and reel	129188
14	3	100	Tape and reel	129189

2.54 mm Pin Headers

SINGLE ROW, VERTICAL, THR

PRODUCT SPECIFICATION

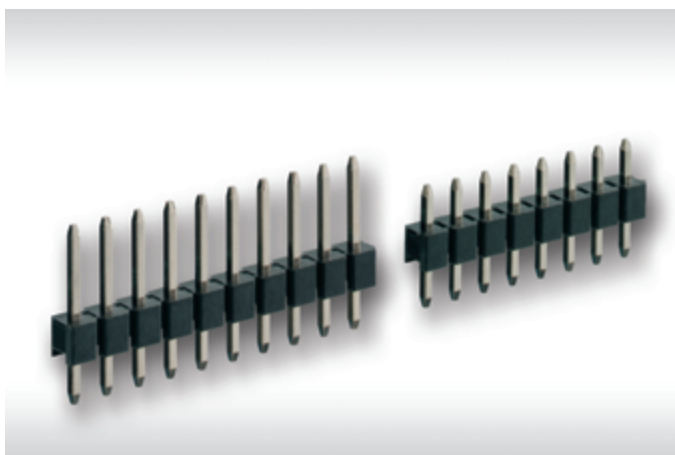

- Single row pin headers
- THR termination
- Two different mating lengths
- Fully automatic assembly

DIMENSIONAL DRAWINGS

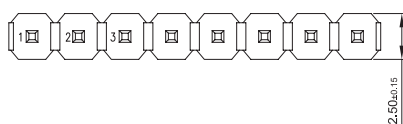

14	35,56	33,02
12	30,48	27,94
10	25,40	22,86
8	20,32	17,78
6	15,24	12,70
4	10,16	7,62
2	5,08	2,54
No of Pos.	DIM. G	DIM. H

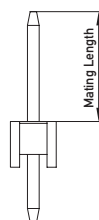
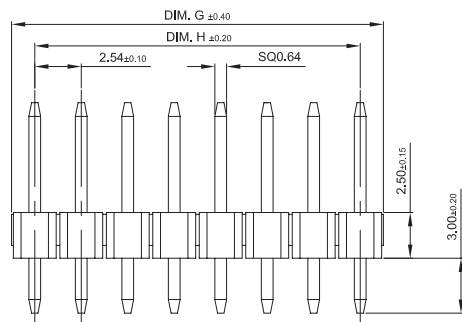

Recommended Layout



All dimensions in mm.



2.54 mm Pin Headers

SINGLE ROW, VERTICAL, THR —

ORDERING INFORMATION

No. of Pins	Mating Length (mm)	Mating Cycles (min.)	Packaging	Part Number
2	6	10	Tube	129397
4	6	10	Tube	129398
6	6	10	Tube	129399
8	6	10	Tube	129400
10	6	10	Tube	129401
12	6	10	Tube	129402
14	6	10	Tube	129403
2	6	10	Tape and reel	129404
4	6	10	Tape and reel	129405
6	6	10	Tape and reel	129406
8	6	10	Tape and reel	129407
10	6	10	Tape and reel	129408
12	6	10	Tape and reel	129409
14	6	10	Tape and reel	129410
2	6	10	Poly bag	129411
4	6	10	Poly bag	129412
6	6	10	Poly bag	129413
8	6	10	Poly bag	129414



2.54 mm Pin Headers

SINGLE ROW, VERTICAL, THR —

No. of Pins	Mating Length (mm)	Mating Cycles (min.)	Packaging	Part Number
10	6	10	Poly bag	129415
12	6	10	Poly bag	129416
14	6	10	Poly bag	129417
2	6	100	Tube	129418
4	6	100	Tube	129419
6	6	100	Tube	129420
8	6	100	Tube	129421
10	6	100	Tube	129422
12	6	100	Tube	129423
14	6	100	Tube	129424
2	6	100	Tape and reel	129425
4	6	100	Tape and reel	129426
6	6	100	Tape and reel	129427
8	6	100	Tape and reel	129428
10	6	100	Tape and reel	129429
12	6	100	Tape and reel	129430
14	6	100	Tape and reel	129431
2	6	100	Poly bag	129432
4	6	100	Poly bag	129433
6	6	100	Poly bag	129434



2.54 mm Pin Headers

SINGLE ROW, VERTICAL, THR —

No. of Pins	Mating Length (mm)	Mating Cycles (min.)	Packaging	Part Number
8	6	100	Poly bag	129435
10	6	100	Poly bag	129436
12	6	100	Poly bag	129437
14	6	100	Poly bag	129438
2	3	10	Tube	129440
4	3	10	Tube	129441
6	3	10	Tube	129442
8	3	10	Tube	129443
10	3	10	Tube	129444
12	3	10	Tube	129445
14	3	10	Tube	129446
2	3	10	Tape and reel	129447
4	3	10	Tape and reel	129448
6	3	10	Tape and reel	129449
8	3	10	Tape and reel	129450
10	3	10	Tape and reel	129451
12	3	10	Tape and reel	129452
14	3	10	Tape and reel	129453
2	3	10	Poly bag	129454
4	3	10	Poly bag	129455



2.54 mm Pin Headers

SINGLE ROW, VERTICAL, THR —

No. of Pins	Mating Length (mm)	Mating Cycles (min.)	Packaging	Part Number
6	3	10	Poly bag	129456
8	3	10	Poly bag	129457
10	3	10	Poly bag	129458
12	3	10	Poly bag	129459
14	3	10	Poly bag	129460
2	3	100	Tube	129461
4	3	100	Tube	129462
6	3	100	Tube	129463
8	3	100	Tube	129464
10	3	100	Tube	129465
12	3	100	Tube	129466
14	3	100	Tube	129467
2	3	100	Tape and reel	129468
4	3	100	Tape and reel	129469
6	3	100	Tape and reel	129470
8	3	100	Tape and reel	129471
10	3	100	Tape and reel	129472
12	3	100	Tape and reel	129473
14	3	100	Tape and reel	129474
2	3	100	Poly bag	129475



2.54 mm Pin Headers

SINGLE ROW, VERTICAL, THR —

No. of Pins	Mating Length (mm)	Mating Cycles (min.)	Packaging	Part Number
4	3	100	Poly bag	129476
6	3	100	Poly bag	129477
8	3	100	Poly bag	129478
10	3	100	Poly bag	129479
12	3	100	Poly bag	129480
14	3	100	Poly bag	129481

2.54 mm Pin Headers

SINGLE ROW, RIGHT ANGLE, SMT

PRODUCT SPECIFICATION

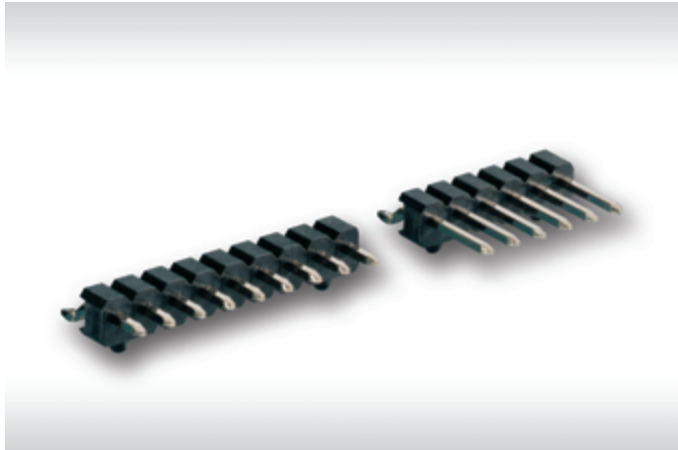

- Single row pin headers
- SMT termination
- With locating peg
- Two different mating lengths
- Fully automatic assembly

DIMENSIONAL DRAWINGS

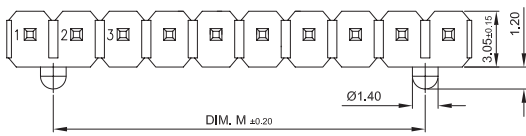

14	35.56	33.02	30.48
12	30.48	27.94	25.40
10	25.40	22.86	20.32
8	20.32	17.78	15.24
6	15.24	12.70	10.16
4	10.16	7.62	5.08
2	5.08	2.54	0.00
No of Pos.	DIM. G	DIM. H	DIM. M

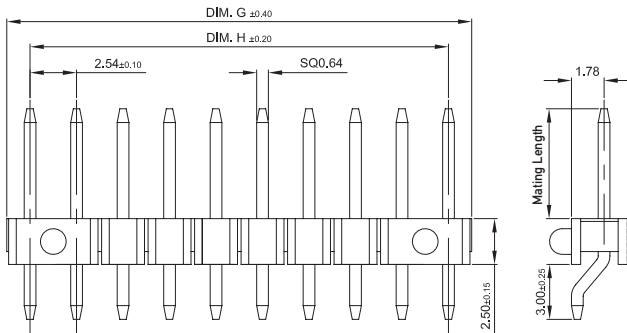

Recommended Layout

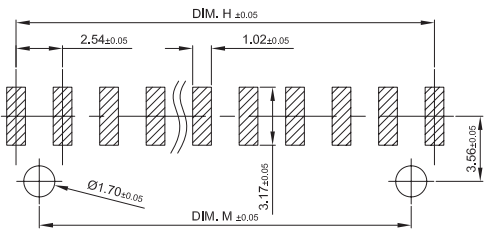

All dimensions in mm.



2.54 mm Pin Headers

SINGLE ROW, RIGHT ANGLE, SMT

ORDERING INFORMATION

No. of Pins	Mating Length (mm)	Mating Cycles (min.)	Packaging	Part Number
2	6	10	Tube	129001
4	6	10	Tube	129002
6	6	10	Tube	129003
8	6	10	Tube	129004
10	6	10	Tube	129005
12	6	10	Tube	129006
14	6	10	Tube	129007
2	6	10	Tape and reel	129008
4	6	10	Tape and reel	129009
6	6	10	Tape and reel	129010
8	6	10	Tape and reel	129011
10	6	10	Tape and reel	129012
12	6	10	Tape and reel	129013
14	6	10	Tape and reel	129014
2	6	100	Tube	129015
4	6	100	Tube	129016
6	6	100	Tube	129017
8	6	100	Tube	129018



2.54 mm Pin Headers

SINGLE ROW, RIGHT ANGLE, SMT

No. of Pins	Mating Length (mm)	Mating Cycles (min.)	Packaging	Part Number
10	6	100	Tube	129019
12	6	100	Tube	129020
14	6	100	Tube	129021
2	6	100	Tape and reel	129022
4	6	100	Tape and reel	129023
6	6	100	Tape and reel	129024
8	6	100	Tape and reel	129025
10	6	100	Tape and reel	129026
12	6	100	Tape and reel	129027
14	6	100	Tape and reel	129028
2	3	10	Tube	129030
4	3	10	Tube	129031
6	3	10	Tube	129032
8	3	10	Tube	129033
10	3	10	Tube	129034
12	3	10	Tube	129035
14	3	10	Tube	129036
2	3	10	Tape and reel	129037
4	3	10	Tape and reel	129038
6	3	10	Tape and reel	129039



2.54 mm Pin Headers

SINGLE ROW, RIGHT ANGLE, SMT

No. of Pins	Mating Length (mm)	Mating Cycles (min.)	Packaging	Part Number
8	3	10	Tape and reel	129040
10	3	10	Tape and reel	129041
12	3	10	Tape and reel	129042
14	3	10	Tape and reel	129043
2	3	100	Tube	129044
4	3	100	Tube	129045
6	3	100	Tube	129046
8	3	100	Tube	129047
10	3	100	Tube	129048
12	3	100	Tube	129049
14	3	100	Tube	129050
2	3	100	Tape and reel	129051
4	3	100	Tape and reel	129052
6	3	100	Tape and reel	129053
8	3	100	Tape and reel	129054
10	3	100	Tape and reel	129055
12	3	100	Tape and reel	129056
14	3	100	Tape and reel	129057

2.54 mm Pin Headers

SINGLE ROW, RIGHT ANGLE, THR

PRODUCT SPECIFICATION

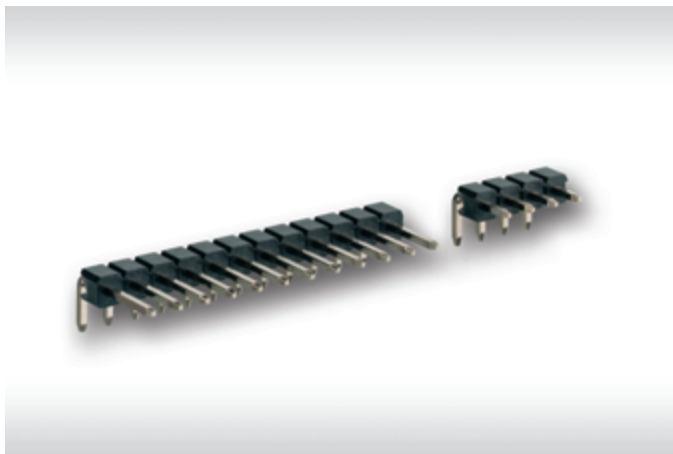

- Single row pin headers
- THR termination
- Two different mating lengths
- Fully automatic assembly

DIMENSIONAL DRAWINGS

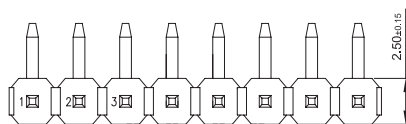

14	35,56	33,02
12	30,48	27,94
10	25,40	22,86
8	20,32	17,78
6	15,24	12,70
4	10,16	7,62
2	5,08	2,54
No of Pos.	DIM. G	DIM. H

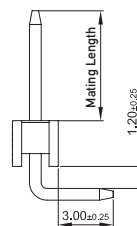
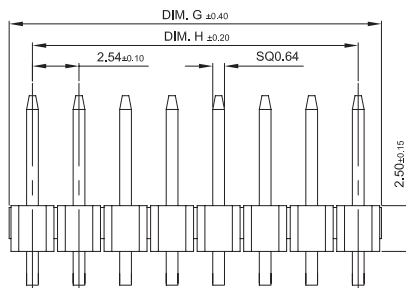

Recommended Layout



All dimensions in mm.



2.54 mm Pin Headers

SINGLE ROW, RIGHT ANGLE, THR —

ORDERING INFORMATION

No. of Pins	Mating Length (mm)	Mating Cycles (min.)	Packaging	Part Number
2	6	10	Tube	129265
4	6	10	Tube	129266
6	6	10	Tube	129267
8	6	10	Tube	129268
10	6	10	Tube	129269
12	6	10	Tube	129270
14	6	10	Tube	129271
2	6	10	Tape and reel	129272
4	6	10	Tape and reel	129273
6	6	10	Tape and reel	129274
8	6	10	Tape and reel	129275
10	6	10	Tape and reel	129276
12	6	10	Tape and reel	129277
14	6	10	Tape and reel	129278
2	6	100	Tube	129279
4	6	100	Tube	129280
6	6	100	Tube	129281
8	6	100	Tube	129282



2.54 mm Pin Headers

SINGLE ROW, RIGHT ANGLE, THR —

No. of Pins	Mating Length (mm)	Mating Cycles (min.)	Packaging	Part Number
10	6	100	Tube	129283
12	6	100	Tube	129284
14	6	100	Tube	129285
2	6	100	Tape and reel	129286
4	6	100	Tape and reel	129287
6	6	100	Tape and reel	129288
8	6	100	Tape and reel	129289
10	6	100	Tape and reel	129290
12	6	100	Tape and reel	129291
14	6	100	Tape and reel	129292
2	3	10	Tube	129294
4	3	10	Tube	129295
6	3	10	Tube	129296
8	3	10	Tube	129297
10	3	10	Tube	129298
12	3	10	Tube	129299
14	3	10	Tube	129300
2	3	10	Tape and reel	129301
4	3	10	Tape and reel	129302
6	3	10	Tape and reel	129303



2.54 mm Pin Headers

SINGLE ROW, RIGHT ANGLE, THR —

No. of Pins	Mating Length (mm)	Mating Cycles (min.)	Packaging	Part Number
8	3	10	Tape and reel	129304
10	3	10	Tape and reel	129305
12	3	10	Tape and reel	129306
14	3	100	Tape and reel	129307
2	3	100	Tube	129308
4	3	100	Tube	129309
6	3	100	Tube	129310
8	3	100	Tube	129311
10	3	100	Tube	129312
12	3	100	Tube	129313
14	3	100	Tube	129314
2	3	100	Tape and reel	129315
4	3	100	Tape and reel	129316
6	3	100	Tape and reel	129317
8	3	100	Tape and reel	129318
10	3	100	Tape and reel	129319
12	3	100	Tape and reel	129320
14	3	100	Tape and reel	129321

2.54 mm Pin Headers

DUAL ROW, VERTICAL, SMT

PRODUCT SPECIFICATION

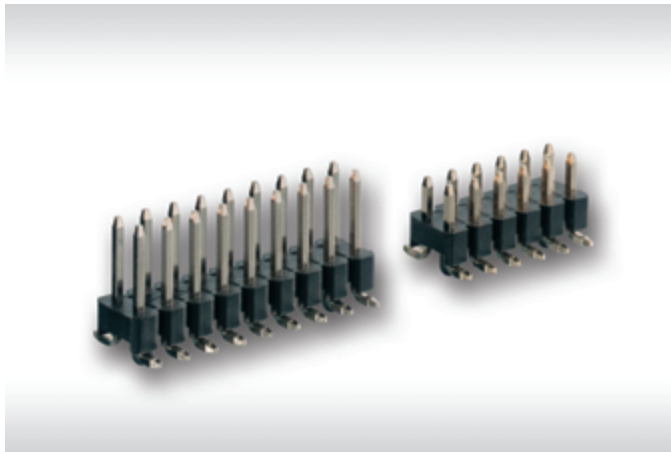

- Dual row pin headers
- SMT termination
- With locating peg
- Two different mating lengths
- Fully automatic assembly

DIMENSIONAL DRAWINGS

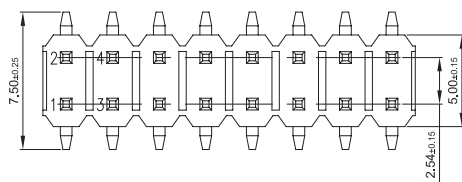

20	25.40	22.86	20.32
18	22.86	20.32	17.78
16	20.32	17.78	15.24
14	17.78	15.24	12.70
12	15.24	12.70	10.16
10	12.70	10.16	7.62
8	10.16	7.62	5.08
6	7.62	5.08	2.54
4	5.08	2.54	0.00
No of Pos.	DIM. G	DIM. H	DIM. M

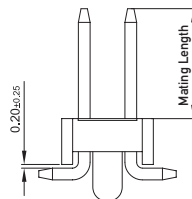
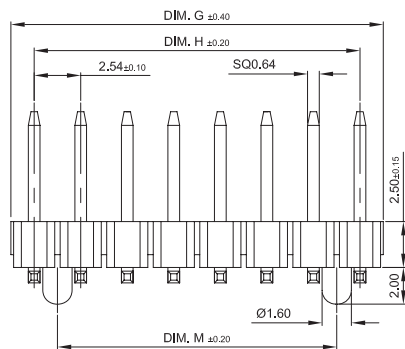

Recommended Layout

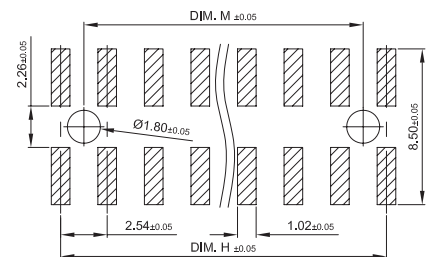

All dimensions in mm.



2.54 mm Pin Headers

DUAL ROW, VERTICAL, SMT —

ORDERING INFORMATION

No. of Pins	Mating Length (mm)	Mating Cycles (min.)	Packaging	Part Number
4	6	10	Tube	129191
6	6	10	Tube	129192
8	6	10	Tube	129193
10	6	10	Tube	129194
12	6	10	Tube	129195
14	6	10	Tube	129196
16	6	10	Tube	129197
18	6	10	Tube	129198
20	6	10	Tube	129199
4	6	10	Tape and reel	129200
6	6	10	Tape and reel	129201
8	6	10	Tape and reel	129202
10	6	10	Tape and reel	129203
12	6	10	Tape and reel	129204
14	6	10	Tape and reel	129205
16	6	10	Tape and reel	129206
18	6	10	Tape and reel	129207
20	6	10	Tape and reel	129208



2.54 mm Pin Headers

DUAL ROW, VERTICAL, SMT —

No. of Pins	Mating Length (mm)	Mating Cycles (min.)	Packaging	Part Number
4	6	100	Tube	129209
6	6	100	Tube	129210
8	6	100	Tube	129211
10	6	100	Tube	129212
12	6	100	Tube	129213
14	6	100	Tube	129214
16	6	100	Tube	129215
18	6	100	Tube	129216
20	6	100	Tube	129217
4	6	100	Tape and reel	129218
6	6	100	Tape and reel	129219
8	6	100	Tape and reel	129220
10	6	100	Tape and reel	129221
12	6	100	Tape and reel	129222
14	6	100	Tape and reel	129223
16	6	100	Tape and reel	129224
18	6	100	Tape and reel	129225
20	6	100	Tape and reel	129226
4	3	10	Tube	129228
6	3	10	Tube	129229



2.54 mm Pin Headers

DUAL ROW, VERTICAL, SMT —

No. of Pins	Mating Length (mm)	Mating Cycles (min.)	Packaging	Part Number
8	3	10	Tube	129230
10	3	10	Tube	129231
12	3	10	Tube	129232
14	3	10	Tube	129233
16	3	10	Tube	129234
18	3	10	Tube	129235
20	3	10	Tube	129236
4	3	10	Tape and reel	129237
6	3	10	Tape and reel	129238
8	3	10	Tape and reel	129239
10	3	10	Tape and reel	129240
12	3	10	Tape and reel	129241
14	3	10	Tape and reel	129242
16	3	10	Tape and reel	129243
18	3	10	Tape and reel	129244
20	3	10	Tape and reel	129245
4	3	100	Tube	129246
6	3	100	Tube	129247
8	3	100	Tube	129248
10	3	100	Tube	129249

2.54 mm Pin Headers

DUAL ROW, VERTICAL, SMT —

No. of Pins	Mating Length (mm)	Mating Cycles (min.)	Packaging	Part Number
12	3	100	Tube	129250
14	3	100	Tube	129251
16	3	100	Tube	129252
18	3	100	Tube	129253
20	3	100	Tube	129254
4	3	100	Tape and reel	129255
6	3	100	Tape and reel	129256
8	3	100	Tape and reel	129257
10	3	100	Tape and reel	129258
12	3	100	Tape and reel	129259
14	3	100	Tape and reel	129260
16	3	100	Tape and reel	129261
18	3	100	Tape and reel	129262
20	3	100	Tape and reel	129263

2.54 mm Pin Headers

DUAL ROW, VERTICAL, THR

PRODUCT SPECIFICATION



- Dual row pin headers
- THR termination
- Two different mating lengths
- Fully automatic assembly

DIMENSIONAL DRAWINGS

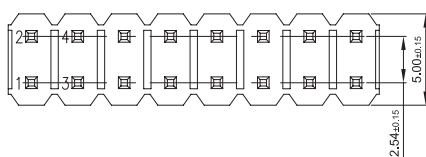

20	25,40	22,86
18	22,86	20,32
16	20,32	17,78
14	17,78	15,24
12	15,24	12,70
10	12,70	10,16
8	10,16	7,62
6	7,62	5,08
4	5,08	2,54
No of Pos.	DIM. G	DIM. H

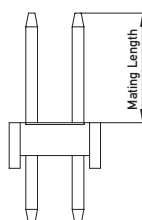
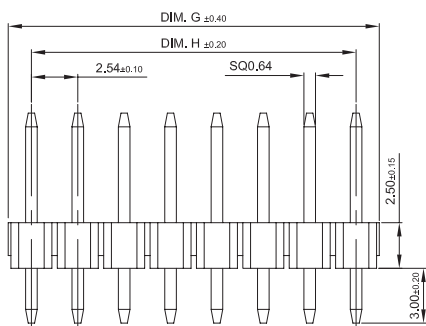

Recommended Layout

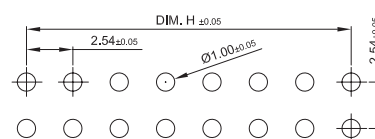

All dimensions in mm.



2.54 mm Pin Headers

DUAL ROW, VERTICAL, THR —

ORDERING INFORMATION

No. of Pins	Mating Length (mm)	Mating Cycles (min.)	Packaging	Part Number
4	6	10	Tube	129483
6	6	10	Tube	129484
8	6	10	Tube	129485
10	6	10	Tube	129486
12	6	10	Tube	129487
14	6	10	Tube	129488
16	6	10	Tube	129489
18	6	10	Tube	129490
20	6	10	Tube	129491
4	6	10	Tape and reel	129492
6	6	10	Tape and reel	129493
8	6	10	Tape and reel	129494
10	6	10	Tape and reel	129495
12	6	10	Tape and reel	129496
14	6	10	Tape and reel	129497
16	6	10	Tape and reel	129498
18	6	10	Tape and reel	129499
20	6	10	Tape and reel	129500



2.54 mm Pin Headers

DUAL ROW, VERTICAL, THR —

No. of Pins	Mating Length (mm)	Mating Cycles (min.)	Packaging	Part Number
4	6	10	Poly bag	129501
6	6	10	Poly bag	129502
8	6	10	Poly bag	129503
10	6	10	Poly bag	129504
12	6	10	Poly bag	129505
14	6	10	Poly bag	129506
16	6	10	Poly bag	129507
18	6	10	Poly bag	129508
20	6	10	Poly bag	129509
4	6	100	Tube	129510
6	6	100	Tube	129511
8	6	100	Tube	129512
10	6	100	Tube	129513
12	6	100	Tube	129514
14	6	100	Tube	129515
16	6	100	Tube	129516
18	6	100	Tube	129517
20	6	100	Tube	129518
4	6	100	Tape and reel	129519
6	6	100	Tape and reel	129520



2.54 mm Pin Headers

DUAL ROW, VERTICAL, THR —

No. of Pins	Mating Length (mm)	Mating Cycles (min.)	Packaging	Part Number
8	6	100	Tape and reel	129521
10	6	100	Tape and reel	129522
12	6	100	Tape and reel	129523
14	6	100	Tape and reel	129524
16	6	100	Tape and reel	129525
18	6	100	Tape and reel	129526
20	6	100	Tape and reel	129527
4	6	100	Poly bag	129528
6	6	100	Poly bag	129529
8	6	100	Poly bag	129530
10	6	100	Poly bag	129531
12	6	100	Poly bag	129532
14	6	100	Poly bag	129533
16	6	100	Poly bag	129534
18	6	100	Poly bag	129535
20	6	100	Poly bag	129536
4	3	10	Tube	129538
6	3	10	Tube	129539
8	3	10	Tube	129540
10	3	10	Tube	129541



2.54 mm Pin Headers

DUAL ROW, VERTICAL, THR —

No. of Pins	Mating Length (mm)	Mating Cycles (min.)	Packaging	Part Number
12	3	10	Tube	129542
14	3	10	Tube	129543
16	3	10	Tube	129544
18	3	10	Tube	129545
20	3	10	Tube	129546
4	3	10	Tape and reel	129547
6	3	10	Tape and reel	129548
8	3	10	Tape and reel	129549
10	3	10	Tape and reel	129550
12	3	10	Tape and reel	129551
14	3	10	Tape and reel	129552
16	3	10	Tape and reel	129553
18	3	10	Tape and reel	129554
20	3	10	Tape and reel	129555
4	3	10	Poly bag	129556
6	3	10	Poly bag	129557
8	3	10	Poly bag	129558
10	3	10	Poly bag	129559
12	3	10	Poly bag	129560
14	3	10	Poly bag	129561



2.54 mm Pin Headers

DUAL ROW, VERTICAL, THR —

No. of Pins	Mating Length (mm)	Mating Cycles (min.)	Packaging	Part Number
16	3	10	Poly bag	129562
18	3	10	Poly bag	129563
20	3	10	Poly bag	129564
4	3	100	Tube	129565
6	3	100	Tube	129566
8	3	100	Tube	129567
10	3	100	Tube	129568
12	3	100	Tube	129569
14	3	100	Tube	129570
16	3	100	Tube	129571
18	3	100	Tube	129572
20	3	100	Tube	129573
4	3	100	Tape and reel	129574
6	3	100	Tape and reel	129575
8	3	100	Tape and reel	129576
10	3	100	Tape and reel	129577
12	3	100	Tape and reel	129578
14	3	100	Tape and reel	129579
16	3	100	Tape and reel	129580
18	3	100	Tape and reel	129581



2.54 mm Pin Headers

DUAL ROW, VERTICAL, THR —

No. of Pins	Mating Length (mm)	Mating Cycles (min.)	Packaging	Part Number
20	3	100	Tape and reel	129582
4	3	100	Poly bag	129583
6	3	100	Poly bag	129584
8	3	100	Poly bag	129585
10	3	100	Poly bag	129586
12	3	100	Poly bag	129587
14	3	100	Poly bag	129588
16	3	100	Poly bag	129589
18	3	100	Poly bag	129590
20	3	100	Poly bag	129591

2.54 mm Pin Headers

DUAL ROW, RIGHT ANGLE, SMT

PRODUCT SPECIFICATION



- Dual row pin headers
- SMT termination
- With locating peg
- Two different mating lengths
- Fully automatic assembly

DIMENSIONAL DRAWINGS

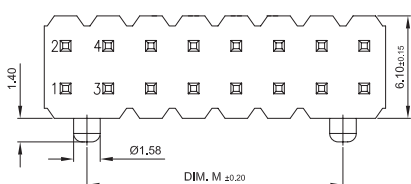

20	25.40	22.86	20.32
18	22.86	20.32	17.78
16	20.32	17.78	15.24
14	17.78	15.24	12.70
12	15.24	12.70	10.16
10	12.70	10.16	7.62
8	10.16	7.62	5.08
6	7.62	5.08	2.54
4	5.08	2.54	0.00
No of Pos.	DIM. G	DIM. H	DIM. M

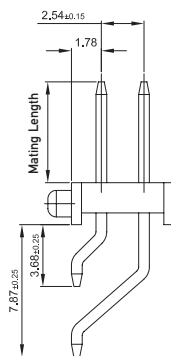
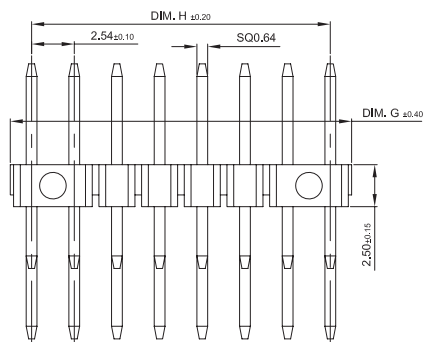

Recommended Layout

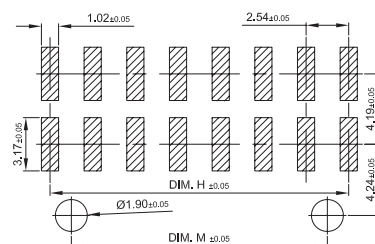

All dimensions in mm.



2.54 mm Pin Headers

DUAL ROW, RIGHT ANGLE, SMT

ORDERING INFORMATION

No. of Pins	Mating Length (mm)	Mating Cycles (min.)	Packaging	Part Number
4	6	10	Tube	129059
6	6	10	Tube	129060
8	6	10	Tube	129061
10	6	10	Tube	129062
12	6	10	Tube	129063
14	6	10	Tube	129064
16	6	10	Tube	129065
18	6	10	Tube	129066
20	6	10	Tube	129067
4	6	10	Tape and reel	129068
6	6	10	Tape and reel	129069
8	6	10	Tape and reel	129070
10	6	10	Tape and reel	129071
12	6	10	Tape and reel	129072
14	6	10	Tape and reel	129073
16	6	10	Tape and reel	129074
18	6	10	Tape and reel	129075
20	6	10	Tape and reel	129076



2.54 mm Pin Headers

DUAL ROW, RIGHT ANGLE, SMT

No. of Pins	Mating Length (mm)	Mating Cycles (min.)	Packaging	Part Number
4	6	100	Tube	129077
6	6	100	Tube	129078
8	6	100	Tube	129079
10	6	100	Tube	129080
12	6	100	Tube	129081
14	6	100	Tube	129082
16	6	100	Tube	129083
18	6	100	Tube	129084
20	6	100	Tube	129085
4	6	100	Tape and reel	129086
6	6	100	Tape and reel	129087
8	6	100	Tape and reel	129088
10	6	100	Tape and reel	129089
12	6	100	Tape and reel	129090
14	6	100	Tape and reel	129091
16	6	100	Tape and reel	129092
18	6	100	Tape and reel	129093
20	6	100	Tape and reel	129094
4	3	10	Tube	129096
6	3	10	Tube	129097



2.54 mm Pin Headers

DUAL ROW, RIGHT ANGLE, SMT

No. of Pins	Mating Length (mm)	Mating Cycles (min.)	Packaging	Part Number
8	3	10	Tube	129098
10	3	10	Tube	129099
12	3	10	Tube	129100
14	3	10	Tube	129101
16	3	10	Tube	129102
18	3	10	Tube	129103
20	3	10	Tube	129104
4	3	10	Tape and reel	129105
6	3	10	Tape and reel	129106
8	3	10	Tape and reel	129107
10	3	10	Tape and reel	129108
12	3	10	Tape and reel	129109
14	3	10	Tape and reel	129110
16	3	10	Tape and reel	129111
18	3	10	Tape and reel	129112
20	3	10	Tape and reel	129113
4	3	100	Tube	129114
6	3	100	Tube	129115
8	3	100	Tube	129116
10	3	100	Tube	129117



2.54 mm Pin Headers

DUAL ROW, RIGHT ANGLE, SMT —

No. of Pins	Mating Length (mm)	Mating Cycles (min.)	Packaging	Part Number
12	3	100	Tube	129118
14	3	100	Tube	129119
16	3	100	Tube	129120
18	3	100	Tube	129121
20	3	100	Tube	129122
4	3	100	Tape and reel	129123
6	3	100	Tape and reel	129124
8	3	100	Tape and reel	129125
10	3	100	Tape and reel	129126
12	3	100	Tape and reel	129127
14	3	100	Tape and reel	129128
16	3	100	Tape and reel	129129
18	3	100	Tape and reel	129130
20	3	100	Tape and reel	129131

2.54 mm Pin Headers

DUAL ROW, RIGHT ANGLE, THR

PRODUCT SPECIFICATION

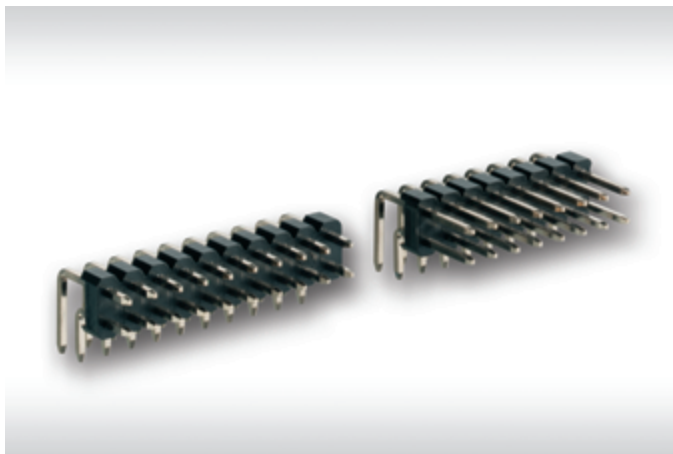

- Dual row pin headers
- THR termination
- Two different mating lengths
- Fully automatic assembly

DIMENSIONAL DRAWINGS

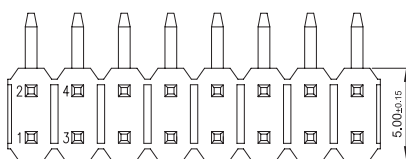

20	25.40	22.86
18	22.86	20.32
16	20.32	17.78
14	17.78	15.24
12	15.24	12.70
10	12.70	10.16
8	10.16	7.62
6	7.62	5.08
4	5.08	2.54
No of Pos.	DIM. G	DIM. H

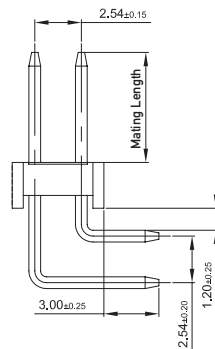
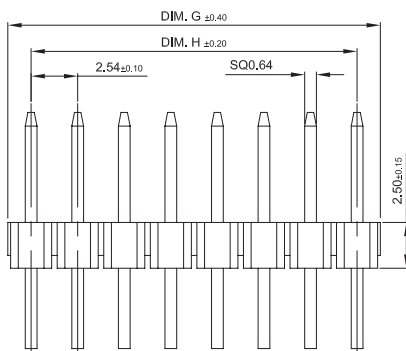

Recommended Layout

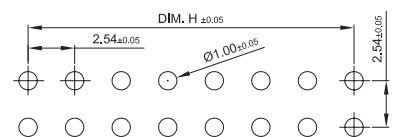

All dimensions in mm.



2.54 mm Pin Headers

DUAL ROW, RIGHT ANGLE, THR —

ORDERING INFORMATION

No. of Pins	Mating Length (mm)	Mating Cycles (min.)	Packaging	Part Number
4	6	10	Tube	129323
6	6	10	Tube	129324
8	6	10	Tube	129325
10	6	10	Tube	129326
12	6	10	Tube	129327
14	6	10	Tube	129328
16	6	10	Tube	129329
18	6	10	Tube	129330
20	6	10	Tube	129331
4	6	10	Tape and reel	129332
6	6	10	Tape and reel	129333
8	6	10	Tape and reel	129334
10	6	10	Tape and reel	129335
12	6	10	Tape and reel	129336
14	6	10	Tape and reel	129337
16	6	10	Tape and reel	129338
18	6	10	Tape and reel	129339
20	6	10	Tape and reel	129340



2.54 mm Pin Headers

DUAL ROW, RIGHT ANGLE, THR —

No. of Pins	Mating Length (mm)	Mating Cycles (min.)	Packaging	Part Number
4	6	100	Tube	129341
6	6	100	Tube	129342
8	6	100	Tube	129343
10	6	100	Tube	129344
12	6	100	Tube	129345
14	6	100	Tube	129346
16	6	100	Tube	129347
18	6	100	Tube	129348
20	6	100	Tube	129349
4	6	100	Tape and reel	129350
6	6	100	Tape and reel	129351
8	6	100	Tape and reel	129352
10	6	100	Tape and reel	129353
12	6	100	Tape and reel	129354
14	6	100	Tape and reel	129355
16	6	100	Tape and reel	129356
18	6	100	Tape and reel	129357
20	6	100	Tape and reel	129358
4	3	10	Tube	129360
6	3	10	Tube	129361



2.54 mm Pin Headers

DUAL ROW, RIGHT ANGLE, THR —

No. of Pins	Mating Length (mm)	Mating Cycles (min.)	Packaging	Part Number
8	3	10	Tube	129362
10	3	10	Tube	129363
12	3	10	Tube	129364
14	3	10	Tube	129365
16	3	10	Tube	129366
18	3	10	Tube	129367
20	3	10	Tube	129368
4	3	10	Tape and reel	129369
6	3	10	Tape and reel	129370
8	3	10	Tape and reel	129371
10	3	10	Tape and reel	129372
12	3	10	Tape and reel	129373
14	3	10	Tape and reel	129374
16	3	10	Tape and reel	129375
18	3	10	Tape and reel	129376
20	3	10	Tape and reel	129377
4	3	100	Tube	129378
6	3	100	Tube	129379
8	3	100	Tube	129380
10	3	100	Tube	129381



2.54 mm Pin Headers

DUAL ROW, RIGHT ANGLE, THR —

No. of Pins	Mating Length (mm)	Mating Cycles (min.)	Packaging	Part Number
12	3	100	Tube	129382
14	3	100	Tube	129383
16	3	100	Tube	129384
18	3	100	Tube	129385
20	3	100	Tube	129386
4	3	100	Tape and reel	129387
6	3	100	Tape and reel	129388
8	3	100	Tape and reel	129389
10	3	100	Tape and reel	129390
12	3	100	Tape and reel	129391
14	3	100	Tape and reel	129392
16	3	100	Tape and reel	129393
18	3	100	Tape and reel	129394
20	3	100	Tape and reel	129395



2.54 mm Pin Headers

PART NUMBER INDEX —

Part Number	Page
129001	17
129002	17
129003	17
129004	17
129005	17
129006	17
129007	17
129008	17
129009	17
129010	17
129011	17
129012	17
129013	17
129014	17
129015	17
129016	17
129017	17
129018	17
129019	18
129020	18
129021	18
129022	18
129023	18
129024	18
129025	18
129026	18

Part Number	Page
129027	18
129028	18
129030	18
129031	18
129032	18
129033	18
129034	18
129035	18
129036	18
129037	18
129038	18
129039	18
129040	19
129041	19
129042	19
129043	19
129044	19
129045	19
129046	19
129047	19
129048	19
129049	19
129050	19
129051	19
129052	19
129053	19



2.54 mm Pin Headers

PART NUMBER INDEX —

Part Number	Page
129054	19
129055	19
129056	19
129057	19
129059	37
129060	37
129061	37
129062	37
129063	37
129064	37
129065	37
129066	37
129067	37
129068	37
129069	37
129070	37
129071	37
129072	37
129073	37
129074	37
129075	37
129076	37
129077	38
129078	38
129079	38
129080	38

Part Number	Page
129081	38
129082	38
129083	38
129084	38
129085	38
129086	38
129087	38
129088	38
129089	38
129090	38
129091	38
129092	38
129093	38
129094	38
129096	38
129097	38
129098	39
129099	39
129100	39
129101	39
129102	39
129103	39
129104	39
129105	39
129106	39
129107	39



2.54 mm Pin Headers

PART NUMBER INDEX —

Part Number	Page
129108	39
129109	39
129110	39
129111	39
129112	39
129113	39
129114	39
129115	39
129116	39
129117	39
129118	40
129119	40
129120	40
129121	40
129122	40
129123	40
129124	40
129125	40
129126	40
129127	40
129128	40
129129	40
129130	40
129131	40
129133	7
129134	7

Part Number	Page
129135	7
129136	7
129137	7
129138	7
129139	7
129140	7
129141	7
129142	7
129143	7
129144	7
129145	7
129146	7
129147	7
129148	7
129149	7
129150	7
129151	8
129152	8
129153	8
129154	8
129155	8
129156	8
129157	8
129158	8
129159	8
129160	8



2.54 mm Pin Headers

PART NUMBER INDEX

Part Number	Page
129162	8
129163	8
129164	8
129165	8
129166	8
129167	8
129168	8
129169	8
129170	8
129171	8
129172	9
129173	9
129174	9
129175	9
129176	9
129177	9
129178	9
129179	9
129180	9
129181	9
129182	9
129183	9
129184	9
129185	9
129186	9
129187	9

Part Number	Page
129188	9
129189	9
129191	25
129192	25
129193	25
129194	25
129195	25
129196	25
129197	25
129198	25
129199	25
129200	25
129201	25
129202	25
129203	25
129204	25
129205	25
129206	25
129207	25
129208	25
129209	26
129210	26
129211	26
129212	26
129213	26
129214	26



2.54 mm Pin Headers

PART NUMBER INDEX —

Part Number	Page
129215	26
129216	26
129217	26
129218	26
129219	26
129220	26
129221	26
129222	26
129223	26
129224	26
129225	26
129226	26
129228	26
129229	26
129230	27
129231	27
129232	27
129233	27
129234	27
129235	27
129236	27
129237	27
129238	27
129239	27
129240	27
129241	27

Part Number	Page
129242	27
129243	27
129244	27
129245	27
129246	27
129247	27
129248	27
129249	27
129250	28
129251	28
129252	28
129253	28
129254	28
129255	28
129256	28
129257	28
129258	28
129259	28
129260	28
129261	28
129262	28
129263	28
129265	21
129266	21
129267	21
129268	21



2.54 mm Pin Headers

PART NUMBER INDEX

Part Number	Page
129269	21
129270	21
129271	21
129272	21
129273	21
129274	21
129275	21
129276	21
129277	21
129278	21
129279	21
129280	21
129281	21
129282	21
129283	22
129284	22
129285	22
129286	22
129287	22
129288	22
129289	22
129290	22
129291	22
129292	22
129294	22
129295	22

Part Number	Page
129296	22
129297	22
129298	22
129299	22
129300	22
129301	22
129302	22
129303	22
129304	23
129305	23
129306	23
129307	23
129308	23
129309	23
129310	23
129311	23
129312	23
129313	23
129314	23
129315	23
129316	23
129317	23
129318	23
129319	23
129320	23
129321	23



2.54 mm Pin Headers

PART NUMBER INDEX

Part Number	Page
129323	42
129324	42
129325	42
129326	42
129327	42
129328	42
129329	42
129330	42
129331	42
129332	42
129333	42
129334	42
129335	42
129336	42
129337	42
129338	42
129339	42
129340	42
129341	43
129342	43
129343	43
129344	43
129345	43
129346	43
129347	43
129348	43

Part Number	Page
129349	43
129350	43
129351	43
129352	43
129353	43
129354	43
129355	43
129356	43
129357	43
129358	43
129360	43
129361	43
129362	44
129363	44
129364	44
129365	44
129366	44
129367	44
129368	44
129369	44
129370	44
129371	44
129372	44
129373	44
129374	44
129375	44



2.54 mm Pin Headers

PART NUMBER INDEX

Part Number	Page
129376	44
129377	44
129378	44
129379	44
129380	44
129381	44
129382	45
129383	45
129384	45
129385	45
129386	45
129387	45
129388	45
129389	45
129390	45
129391	45
129392	45
129393	45
129394	45
129395	45
129397	11
129398	11
129399	11
129400	11
129401	11
129402	11

Part Number	Page
129403	11
129404	11
129405	11
129406	11
129407	11
129408	11
129409	11
129410	11
129411	11
129412	11
129413	11
129414	11
129415	12
129416	12
129417	12
129418	12
129419	12
129420	12
129421	12
129422	12
129423	12
129424	12
129425	12
129426	12
129427	12
129428	12



2.54 mm Pin Headers

PART NUMBER INDEX

Part Number	Page	Part Number	Page
129429	12	129456	14
129430	12	129457	14
129431	12	129458	14
129432	12	129459	14
129433	12	129460	14
129434	12	129461	14
129435	13	129462	14
129436	13	129463	14
129437	13	129464	14
129438	13	129465	14
129440	13	129466	14
129441	13	129467	14
129442	13	129468	14
129443	13	129469	14
129444	13	129470	14
129445	13	129471	14
129446	13	129472	14
129447	13	129473	14
129448	13	129474	14
129449	13	129475	14
129450	13	129476	15
129451	13	129477	15
129452	13	129478	15
129453	13	129479	15
129454	13	129480	15
129455	13	129481	15



2.54 mm Pin Headers

PART NUMBER INDEX

Part Number	Page
129483	30
129484	30
129485	30
129486	30
129487	30
129488	30
129489	30
129490	30
129491	30
129492	30
129493	30
129494	30
129495	30
129496	30
129497	30
129498	30
129499	30
129500	30
129501	31
129502	31
129503	31
129504	31
129505	31
129506	31
129507	31
129508	31

Part Number	Page
129509	31
129510	31
129511	31
129512	31
129513	31
129514	31
129515	31
129516	31
129517	31
129518	31
129519	31
129520	31
129521	32
129522	32
129523	32
129524	32
129525	32
129526	32
129527	32
129528	32
129529	32
129530	32
129531	32
129532	32
129533	32
129534	32



2.54 mm Pin Headers

PART NUMBER INDEX

Part Number	Page
129535	32
129536	32
129538	32
129539	32
129540	32
129541	32
129542	33
129543	33
129544	33
129545	33
129546	33
129547	33
129548	33
129549	33
129550	33
129551	33
129552	33
129553	33
129554	33
129555	33
129556	33
129557	33
129558	33
129559	33
129560	33
129561	33

Part Number	Page
129562	34
129563	34
129564	34
129565	34
129566	34
129567	34
129568	34
129569	34
129570	34
129571	34
129572	34
129573	34
129574	34
129575	34
129576	34
129577	34
129578	34
129579	34
129580	34
129581	34
129582	35
129583	35
129584	35
129585	35
129586	35
129587	35



2.54 mm Pin Headers

PART NUMBER INDEX —

Part Number	Page
129588	35
129589	35

Part Number	Page
129590	35
129591	35



2.54 mm Pin Headers

THE ERNI-GROUP



OUR MANUFACTURING LOCATIONS



ERMEC, S.L. BARCELONA
C/ Francesc Teixidó, 22
08918 Badalona
(España)

Tel.: (+34) 902 450 160
Fax: (+34) 902 433 088
info@ermec.com
www.ermec.com

ERMEC, S.L. MADRID
c/Mejorada, 17,1ªPl.a.Of.D4
28850 Torrejón de Ardoz
(España)

PORTUGAL
portugal@ermec.com
BILBAO
bilbao@ermec.com



ERMEC, S.L. BARCELONA
C/ Francesc Teixidó, 22
08918 Badalona
(España)

Tel.: (+34) 902 450 160
Fax: (+34) 902 433 088
info@ermec.com
www.ermec.com

ERMEC, S.L. MADRID
c/Mejorada, 17,1ªPla.Of.D4
28850 Torrejón de Ardoz
(España)

PORTUGAL
portugal@ermec.com

BILBAO
bilbao@ermec.com

ERNI Electronics GmbH & Co. KG

Seestrasse 9
73099 Adelberg
Germany
Tel +49 7166 50-0
Fax +49 7166 50-282
info@erni.com
www.erni.com

Europe South America Africa Japan

ERNI Electronics, Inc.

2201 Westwood Ave
Richmond, VA 23230/USA
Tel +1 804 228-4100
Fax +1 804 228-4099
info@erni.us

North America Canada Mexico

ERNI Asia Holding Pte Ltd.

Blk 4008 Ang Mo Kio Avenue 10
#04-01/02 Techplace I
Singapore 569625
Tel +65 6 555 5885
Fax +65 6 555 5995
info@erni-asia.com

Asia Australia New Zealand



ERMEC, S.L. BARCELONA
C/ Francesc Teixidó, 22
08918 Badalona
(España)

Tel.: (+34) 902 450 160
Fax: (+34) 902 433 088
info@ermec.com
www.ermec.com

ERMEC, S.L. MADRID
c/Mejorada, 17, 1ªPl. Of. D4
28850 Torrejón de Ardoz
(España)

PORTUGAL
portugal@ermec.com
BILBAO
bilbao@ermec.com

© ERNI Electronics GmbH & Co. KG 2014 • Printed in Germany • A policy of continuous improvement is followed and the right to alter any published data without notice is reserved.

ERNI®, ERNI WoR&D®, Act. Connect. Perfect®, MicroCon®, MicroStac®, MicroSpeed®, MiniBridge®, MiniMez®, MaxiBridge®, ERmet®, ERmet ZD®, ERmet ZDplus®, ERmet ZD HD®, ERbic®, ERNIPRESS®, INTERact®, BLUEcontact® and WHITEspeed® are trademarks (registered or applied for in various countries) of ERNI Electronics GmbH & Co. KG.