

MSG series

Security caps for switch series 12000 - 3500 - 600H - 6000

Specifications



ERMEC, S.L. BARCELONA
C/ Francesc Teixidó, 22
08918 Badalona SPAIN

Tel. +34 902 450 160
info@ermec.com
www.ermec.com

ERMEC, S.L. - MADRID
C/ Puerto Rico, 4
28222 Majadahonda (Madrid) SPAIN

bilbao@ermec.com
portugal@ermec.com



- Robust
- For harsh environments
- Modern design

SPECIFICATIONS

- Operating temperature : -40°C to +85°C
- Storage temperature : -55°C to +85°C
- Salt spray : IEC 60068-2-11, test KA, 96 hours
- Mechanical life : 20.000 cycles

MATERIALS

- Support plate : matt black stainless steel
- Cap : thermoset

DIMENSIONS

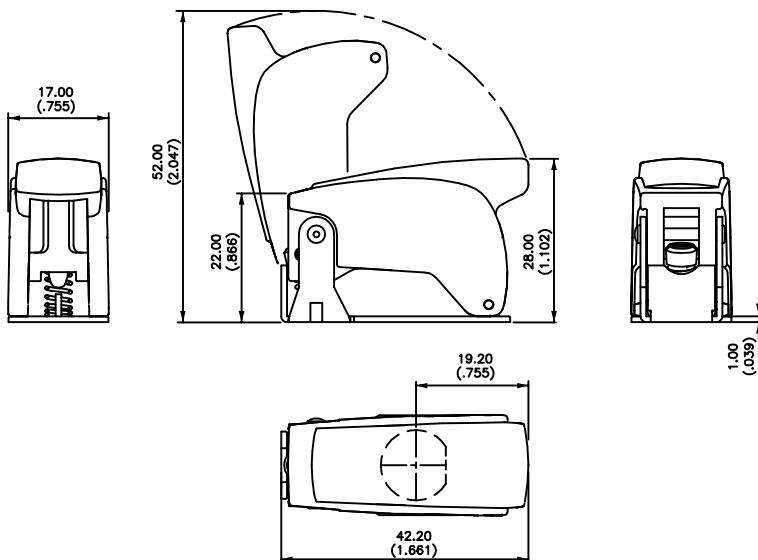

Note : Holes for wiring a seal are standard on all models.

MSG series

Security caps for switch series 12000 - 3500 - 600H - 6000

Overview

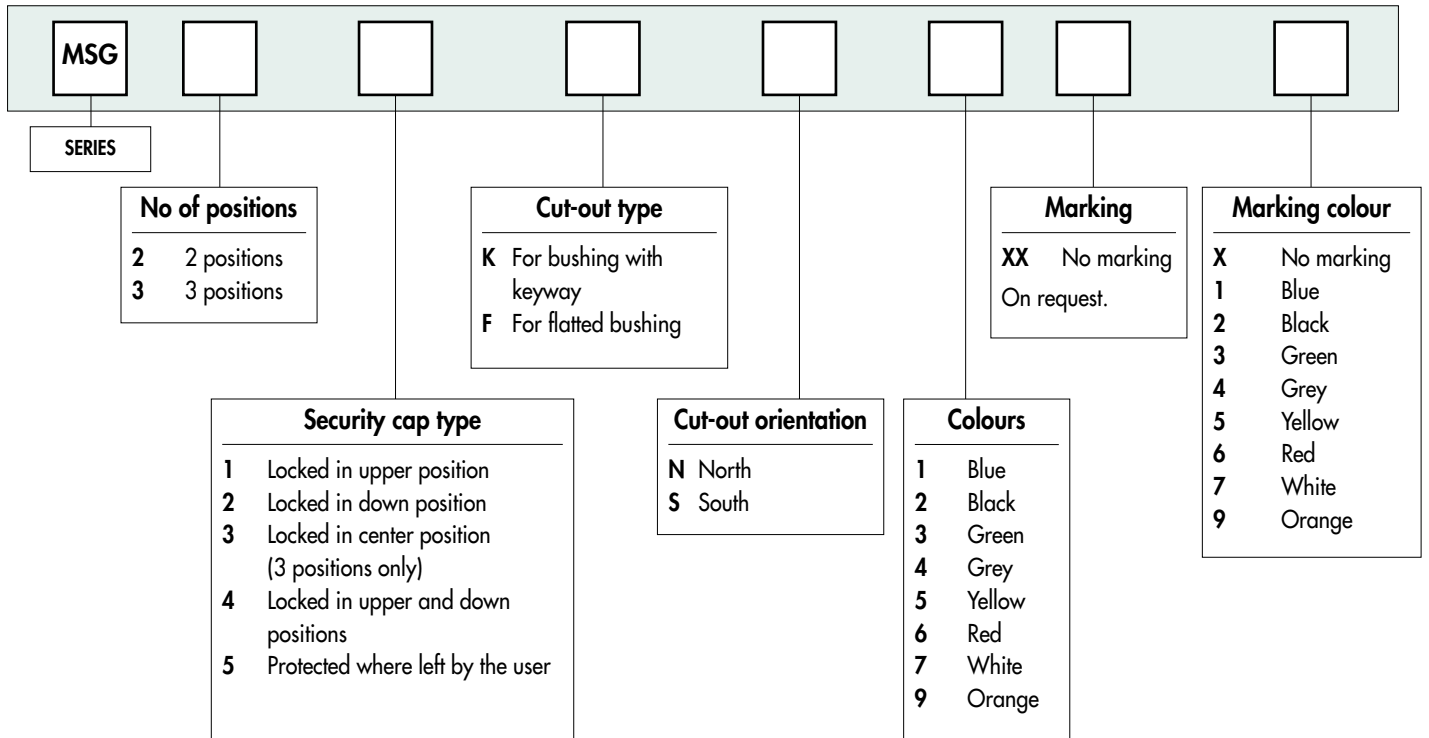

Dimensions : first dimensions are in mm while inches are shown as bracketed numbers.



NOTICE : please note that not all combinations of above numbers are available. Refer to the following pages for further information.



Mounting accessories : supplied with the switch or to order separately (see Section I)



Packaging unit : 40 pieces



ERMEC, S.L. BARCELONA
C/ Francesc Teixido, 22
08918 Badalona SPAIN

Tel. +34 902 450 160
info@ermec.com
www.ermec.com

ERMEC, S.L. - MADRID
C/ Puerto Rico, 4
28222 Majadahonda (Madrid) SPAIN

bilbao@ermec.com
portugal@ermec.com

MSG series

Security caps for switch series 12000 - 3500 - 600H - 6000

NUMBER OF POSITIONS

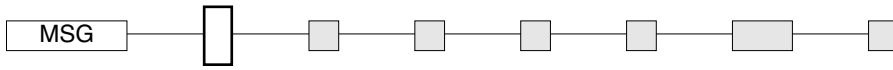

- 1 1 position
- 2 2 positions

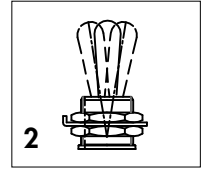
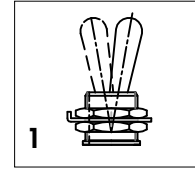

SECURITY CAP TYPE

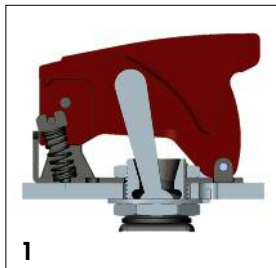
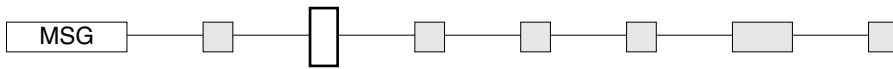

1 Locked in upper position

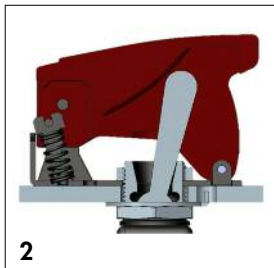

2 Locked in down position

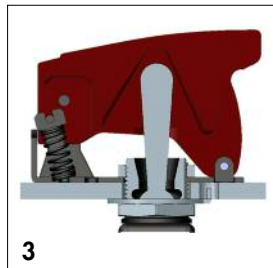

3 Locked in centre position
(3 positions only)

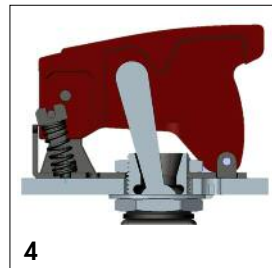

4 Locked in upper and
down positions

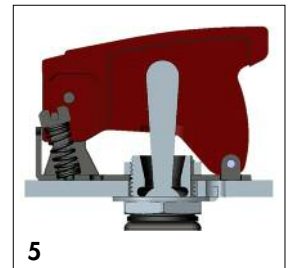

5 Protected where left
by the user

CUT-OUT TYPE

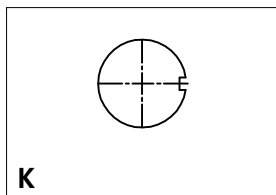
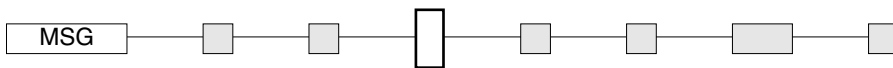

K For bushing with keyway

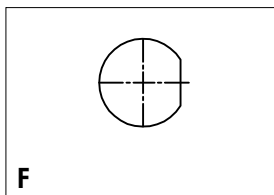

F For flatted bushing

CUT-OUT ORIENTATION

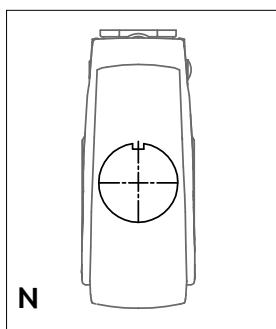
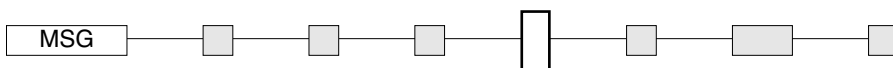

N

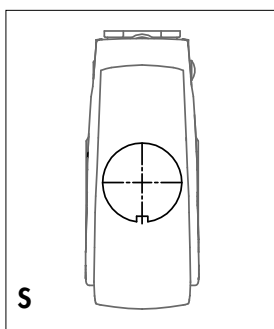

S

MSG series

Security caps for switch series 12000 - 3500 - 600H - 6000

COLOURS

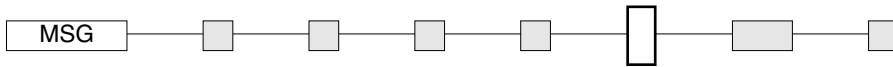

1 : blue - 2 : black - 3 : green - 4 : grey - 5 : yellow - 6 : red - 7 : white - 9 : orange

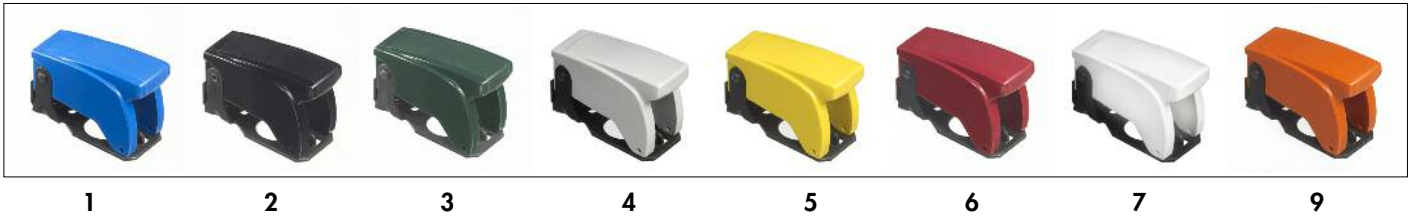

MARKING

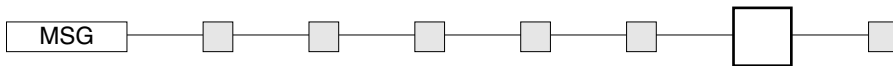

XX No marking

On request.

MARKING COLOUR

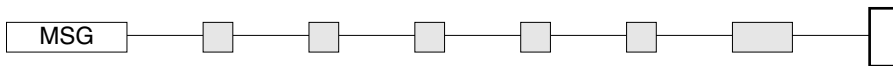

X No marking

1 : blue - 2 : black - 3 : green - 4 : grey - 5 : yellow - 6 : red - 7 : white - 9 : orange

MOUNTING



Standard



With K sealing option

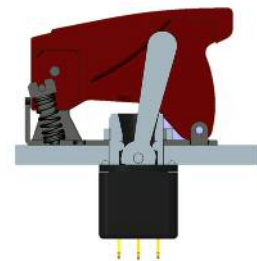

With X408 sealing option



ERMEC, S.L. BARCELONA
C/ Francesc Teixidó, 22
08918 Badalona SPAIN

Tel. +34 902 450 160
info@ermec.com
www.ermec.com

ERMEC, S.L. - MADRID
C/ Puerto Rico, 4
28222 Majadahonda (Madrid) SPAIN

bilbao@ermec.com
portugal@ermec.com

MSG1403-A