

FP series

Fully illuminated pushbutton switches •
bushing Ø 26 mm • momentary or latching



DISTINCTIVE FEATURES

- Snap-in mounting
- Full actuator or symbol illumination
- Large but lightweight
- Pad printed or laser etched symbols



ENVIRONMENTAL SPECIFICATIONS

- Front panel sealing : IP54 according to IEC 60529 with panel gasket and 2 mm panel thickness
- Operating temperature : -40 °C to +75 °C (-40 °F to +167°F)



ELECTRICAL SPECIFICATIONS

- Max. current/voltage rating with resistive load :
 - silver contacts (code 2) : 4 A 12 VDC
 - gold plated contacts (code 4) : 200 mA 12 VDC
- Initial contact resistance : 50 mΩ max.
- Insulation resistance : 1 GΩ min. at 500 VDC
- Dielectric strength : 1,000 Vrms 50 Hz min.
- Electrical life at full load :
 - Momentary models : 1 million cycles (gold plated contacts)
400,000 cycles (silver contacts)
 - Latching models : 200,000 cycles



GENERAL SPECIFICATIONS

- Panel thickness : 1.5 (.059) to 2 mm (.078) with panel gasket
2 (.078) to 2.5 mm (.885) without panel gasket.
- Total travel : 2.5 mm ± 0.5 mm
- Typical operating force : 8 N ± 2 N
- Low level or mechanical life :
 - Momentary models : 1 million cycles
 - Latching models : 200,000 cycles

The company reserves the right to change specifications without notice.



FP series

Fully illuminated pushbutton switches •
 bushing Ø 26 mm • momentary or latching



MATERIALS

- Case : PA46
- Actuator : PA12
- Bushing/ bezel : ABS
- Contacts : silver (code 2) or silver, gold plated (code 4)

APEM products may be recycled at end-of-life for the re-claiming of valuable metal components.



PANEL CUT-OUT

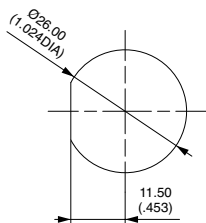

WIRING DIAGRAM

→ FLAT

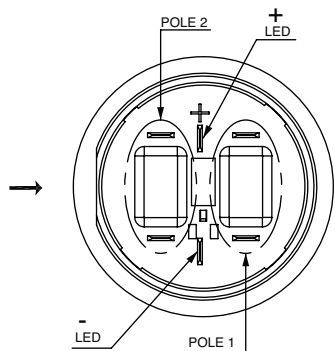

FP series

Fully illuminated pushbutton switches •
bushing Ø 26 mm • momentary or latching



BUILD YOUR PART NUMBER

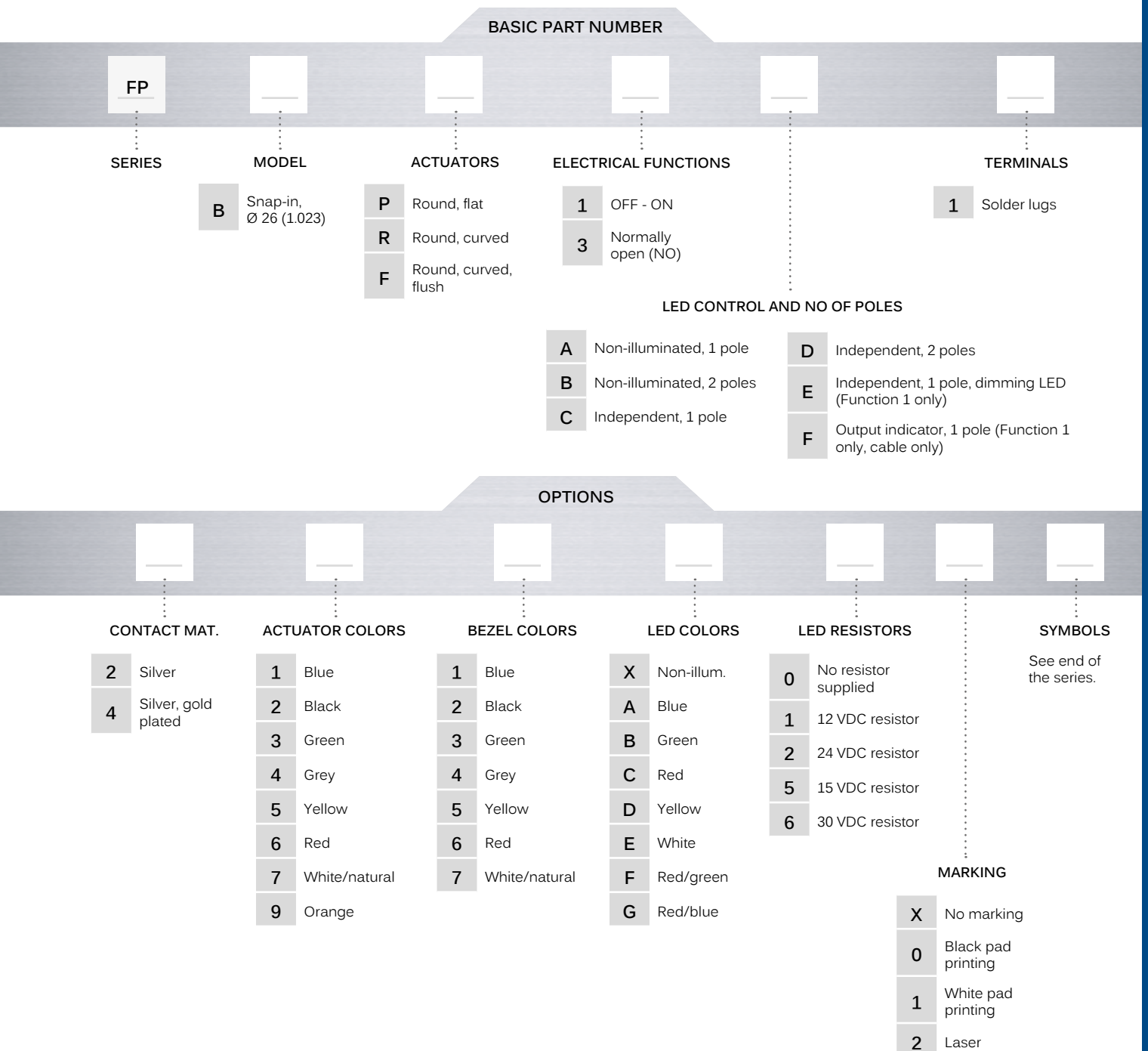

ABOUT THIS SERIES

On the following pages, you will find successively basic part numbers of switches and options in the same order as in above chart.



Notice : please note that not all combinations of above numbers are available. Refer to the following pages for further information.



Mounting accessories : Standard hardware supplied : 1 hex nut and 1 panel gasket.

FP series

Fully illuminated pushbutton switches •
bushing Ø 26 mm • momentary or latching

SOLDER LUG TERMINALS



	LATCHING			
Curved actuator	FPBR1•1	OFF	ON	
Flat actuator	FPBP1•1	OFF	ON	
	MOMENTARY (NO)			
Curved actuator	FPBR3•1			
Flat actuator	FPBP3•1			

→ FLAT

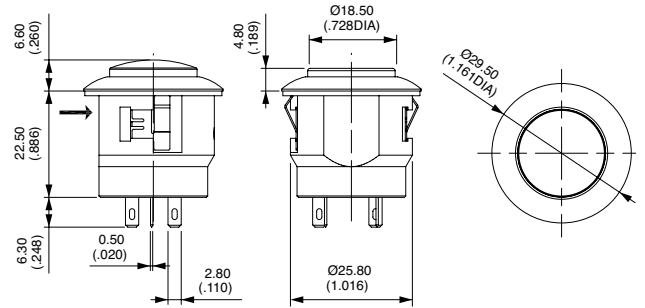

LED CONTROL AND NUMBER OF POLES

Complete the model numbers on previous pages with one of the following codes.

	Function 1 (latching)	Function 3 (momentary)
Non-illuminated one pole A		
Non-illuminated two poles B		
Independent one pole C		
Independent two poles D		
Independent one pole Dimming LED E		-
Output indicator, one pole Cable only F		-

dotted line = jumper to be wired by the user. LED- has to be wired to one pin of pole 2.

FP series

Fully illuminated pushbutton switches •
bushing Ø 26 mm • momentary or latching

CONTACT MATERIALS

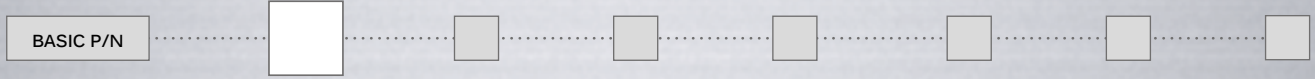

- 2 Silver
- 4 Silver, gold plated

ACTUATOR COLORS

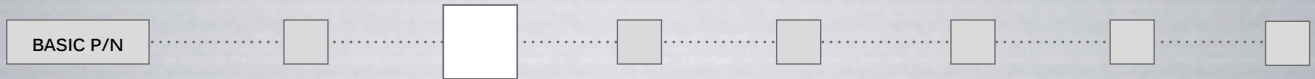

- 1 Blue
- 2 Black
- 3 Green
- 4 Grey
- 5 Yellow
- 6 Red
- 7 White/natural
- 9 Orange

BEZEL COLORS



- 1 Blue
- 2 Black
- 3 Green
- 4 Grey
- 5 Yellow
- 6 Red
- 7 White/natural

LED COLORS



- X Non-illuminated
- A Blue
- B Green
- C Red
- D Yellow
- F Red/green
- G Red/blue

LED RESISTOR

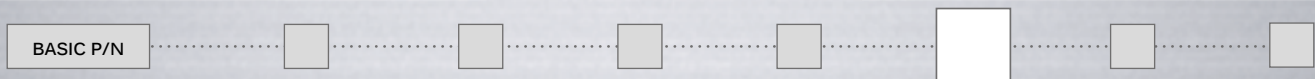

- 0 No resistor supplied
- 1 12 VDC resistor
- 2 24 VDC resistor
- 5 15 VDC resistor
- 6 30 VDC resistor

FP series

Fully illuminated pushbutton switches •
bushing Ø 26 mm • momentary or latching

MARKING

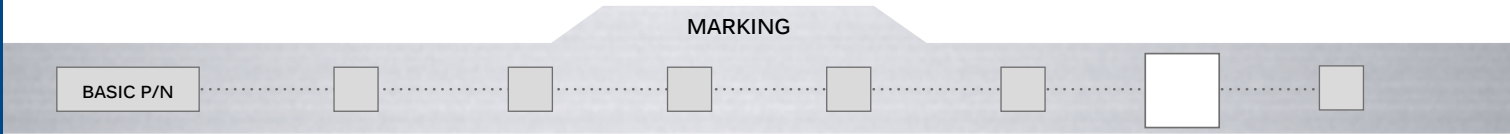

- X No marking
- 0 Black pad printing
- 1 White pad printing
- 2 Laser

SYMBOLS

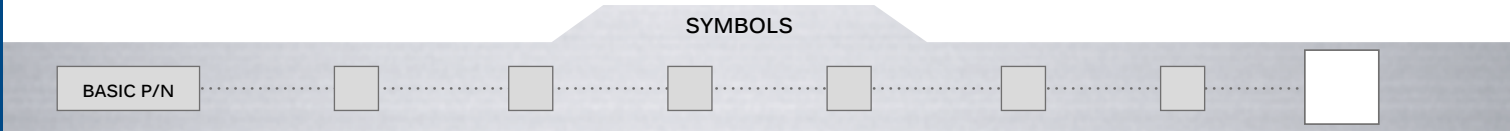

Blank No symbol

Available symbols

Complete the enlarged box with the one of the codes listed on the following pages.

Marking color

White marking for illuminated actuators (laser etching) and non-illuminated black actuators (pad printing). Black marking for non-illuminated color actuators (pad printing). Other : on request.

Marking area

The symbol will be included in the hatched area.

MARKING AREA

→ FLAT

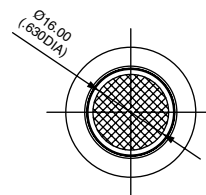

FP range

Symbols for fully illuminated pushbutton switches



Most symbols meet the ISO 7000 standard “graphical symbols for use on equipment” (code given in bracket in the description).

Contact us for symbols not featured in the following tables.

















CODE	SYMBOL	DESCRIPTION	CODE	SYMBOL	DESCRIPTION	CODE	SYMBOL	DESCRIPTION
XX	None	-	16		Revolving light	32		Emergency first aid vehicle (2565)
01	ON	-	17		Rear ventilator	33		Load tipping (1557)
02	OFF	-	18		Heating (0637)	34		Loading light (2457)
03	O	-	19		Door opening	35		Tractor, rear-ward (1667)
04	I	-	20		Windshield demister/defroster (0635)	36		Combine, direction of movement (1678)
05	II	-	21		Windshield wiper (0086)	37		Use no forks (2406)
06	STOP	-	22		Windshield washer (0088)	38		Transmission (1166)
07	A	Stop	23		Ventilator fan (0089)	39		Working spot light (1145)
08	M	Motion	24		Side mirror defroster	40		Engine (0640)
09		Up motion	25		Restarting pump	41		Horn (0244)
10		Down motion	26		Front fog lights (0633)	42		Lock (1656)
11		Hot	27		Rear fog lights (0634)	43		Taxi sign light (2551)
12		Cold	28		Propulsion system trim	44		Working light (1204)
13		Hazard warning (0085)	29		Beacon (1141)	45		Working light symmetric (1204)
14		Traveller lighting	30		Anchor	46		-
15		Driver lighting (1421)	31		Electric motor (0011)	47	ASM	-





FP range

Symbols for fully illuminated pushbutton switches

CODE	SYMBOL	DESCRIPTION	CODE	SYMBOL	DESCRIPTION	CODE	SYMBOL	DESCRIPTION
48		All wheel drive	69		Engine idle control	90		ECAS reset
49		Differential lock (1662)	70		Cruise res/set	91		Driver windows heating
50		-	71		Driver windows up/down	92		Cruise set
51		-	72		Middle door opening	93		Air bag up/down
52		-	73		Front door opening	94		Read lighting
53		-	74		Lighting in baggage room	95		Lighting main switch
54		Rear window wiper (0097)	75		Cruise on/off	96		Heating using water
55		Rear window washer (0099)	76		TV	97		Low beam
56		Lower load (2223)	77		Pump	98		Position lights
57		Cab lock (1560)	78		Toilet	99		Diesel acceleration
58		Extraction	79		Toilet decontamination	A1		Manual mode
59		Pumping in	80		Front windshield heating	A2		Clockwise cabin rotation
60		Rear PTO (1572)	81		Aus	A3		Anticlockwise cabin rotation
61		Front PTO	82		Radiator fan	A4		-
62		Rockshaft down	83		Remove retarder	A5		-
63		Rockshaft up	84		Restricted speed	A6		Parking brake
64		Indicator	85		Preheater	A7		-
65		Brake release	86		ABS detection	A8		-
66		Baggage room left door	87		ECAS detection	A9		-
67		Baggage room right door	88		Engine stop	AA		-
68		Power blinds	89		Cruise res/cancel	AB		-

Symbols for fully illuminated pushbutton switches

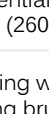
CODE	SYMBOL	DESCRIPTION
AC		-
AD		-
AE		-
AF		-
AG		Battery charging condition (0247)
AH		Turn signals (0084)
AJ		High beam (0082)
AK		Differential lock, bogie (2600)
AL		Brushing with a rotating brush (0070)
AM		Differential lock, transfer case 4x4 (2475)
AN		Loader bucket, float (1441)
AP		Loader bucket (1437)
AQ		Rear window washer & wiper (0098)
AR		Header, Header drive (1579)
AS		Excavator/backhoe boom side shift (2091)
AT		Chemical water treatment (1851)
AU		Grapple skidder, single funct° boom (1762)

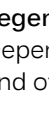
CODE	SYMBOL	DESCRIPTION
AV		-
AW		-
AY		-
AZ		-
B1	HIGH	-
B2	LOW	-
B3		-

Legend scale

Depending on space available on the product (see "Symbols" section at the end of each series).