

PR series

Stainless steel keypads with round keys



DISTINCTIVE FEATURES

- Recessed, flush or raised key according to panel thickness
- Rear or front mounting
- Compact version: 14 mm round keys
- Panel sealed to IP65
- Custom markings on request



ENVIRONMENTAL SPECIFICATIONS

- Front sealing : IP65 according to DIN 40050-9
- Operating temperature : -20 °C to +70 °C (-4 °F to +158 °F)
- Storage temperature : -40 °C to +85 °C (-40 °F to +185 °F)
- Impact resistance : IK07 according to EN 50102
- Flame resistance : UL94 HB horizontal position (30 seconds max).
- Salt spray : 96 hours according to IEC 512-6, test 11f
- Washable : most commonly used detergents and solvents



ELECTRICAL SPECIFICATIONS

- Output type : matrix (NO contacts)
- Max. current/voltage rating with resistive load : 50 mA at 12 VDC
- Initial contact resistance ON : 10Ω max.
- Insulation resistance : 1GΩ min. at 500 VDC
- LED backlight : 12 VDC (standard version)



GENERAL SPECIFICATIONS

- Contact force : 4 N ± 0.5 N (non-illuminated version)
3.5 N (illuminated version)
- Stroke : 0.5 mm (.019)
- Low level or mechanical life : 1 million cycles
- Panel thickness : 2 mm (.078) (standard version)
- Connection : male connector

The company reserves the right to change specifications without notice.

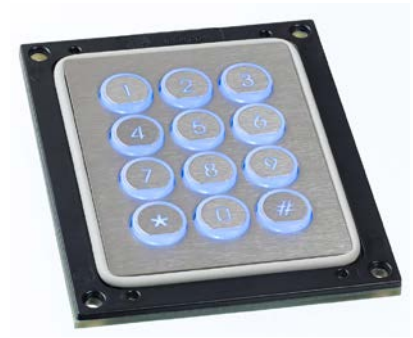

PR series

Stainless steel keypads with round keys



MATERIALS

- Keytops : 316L stainless steel
- Keys : ABS or PA6 nylon (illuminated versions)
- Key holders : ABS UL VO
- Frame : 304 stainless steel
- PCB : FR4
- Seal : 0.4 mm thick silicone
- Actuator : stainless steel snap domes AISI 304
- Contacts : gold plated

APEM products may be recycled at end-of-life for the re-claiming of valuable metal components.



BUILD YOUR PART NUMBER

BASIC PART NUMBER



MODELS

PRO	Ø 14 (.551) round keys
PRR	Ø 14 (.551) round keys, smaller PCB size
PRN	Ø 14 (.551) round keys, navigator layout, 4 or 5 keys



NO OF KEYS

01	1 key
04	4 keys
05	5 keys
12	12 keys
16	16 keys



FRAME

0	No frame
1	With frame, rear mounting (not available on 1-key models)
2	With frame, front mounting (only 12-key PRR models)



ILLUMINATION

0	Non-illuminated
L	Illuminated

OPTIONS



LED COLORS

XX	No LED
0R	Red
0B	Blue
0G	Green
0Y	Yellow



VOLTAGE

XX	Without
05	5 VDC
12	12 VDC
24	24 VDC



MARKING

0	Blank keys
S	Standard marking
C	Custom marking



ABOUT THIS SERIES

Some configurations are shown on the following pages. Other drawings are available on request.

Notice : please note that not all combinations of above numbers are available. Refer to the following pages for further information.

PR series

Stainless steel keypads with round keys

SINGLE KEY MODEL - NON-ILLUMINATED



PR00100

Customer Panel CUT-OUT Ø 14.5 mm

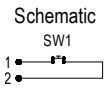
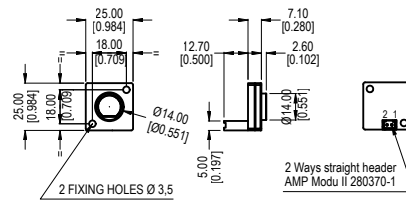

SINGLE KEY MODEL - ILLUMINATED



PR0010L

Customer Panel CUT-OUT Ø 14.5 mm

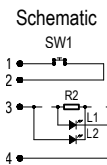
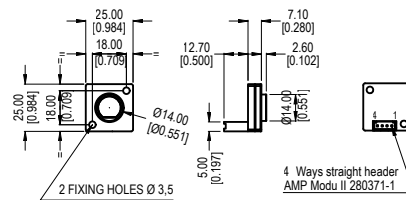

4-KEY MODEL - NON-ILLUMINATED



PR00400

Customer panel CUT-OUT: (Panel thickness from 1,5 to 2,5 mm) n. 4 holes diam 14,5 +0,1/-0 mm

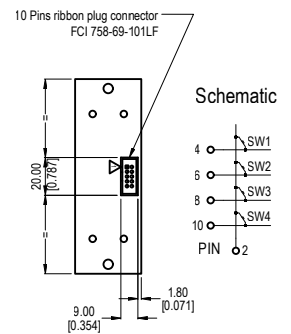
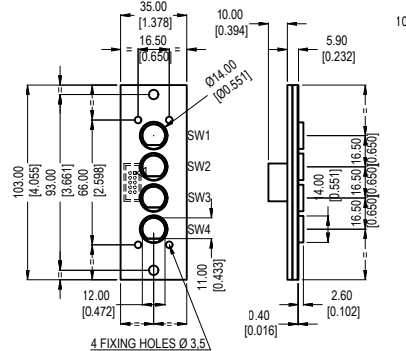

4-KEY MODEL - ILLUMINATED



PR0040L

Customer panel CUT-OUT: (Panel thickness from 1,5 to 2,5 mm) n. 4 holes diam 14,5 +0,1/-0 mm

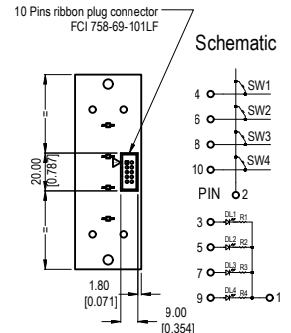
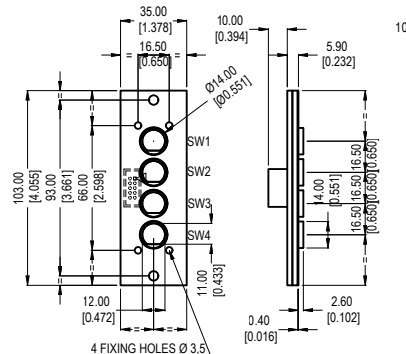

PR series

Stainless steel keypads with round keys

12-KEY MODEL - ILLUMINATED



PR0120L

12-KEY MODEL - WITH FRAME REAR MOUNTING - NON ILLUMINATED



PR01210

12-KEY MODEL - WITH FRAME REAR MOUNTING - ILLUMINATED



PR0121L

12-KEY MODEL - WITH FRAME SMALLER PCB SIZE - NON ILLUMINATED



PRR1220

Customer panel CUT-OUT: (Panel thickness from 1,5 to 2,5 mm) n. 12 holes Ø 14,50 mm +/-0,-10

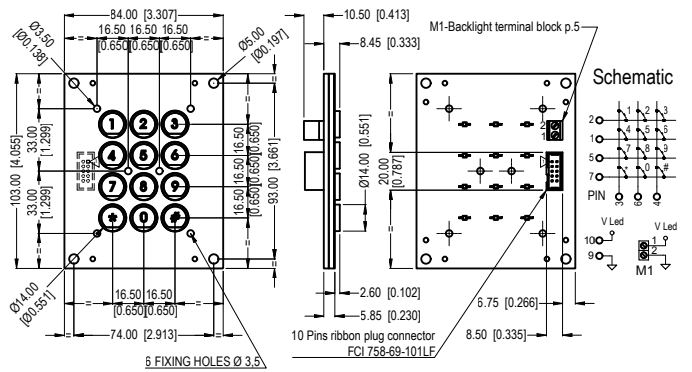

Customer panel CUT-OUT: (Panel thickness from 1,5 to 2,0 mm) 63,5 x 82,5 x R2,25 mm +/-0,-1

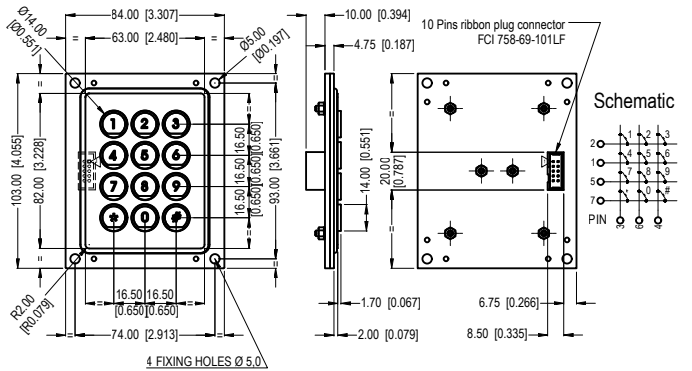

Customer panel CUT-OUT: (Panel thickness from 1,5 to 2,0 mm) 63,5 x 82,5 x R2,25 mm +/-0,-1

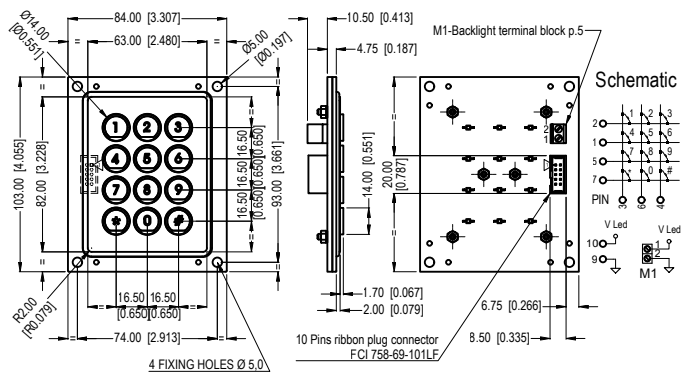

Customer Panel Cut-Out 58.5 x 75 x R=3.5 mm

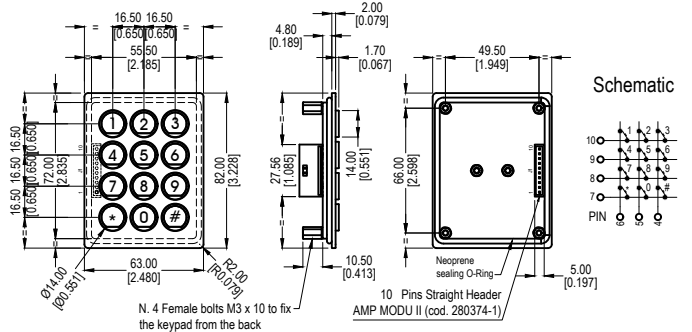

12-KEY MODEL - WITH FRAME SMALLER PCB SIZE - ILLUMINATED



PRR122L

12-KEY MODEL - SMALLER PCB SIZE NON ILLUMINATED



PRR1200

12-KEY MODEL - SMALLER PCB SIZE ILLUMINATED



PRR120L

16-KEY MODEL - NON ILLUMINATED



PR01600

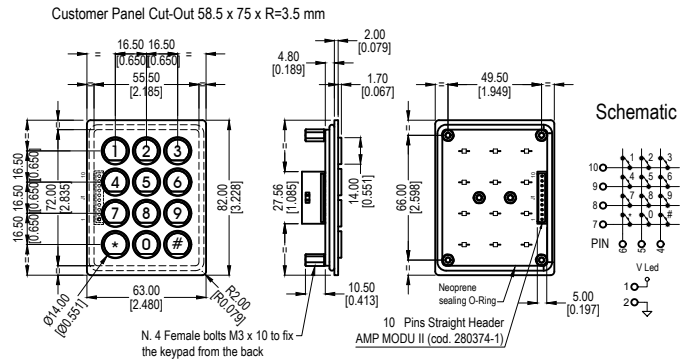

Customer panel CUT-OUT: (Panel thickness from 1,5 to 2,5 mm) n. 12 holes Ø 14,50 mm +0.1/-0

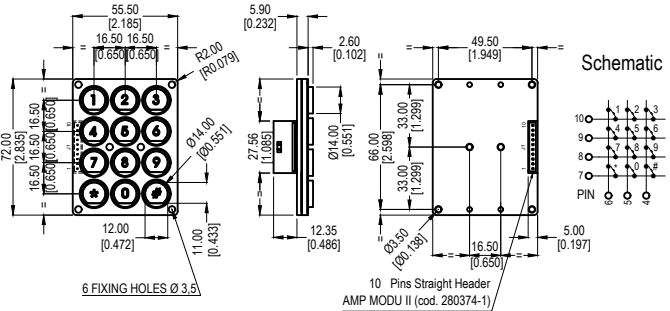

Customer panel CUT-OUT: (Panel thickness from 1,5 to 2,5 mm) n. 12 holes Ø 14,50 mm +0.1/-0

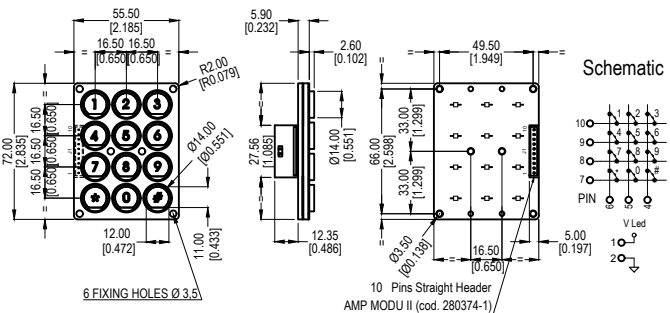

Customer panel CUT-OUT: (Panel thickness from 1,5 to 2,5 mm) n. 16 holes Ø 14,50 mm +0.1/-0

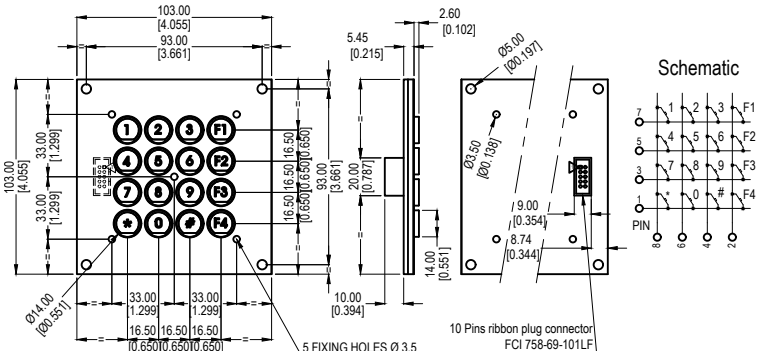

PR series

Stainless steel keypads with round keys

16-KEY MODEL - ILLUMINATED

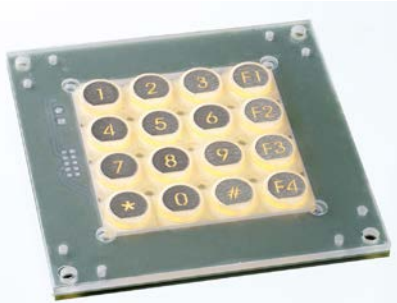

PR0160L

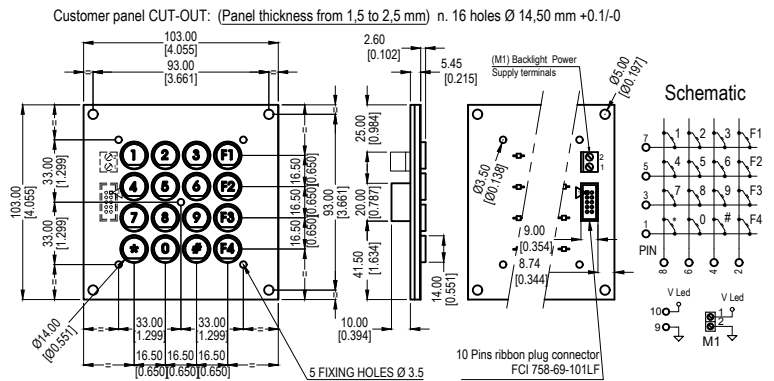

16-KEY MODEL - WITH FRAME REAR MOUNTING - NON ILLUMINATED



PR01610

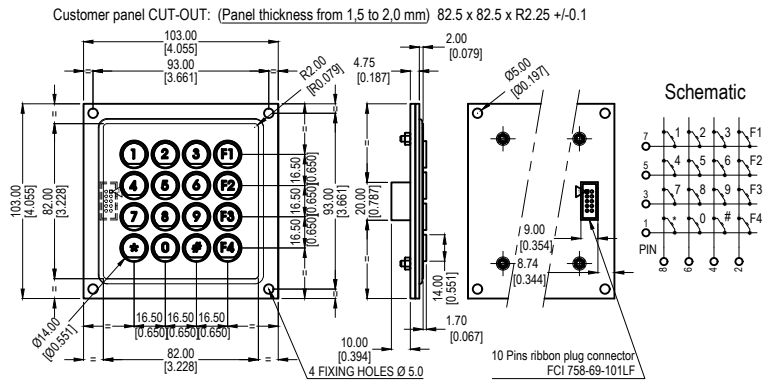

16-KEY MODEL - WITH FRAME REAR MOUNTING - ILLUMINATED



PR0161L

