

# PIC

SWITCHING THE SMART WAY

Reed Switches

SMD Reed Switches

Reed Sensors

Level Sensors

Hall Sensors

Magnets

## Sensor Technology



Distribución de componentes  
eléctricos y electrónicos

Tel.: (+34) 902 450 160

Fax: (+34) 902 433 088

[ermec@ermec.com](mailto:ermec@ermec.com)

[www.ermec.com](http://www.ermec.com)



ERMEC, S.L. BARCELONA  
C/ Francesc Teixidó, 22  
08918 Badalona  
(España)

Tel.: (+34) 902 450 160  
Fax: (+34) 902 433 088  
[info@ermec.com](mailto:info@ermec.com)  
[www.ermec.com](http://www.ermec.com)

ERMEC, S.L. MADRID  
c/Mejorada, 17,1ªPl. Of.D4  
28850 Torrejón de Ardoz  
(España)

PORTUGAL  
[portugal@ermec.com](mailto:portugal@ermec.com)  
BILBAO  
[bilbao@ermec.com](mailto:bilbao@ermec.com)

## Welcome to PIC



Our work is never done.  
Passion, respect, integrity and  
discipline are the four core values  
which drive us to sophisticated  
products and continuous growth  
in a globalized world.

# P

Product Innovation

# I

Intelligent Design

# C

Creative Manufacturing



ERMEC, S.L. BARCELONA  
C/ Francesc Teixidó, 22  
08918 Badalona  
(España)

Tel.: (+34) 902 450 160  
Fax: (+34) 902 433 088  
[info@ermec.com](mailto:info@ermec.com)  
[www.ermec.com](http://www.ermec.com)

ERMEC, S.L. MADRID  
c/Mejorada, 17, 1ªPl.OF.D4  
28850 Torrejón de Ardoz  
(España)

PORTUGAL  
[portugal@ermec.com](mailto:portugal@ermec.com)  
BILBAO  
[bilbao@ermec.com](mailto:bilbao@ermec.com)



## Innovation

Modern machinery, perfected production concepts, clear information policy and our comprehensive sensor know-how secure our premier position in the branch.

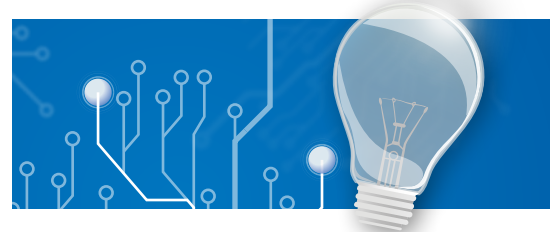

## Quality

Continuous optimization in the areas of research, development, production, service and marketing assure high standards in product quality.



## Sustainability

Sustainability is an essential part of our philosophy. Careful use of resources and environmental compatibility starts long before production and does not finish at sale. We remain true to this principle with regard to social and economic aspects.

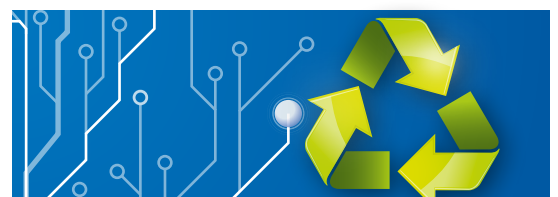

# Table of Contents

5-7	<b>Reed Switches</b>		Reed Switch Basics .....5 Micro / Standard .....6 Power / Special .....7
8-12	<b>SMD Reed Switches</b>		S-Series .....8 T-Series .....9 Z-Series .....10 TH-Series .....11 PRX+2-Series .....12
13-21	<b>Reed Sensors</b>		Reed Sensor Basics .....13 Snap-fit .....14 Flatpack ..... 15-16 Through Hole .....17 Tubular .....18 Tubular Threaded ..... 19-20 Press-fit ..... 21
22-27	<b>Level Sensors</b>		Level Sensor Basics ..... 22 PLS-PP-Series ..... 23-24 PLS-PA-Series ..... 25 PLS-VA-Series ..... 26 PLS-PP Horizontal ..... 27
28-31	<b>Hall Sensors</b>		Hall Sensor Basics ..... 28 Flatpack ..... 29 Tubular Threaded ..... 30 Flange Mount ..... 31
32-34	<b>Magnets</b>		Actuators ..... 32-33 Magnet Selector ..... 34
35	<b>Customized Products</b>		Connectors and cable assemblies ..... 35 Special housings ..... 35 PCB-Assemblies ..... 35 Customized Level Sensors ..... 35 Magnets ..... 35
36-38	<b>Tech Center</b>		Reed Switches: How to operate ..... 36 Reed Switches: Precautions ..... 37 Housing Materials: Chemical resistance chart ..... 38
39	<b>Contact</b>		

# Reed Switch Basics

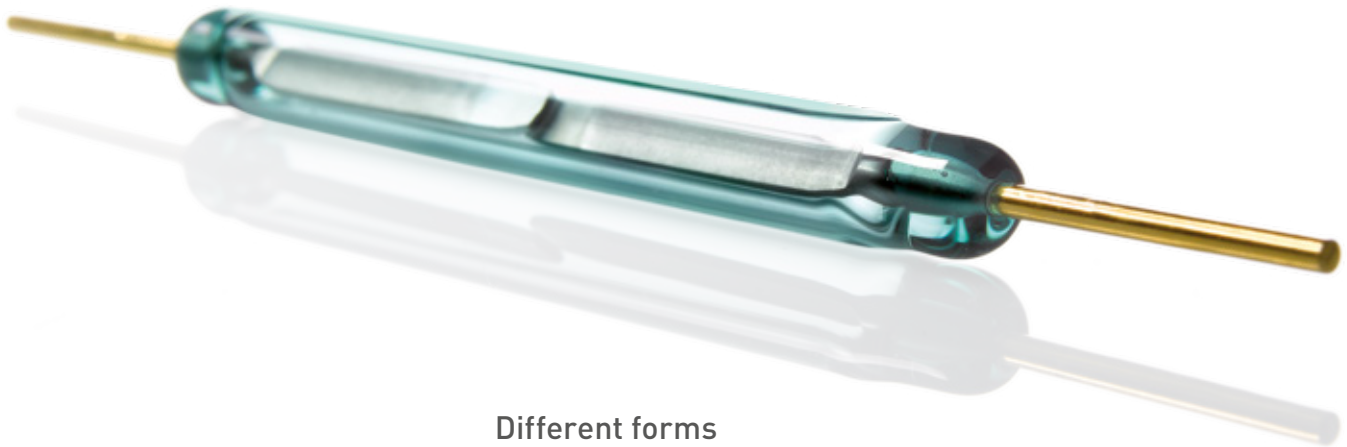

## Different forms

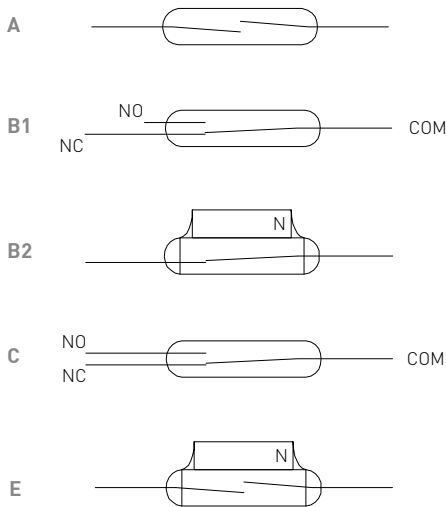

### Form A

Normally open, Reed Switch will close contact in presence of a magnet.

### Form B

Normally closed. Either achieved by using a Form C switch with the NO wire cut off or by using an attached magnet (requires pole oriented actuation).

### Form C

Change over, Reed Switch will change from NC to NO contact in presence of a magnet.

### Form E

Latching type. Switching status remains stable after a magnetic field disappears until a magnet with opposite polarity approaches.

## How does a Reed Switch work?

A Reed Switch consists of a pair of ferromagnetic reeds, hermetically sealed in a glass tube. Their free ends overlap at a very small distance.

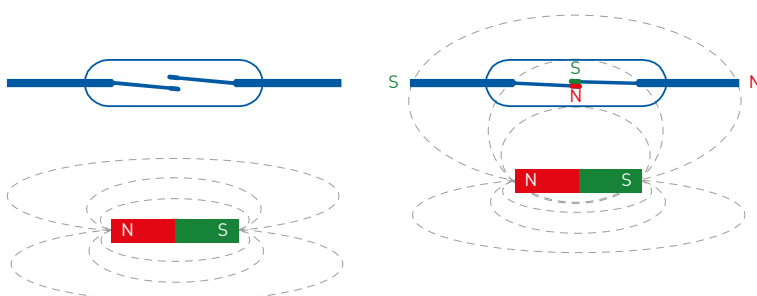

## Benefits

- > No power supply required
- > Contacts hermetically sealed
- > Most economic non-touch switching solution
- > Not ESD sensitive
- > Various methods of actuation possible
- > Magnetic and electrical pole independent
- > Non-touch actuation permits smooth surfaces and modern design
- > Various sensitivity ranges available

## Applications



## Features

- > PMC-0701 for limited space the 7 mm glass length offers best solution
- > PMC-1401 most cost-efficient general purpose switch using 14 mm glass length
- > Close differential and mains voltage types available

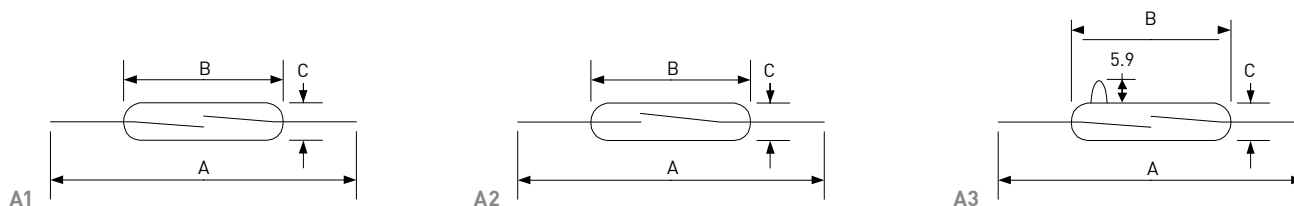
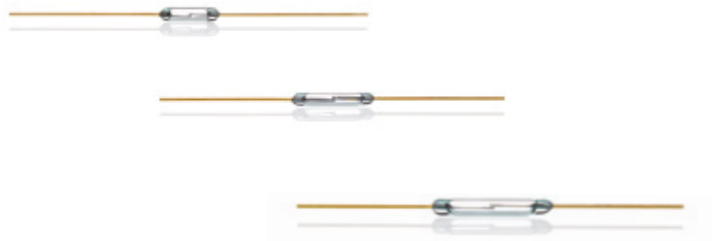

		Micro Switches				Standard Switches						
		HSR-0025	HSR-0035RT	PMC-0701	HSR-502	PMC-1001	PMC-1401	PMC-1402 DO min. 60%!	PMC-2003 DO max. 60%!	PMC-1515 Mains Voltage	PMC-1496	TRH-200
<b>Dimensions</b>												
A = Total length nom.	mm	26.7	26.7	41.5	37.9	41.5	44.0	44.3	45.6	40.4	55.0	52.5
B = Glass length max.	mm	4.32	5.08	7.0	8.0	10.0	14.2	14.0	21.0	15.3	14.5	14.8
C = Glass diameter max.	mm	0.97x1.27	1.4	1.8	2.4	1.8	2.3	2.3	3.0	2.3	2.2	2.7
Contact arrangement (figure)		A2	A2	A1	C2	A1	A1	A1	A1	A1	C2	C2
<b>Characteristics</b>												
Contact form		A	A	A	C	A	A	A	A	A	C	C
Contact rating max.	W / VA	0.25	1	10	3	10	10	10	10	10	20	5
Switching voltage max.	VDC	30	30	150	30	180	200	200	180	200	150	175
	VAC	20	30	120	30	130	140	140	130	260	140	120
Switching current max.	A	0.01	0.05	0.5	0.1	0.7	1	0.5	1	0.3	1	0.25
Carry current max.	A	0.7	1	0.7	1	1	1.2	1	2	1.4	2	1.5
Breakdown voltage min.	VDC	80	200	200	200	200	240	250	250	400	200	200
Contact resistance [initial] max.	mΩ	750	750	200	200	150	100	100	150	100	150	100
<b>Performance</b>												
Pull in range available	AT	2-15	5-20	10-20	15-35	10-25	10-30	10-20	30-50	20-30	15-30	15-30
Drop out min.	AT	1	3	4	5	4	5	60% of PI	30% of PI	4	6	5
<b>Environmental</b>												
Switching frequency max.	Hz	900	700	600	100	500	500	500	400	400	100	100
Vibration (50-2000 Hz)	g	15	15	10	30	20	20	30	20	30	30	30
Shock (1/2 sin 11 ms)	g	75	75	50	50	100	100	100	50	100	50	50
Operating Temperature	°C	-40 to +125					-60 to +155	-40 to +125		-20 to +125	-40 to +130	-40 to +125
UL / CSA / RoHS		--/--/•	--/--/•	•/•/•	--/--/•	•/•/•	•/•/•	•/•/•	•/•/•	•/•/•	--/--/•	--/--/•

AT ranges and characteristics stated for unmodified Reed Switches.  
Pls. refer page 36/37 for additional technical information. All dimensions in mm. Subject to change without prior notice.

## Features

- > Switching voltage up to 10 kV
- > Carry current up to 5 A
- > Contact rating max. 250 Watts
- > Normally open, change over and latching types

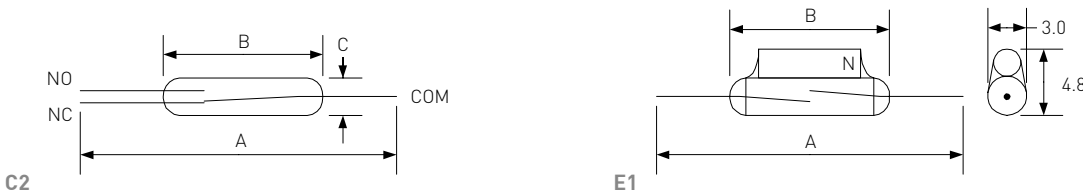
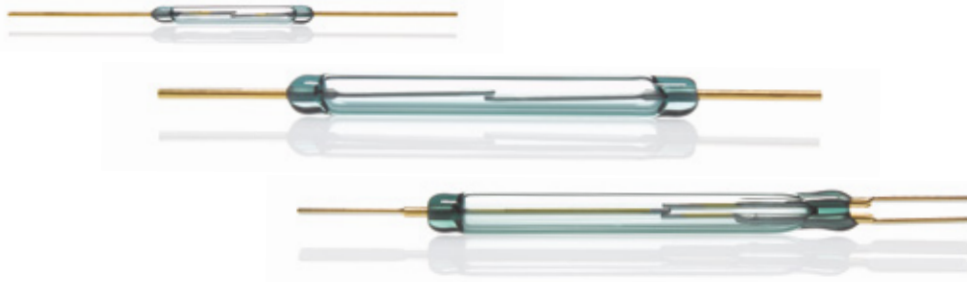

		Power Switches							Special Switches			
									High voltage			Latching
		PMC-2021	PMC-3617	PMC-5001	PMC-5002	CRH-500	PMC-5025	HSR-834WT	HSR-V7K	HSR-V10K	HSR-V15K	PMC-1401X
<b>Dimensions</b>												
A = Total length nom.	mm	55.0	70.0	80.0	80.0	85.7	80.0	86.0	82.0	82.0	82.0	44.0
B = Glass length max.	mm	20.0	36.0	50.0	50.0	39.7	52.0	34.3	53.4	53.4	53.4	14.2
C = Glass diameter max.	mm	2.54	5.6	5.4	5.4	5.4	5.6	5.33	5.4	5.4	5.4	
Contact arrangement [figure]		A1	C2	A1	A1	C2	C2	C2	A3	A3	A3	E1
<b>Characteristics</b>												
Contact form		A	C	A	A	C	C	C	A	A	A	E
Contact rating max.	W / VA	50	60	120	250	60	60	100	50	50	50	5
Switching voltage max.	VDC	200	400	250	250	500	230	500	4000	5000	6000	140
	VAC	250	400	250	250	350	230	500	2800	3500	4200	100
Switching current max.	A	1.5	1	3	5	1	1	3	3	3	3	0.5
Carry current max.	A	2	2	3	5	3	2	3	4.5	4.5	4.5	0.7
Breakdown voltage min.	VDC	400	1000	700	700	1200	400	1000	7000	10000	15000	200
Contact resistance [initial] max.	mΩ	100	100	200	200	130	100	500	150	150	150	150
<b>Performance</b>												
Pull in range available	AT	25-40	50-80	50-90	50-100	50-80	80-120	60-100	60-125	100-150	130-170	
Drop out min.	AT	5	20	20	15	15	20	30	20	30	40	
<b>Environmental</b>												
Switching frequency max.	Hz	300	100	25	5	50	100	50	50	50	50	500
Vibration (50-2000 Hz)	g	20	35 <sup>1)</sup>	10 <sup>2)</sup>	10 <sup>2)</sup>	15	35 <sup>1)</sup>	15	30	30	30	10
Shock (1/2 sin 11 ms)	g	50	50	150 <sup>3)</sup>	150 <sup>3)</sup>	10	50	10	100	100	100	50
Operating Temperature	°C	-60 to +125	-40 to +125	-60 to +130	-60 to +100	-20 to +125	-40 to +125	-25 to +125	-60 to +125			-40 to +125
UL / CSA / RoHS		•/•/•	--/--/•	•/•/•	•/•/•	--/--/•	--/--/•	•/•/•	--/--/•	--/--/•	--/--/•	--/--/•

AT ranges and characteristics stated for unmodified Reed Switches.  
Pls. refer page 36/37 for additional technical information. All dimensions in mm. Subject to change without prior notice.

<sup>1)</sup> 10-1000 Hz    <sup>2)</sup> 1-500 Hz    <sup>3)</sup> 1/2 sin 2 ms



## Features

- > Most economic Reed Switch for automated assembly
- > Assembly in PCB cutout reduces height above PCB by approx. 50%
- > Various sensitivity ranges and total lengths variants

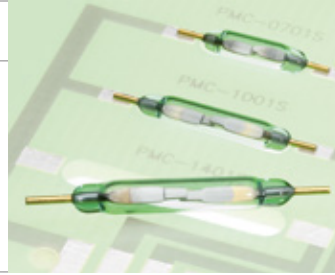

		PMC-0701S	PMC-1001S	PMC-1401S	PMC-1424S	PMC-1428S	PMC-2021S
Contact form		A	A	A	A	A	A
Contact rating max.	W / VA	10	10	10	10	10	50
Switching current max.	A	0.5	0.7	1	0.5	0.5	1.5
Switching voltage max.	VDC	150	180	200	200	100	200
	VAC	120	130	140	140	100	250
Pull in range available	AT	10-20	10-25	10-25	10-30	10-35	25-40
UL / CSA / RoHS		• / • / •	• / • / •	• / • / •	• / • / •	• / • / •	• / • / •

PMC-0701S

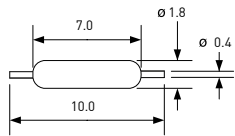

PMC-1001S

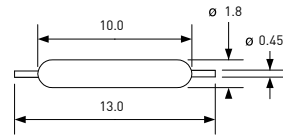

PMC-1401S  
PMC-1424S  
PMC-1428S

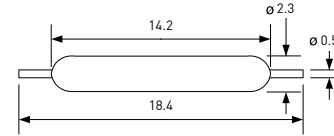

PMC-2021S

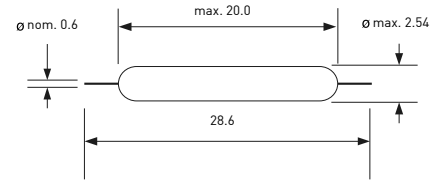

## PCB cutout

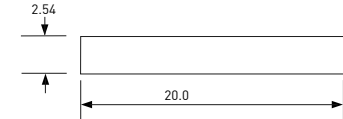
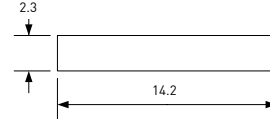
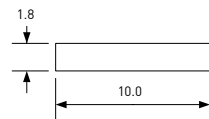
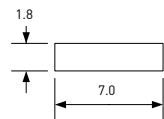

## Recommended pad size

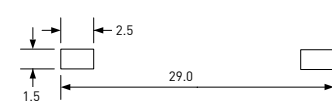
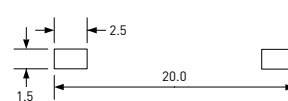
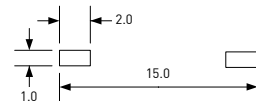
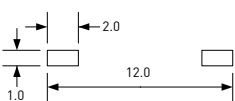

AT ranges and characteristics stated for unmodified Reed Switches.  
Pls. refer page 36/37 for additional technical information. All dimensions in mm. Subject to change without prior notice.



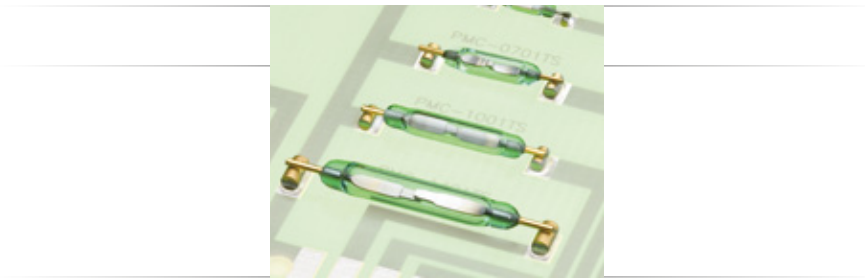

## Features

- > Attractively priced alternative to molded Reed Switches
- > No PCB redesign required since direct substitute for molded competitors types
- > Various sensitivity ranges available

		HSR-0025TSM	PMC-0701TS	PMC-1001T/TS	PMC-1401T/TS	PMC-1424T/TS	PMC-1428T/TS	PMC-2021T
Contact form		A	A	A	A	A	A	A
Contact rating max.	W / VA	0.25	10	10	10	10	10	50
Switching current max.	A	0.01	0.5	0.7	1	0.5	0.5	1.5
Switching voltage max.	VDC	30	150	180	200	200	100	200
	VAC	20	120	130	140	140	100	250
Pull in range available	AT	2-15	10-20	10-25	10-25	10-30	10-35	25-40
UL / CSA / RoHS		--/--/•	•/•/•	•/•/•	•/•/•	•/•/•	•/•/•	•/•/•

### HSR-0025TSM

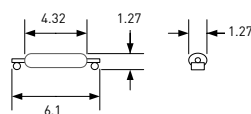

Recommended pad size

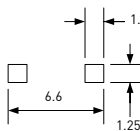

### PMC-0701TS

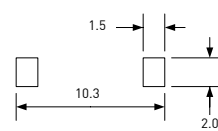
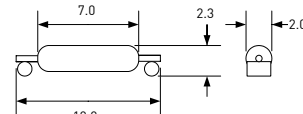

### PMC-1001TS

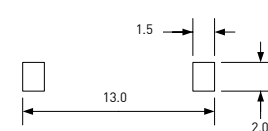
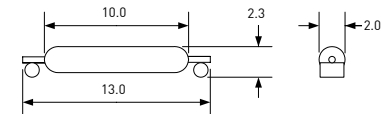

### PMC-1001T

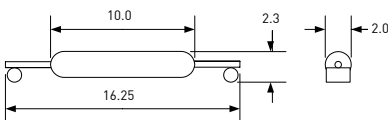

Recommended pad size

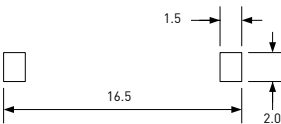

### PMC-1401TS PMC-1424TS PMC-1428TS

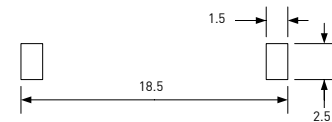
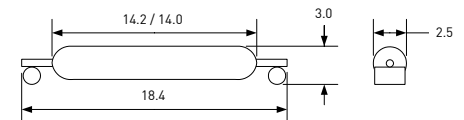

### PMC-1401T PMC-1424T PMC-1428T

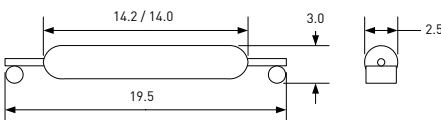

Recommended pad size



### PMC-2021T

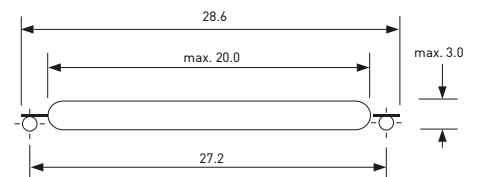

AT ranges and characteristics stated for unmodified Reed Switches.  
Pls. refer page 36/37 for additional technical information. All dimensions in mm. Subject to change without prior notice.

# Z-Series



Distribución de componentes eléctricos y electrónicos

Tel.: (+34) 902 450 160

Fax: (+34) 902 433 088

[ermec@ermec.com](mailto:ermec@ermec.com)

[www.ermec.com](http://www.ermec.com)

## Features

- › Designed to lay in PCB cut out
- › Smallest height over PCB with only 0.45 mm for PMC-0701Z
- › Improved mechanical protection for glass body

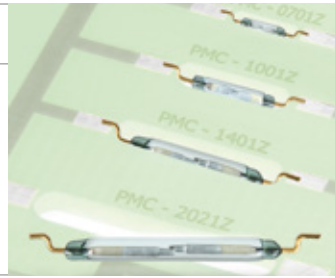

		PMC-0701Z	PMC-1001Z	PMC-1401Z	PMC-2021Z
Contact form		A	A	A	A
Contact rating max.	W / VA	10	10	10	50
Switching current max.	A	0.5	0.7	1	1.5
Switching voltage max.	VDC	150	180	200	200
	VAC	120	130	140	250
Pull in range available	AT	10-20	10-25	10-25	25-40
UL / CSA / RoHS		-- / -- / •	-- / -- / •	-- / -- / •	-- / -- / •

PMC-0701Z

PMC-1001Z

PMC-1401Z

PMC-2021Z

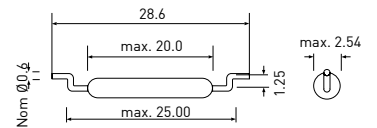
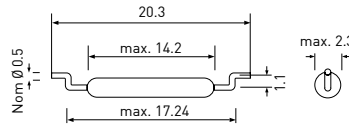
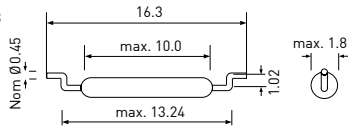
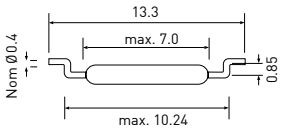

## PCB cutout

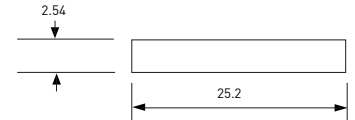
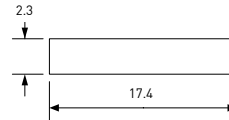
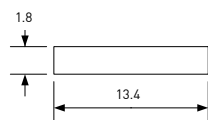
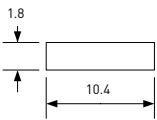

## Recommended pad size

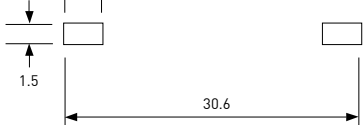
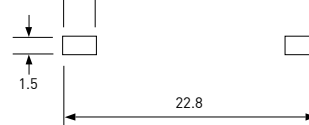
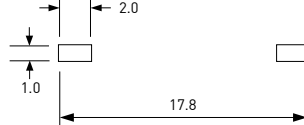
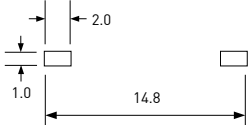

AT ranges and characteristics stated for unmodified Reed Switches.  
Pls. refer page 36/37 for additional technical information. All dimensions in mm. Subject to change without prior notice.

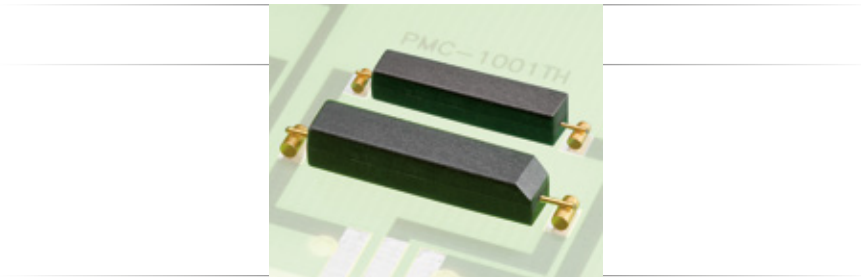

## Features

- › Replaces various molded competitors types, thus no PCB redesign required
- › Latching and Form B (normally closed) types available
- › Various sensitivity ranges available

		PMC-0508TH	PMC-0701TH	PMC-1001TH PMC-1001THL	Normally closed PMC-1001THY	Latching PMC-1424THX
Contact form		A	A	A	B	E
Contact rating max.	W/VA	5	10	10	10	5
Switching current max.	A	0.25	0.5	0.7	0.7	0.5
Switching voltage max.	VDC	175	150	180	180	140
	VAC	140	120	130	130	100
Pull in range available	AT	5-15	10-20	10-25	consult factory	consult factory
UL / CSA / RoHS		--/--/•	•/•/•	•/•/•	•/•/•	•/•/•

PMC-0508TH

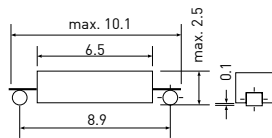

PMC-0701TH

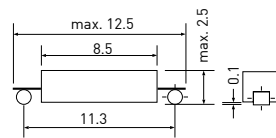

PMC-1001TH

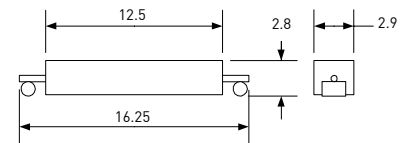

### Recommended pad size

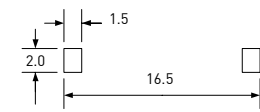
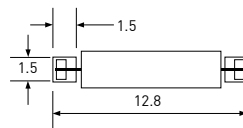
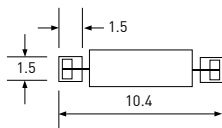

PMC-1001THL

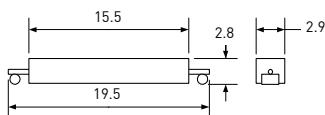

PMC-1001THY

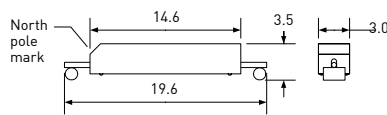

PMC-1424THX

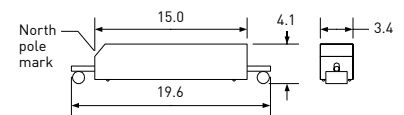

### Recommended pad size

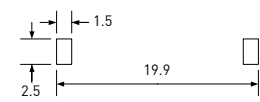
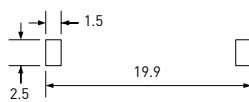
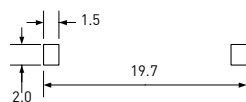

AT ranges and characteristics stated for unmodified Reed Switches.  
Pls. refer page 36/37 for additional technical information. All dimensions in mm. Subject to change without prior notice.

## Features

- > Ultra miniature size
- > Hi-Rel versions available
- > Various sensitivity ranges available

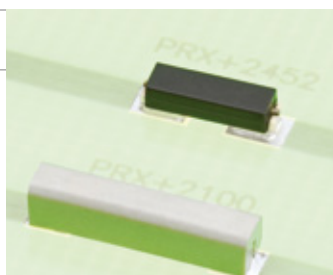

		PRX+2463	PRX+2131
Contact form		A	A
Contact rating max.	W / VA	0.25	1
Switching current max.	A	0.01	0.05
Switching voltage max.	VDC	30	30
	VAC	20	30
Pull in range available	AT	5-15	5-20
UL / CSA / RoHS		--/--/•	--/--/•

PRX+2463

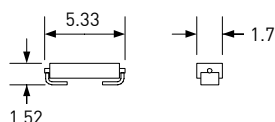

PRX+2131

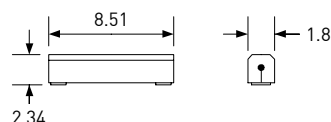

Recommended pad size

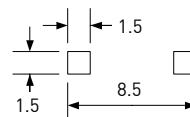
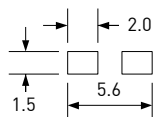

ERMEC, S.L. BARCELONA  
 C/ Francesc Teixidó, 22  
 08918 Badalona  
 (España)

Tel.: (+34) 902 450 160  
 Fax: (+34) 902 433 088  
[info@ermec.com](mailto:info@ermec.com)  
[www.ermec.com](http://www.ermec.com)

ERMEC, S.L. MADRID  
 c/Mejorada, 17,1ªPl. Of.D4  
 28850 Torrejón de Ardoz  
 (España)

PORTUGAL  
[portugal@ermec.com](mailto:portugal@ermec.com)  
 BILBAO  
[bilbao@ermec.com](mailto:bilbao@ermec.com)

# Reed Sensor Basics



## How does a Reed Sensor work?

A Reed Sensor incorporates a Reed Switch inside a metal or plastic housing for better mechanical protection and easier mounting.

Actuation principles for Reed Switches also apply to Reed Sensors.

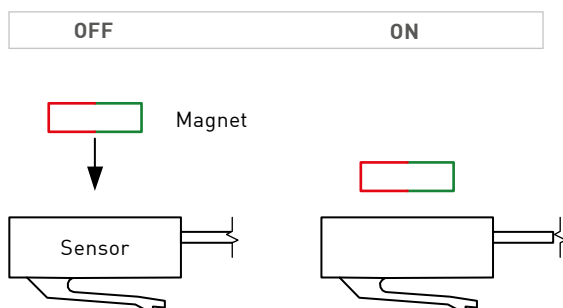

## Benefits

- > Mechanically protected
- > Wide range of housing types available
- > No power supply required
- > Not ESD sensitive
- > Non-touch actuation permits smooth surfaces and modern design
- > Various sensitivity ranges available

We supply Reed Sensors to any requirement: for snap-fit or screw mounting, with special cable and connector etc.

## Applications





		MS-328-3 MS-332-3	MS-328-4	MS-328-5 MS-332-5	MS-328-6 MS-332-6	MS-328-7 MS-332-7
Contact form		A	C	A	A	B
Contact rating max.	W / VA	10	5	10	50	5
Switching current max.	A	1	0.25	0.3	1.5	0.25
Switching voltage max.	VDC	200	175	200	200	175
	VAC	140	120	260	250	120
Pull in range available	AT	10-25	15-30	15-30	25-40	15-30
Operating Temperature	°C	-20 to +85	-20 to +85	-20 to +85	-20 to +85	-20 to +85
UL / CSA / RoHS		•/•/•	•/•/•	•/•/•	•/•/•	•/•/•

	MS-328	MS-332
Housing material	PA66-GF	ABS
Cable type	AWG 20	AWG 24
	[MS-328-4: AWG 22]	

Matching actuators on page 32/33.

## Standard types

Cable exit: right

### MS-328

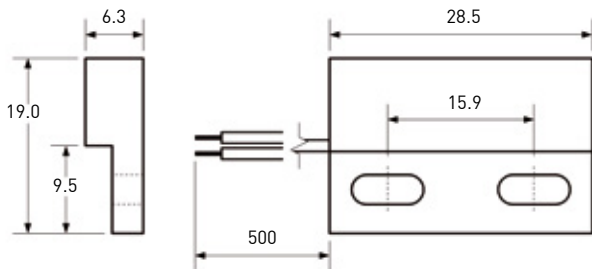

### MS-332

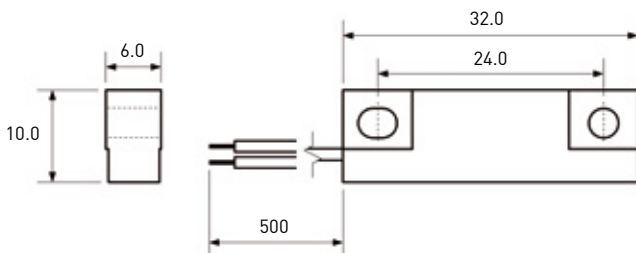

### MS-332R

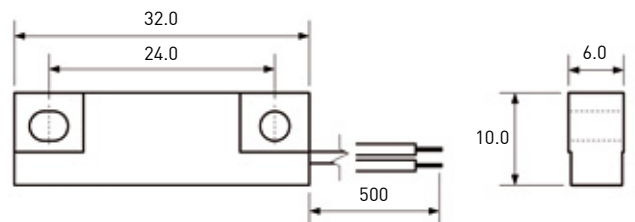

AT ranges and characteristics stated for unmodified Reed Switches.  
Pls. refer page 36/37 for additional technical information. All dimensions in mm. Subject to change without prior notice.



## Features

- > Pitch ranging from 2.54 to 20.32 mm
- > Mechanically protected
- > Replaces various competitors types
- > MK sensor with integrated resistor
- > Mains voltage variants available
- > Customized types available

		MS-104 MS-105	MS-106	MS-107	MS-108-3	MS-108-4	MS-108-5	MK
Contact form		A	A	A	A	C	A	A
Contact rating max.	W/VA	10	10	10	10	5	10	10
Switching current max.	A	0.5	0.7	0.7	1	0.25	0.3	0.5
Switching voltage max.	VDC	150	180	180	2w00	175	200	150
	VAC	120	130	130	140	120	260	120
Pull in range available	AT	10-20	10-25	10-25	10-25	15-30	15-30	10-15
Operating Temperature	°C	-20 to +85	-20 to +85	-20 to +85	-20 to +85	-20 to +85	-20 to +85	-40 to +125
UL / CSA / RoHS		•/•/•	•/•/•	--/--/•	•/•/•	•/•/•	•/•/•	--/--/•

MS-104

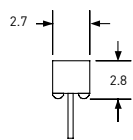
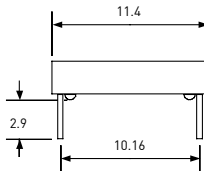

MS-105

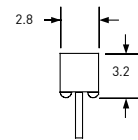
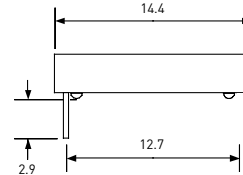

MS-106

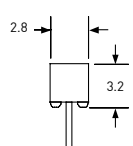
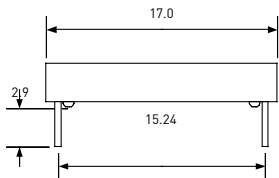

MS-107

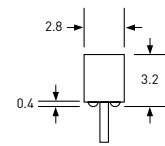
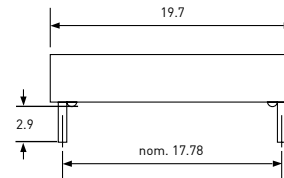

MS-108

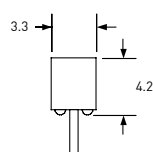
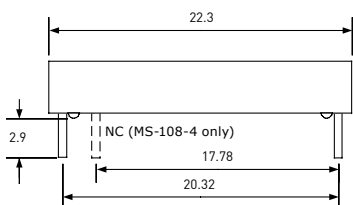

MK with integrated resistor

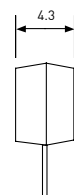
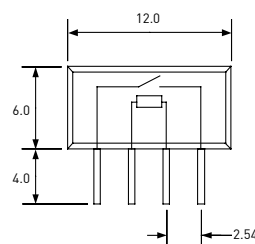

AT ranges and characteristics stated for unmodified Reed Switches.  
Pls. refer page 36/37 for additional technical information. All dimensions in mm. Subject to change without prior notice.

## Features

- > Replaces various competitors types
- > Mains voltage variants available
- > Various sensitivity ranges available
- > Customized types available



		PRX+1500	MS-209	MS-210	MS-211	MS-213	MS-214
Contact form		A	A	A	A	A	A
Contact rating max.	W / VA	1	10	10	10	10	10
Switching current max.	A	0.05	0.5	0.5	0.5	0.7	0.7
Switching voltage max.	VDC	30	150	150	150	180	180
	VAC	30	120	120	120	130	130
Pull in range available	AT	10-25	10-20	10-20	10-20	10-25	10-25
Operating Temperature	°C	-40 to +125	-20 to +85	-20 to +85	-20 to +85	-20 to +85	-20 to +85
UL / CSA / RoHS		--/--/•	--/--/•	--/--/•	--/--/•	•/--/•	•/--/•
Housing material		HTM	ABS	ABS	ABS	ABS	ABS
Cable type		AWG 28	AWG 30	AWG 26	AWG 26	AWG 26	AWG 26

### PRX+1500

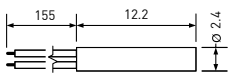

### MS-209

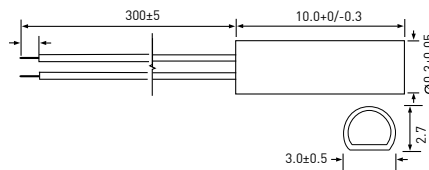

### MS-210

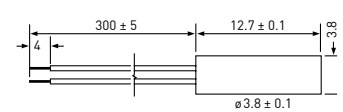

### MS-211

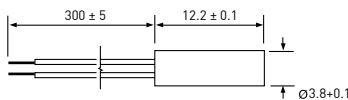

### MS-213

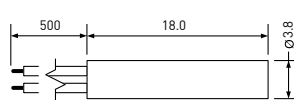

### MS-214

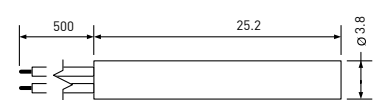

		MS-215-3 MS-216-3 MS-217-3	MS-215-4 MS-216-4 MS-217-4	MS-215-5 MS-216-5 MS-217-5	MS-217-6	MS-215-7 MS-216-7 MS-217-7
Contact form		A	C	A	A	B
Contact rating max.	W / VA	10	5	10	50	5
Switching current max.	A	1	0.25	0.3	1.5	0.25
Switching voltage max.	VDC	200	175	200	200	175
	VAC	140	120	260	250	120
Pull in range available	AT	10-25	15-30	15-30	25-40	15-30
Operating Temperature	°C	-20 to +85	-20 to +85	-20 to +85	-20 to +85	-20 to +85
UL / CSA / RoHS		•/•/•	•/•/•	•/•/•	•/•/•	•/•/•
Housing material		ABS	ABS	ABS	ABS	ABS
Cable type		AWG 24	AWG 24	AWG 24	AWG 24	AWG 24

### MS-215

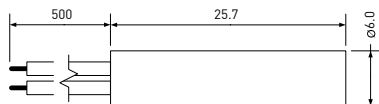

### MS-217

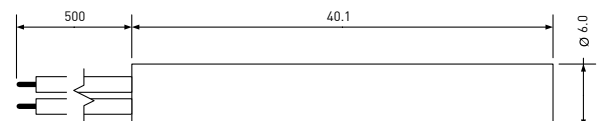

### MS-216

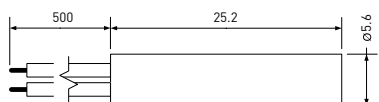

AT ranges and characteristics stated for unmodified Reed Switches.  
Pls. refer page 36/37 for additional technical information. All dimensions in mm.  
Subject to change without prior notice.



# Tubular Threaded



## Features

- > Adjustable switching point
- > Replaces various competitors types
- > Mains voltage variants available
- > Various sensitivity ranges available
- > Customized types available

		MS-225
Contact form		A
Contact rating max.	W / VA	10
Switching current max.	A	0.7
Switching voltage max.	VDC	180
	VAC	130
Pull in range available	AT	10-25
Operating Temperature	°C	-20 to +85
UL / CSA / RoHS		• / - / •
<b>Housing material</b>		
		Nickel plated brass
<b>Cable type</b>		
		AWG 28

MS-225

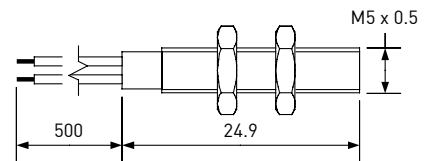

		MS-228-3	MS-228-4	MS-228-5	MS-228-6	MS-228-7
Contact form		A	C	A	A	B
Contact rating max.	W / VA	10	5	10	50	5
Switching current max.	A	1	0.25	0.3	1.5	0.25
Switching voltage max.	VDC	200	175	200	200	175
	VAC	140	120	260	250	120
Pull in range available	AT	10-25	15-30	15-30	25-40	15-30
Operating Temperature	°C	-20 to +85	-20 to +85	-20 to +85	-20 to +85	-20 to +85
UL / CSA / RoHS		• / • / •	• / • / •	• / • / •	• / • / •	• / • / •
<b>Housing material</b>						
		PA6-GF	PA6-GF	PA6-GF	PA6-GF	PA6-GF
<b>Cable type</b>						
		AWG 24	AWG 24	AWG 24	AWG 24	AWG 24

Matching actuators on page 32/33.

MS-228

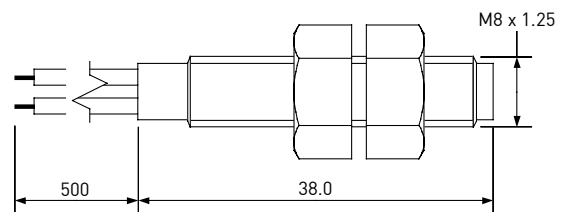

AT ranges and characteristics stated for unmodified Reed Switches.  
Pls. refer page 36/37 for additional technical information. All dimensions in mm. Subject to change without prior notice.

# Tubular Threaded

## Features

- > Adjustable switching point
- > Rugged design
- > Various sensitivity ranges available
- > Customized types available

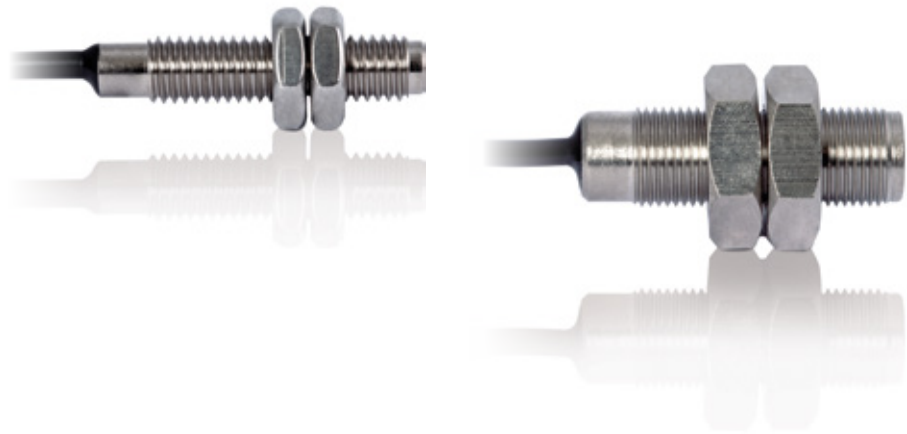

		Power Switch	
		MS-226M-3 MS-228M-3 MS-2210M-3 MS-2212M-3	MS-228M-6 MS-2210M-6 MS-2212M-6
Contact form		A	A
Contact rating max.	W / VA	10	50
Switching current max.	A	1	1.5
Switching voltage max.	VDC	200	200
	VAC	140	250
Pull in range available	AT	10-25	25-40
Operating Temperature	°C	-20 to +85	-20 to +85
UL / CSA / RoHS		--/--/•	--/--/•
Housing material		Nickel plated brass	Nickel plated brass
Cable type		UL 2464, AWG 24 (MS-226M-3: AWG 28)	UL 2464, AWG 24

Matching actuators on page 32/33.

MS-226M

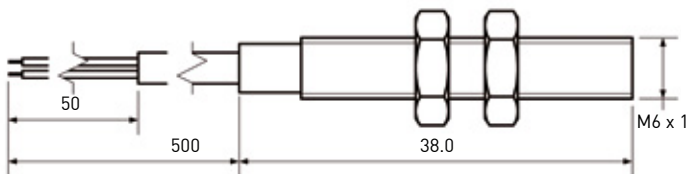

MS-228M

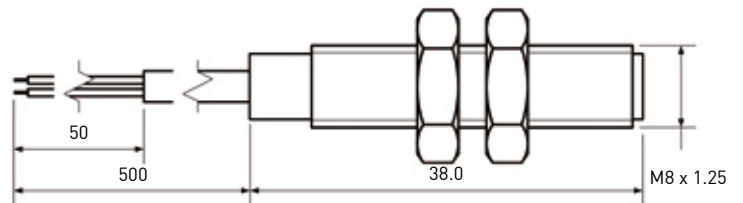

MS-2210M

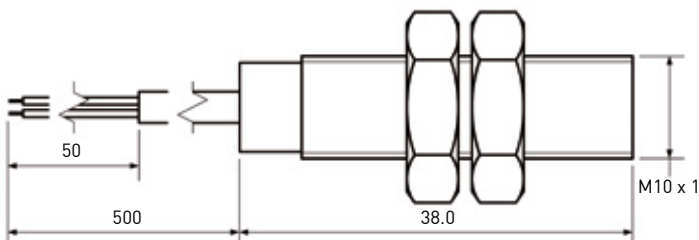

MS-2212M

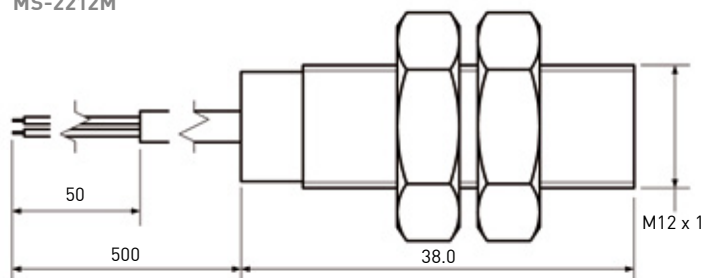

AT ranges and characteristics stated for unmodified Reed Switches.  
Pls. refer page 36/37 for additional technical information. All dimensions in mm. Subject to change without prior notice.



## Features

- > Easily mountable, no tools or screws required
- > Various sensitivity ranges available
- > Customized sizes and diameters available

		MS-2431-3	MS-2431-4	MS-2431-7
Contact form		A	C	B
Contact rating max.	W/VA	10	3	3
Switching current max.	A	1	0.2	0.2
Switching voltage max.	VDC	200	30	30
	VAC	140	30	30
Pull in range available	AT	10-25	10-30	10-30
Operating Temperature	°C	-20 to +85		
UL / CSA / RoHS		--/--/•		
Housing material		PA-GF		
Cable type		UL 1569, AWG 24		

### MS-2431

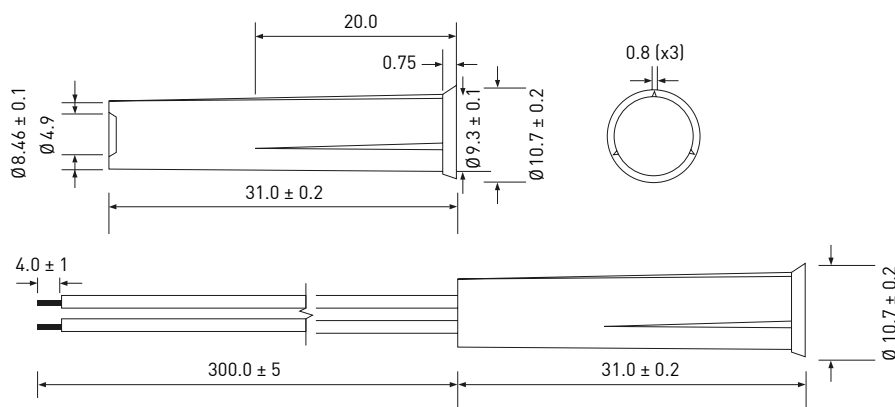

# Level Sensor Basics



## How does a Level Sensor work?

A Level Sensor incorporates a Reed Switch in a stem. An external float, with a magnet inside, passes and actuates the Reed Switch, depending on liquid level.

Actuation principles for Reed Switches also apply to Level Sensors.

## Benefits

- > No power supply required
- > Various housing materials available
- > Form A and Form B
- > Suitable for food contact
- > Customized types available

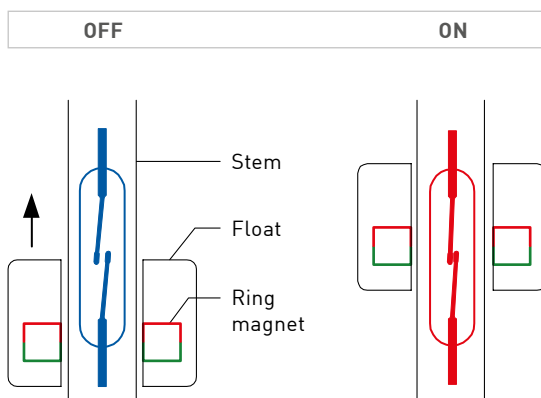

## Applications



# PLS-PP-Series

IP 67

## Features

- > Polypropylene housing
- > Form A and Form B
- > Suitable for food contact
- > Covers a wide range of applications
- > Customized types available

						Power Switch	
		PLS-020A-3PP	PLS-020B-3PP	PLS-031A-3PP	PLS-031B-3PP	PLS-031A-6PP	PLS-031B-6PP
		A	B	A	B	A	B
Contact form		A	B	A	B	A	B
Contact rating max.	W / VA	10		10		50	
Switching current max.	A	0.7		1		1.5	
Carry current max.	A	1		1.2		2	
Switching voltage max.	VDC	180		200		200	
	VAC	130		140		250	
Breakdown voltage min.	VDC	200		240		400	
Operating Temperature	°C	-20 to +80		-20 to +80		-20 to +80	
UL / CSA / RoHS		•/•/•		•/•/•		•/•/•	
Housing material		PP		PP		PP	
Cable type		AWG 24		AWG 24		AWG 22	

PLS-020 – world's smallest!

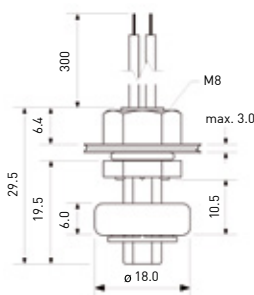

PLS-031 – Miniature

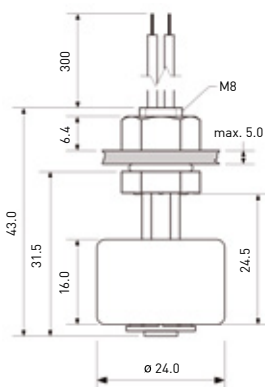

PLS-041 – Standard

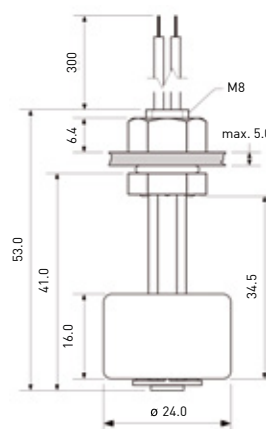

## Variants & mounting

### FORM A (Normally open)

### FORM B (Normally closed)

### Top mounting

### Bottom mounting

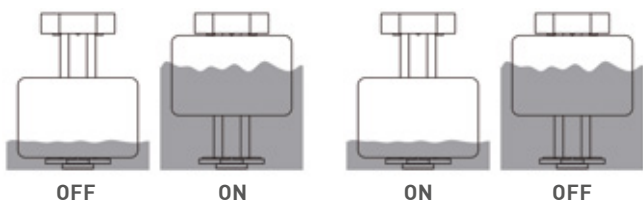

When mounted „stem up“, operating functions are reversed.

# PLS-PP-Series



Distribución de componentes eléctricos y electrónicos

Tel.: (+34) 902 450 160  
 Fax: (+34) 902 433 088  
[ermec@ermec.com](mailto:ermec@ermec.com)  
[www.ermec.com](http://www.ermec.com)



## Features

- > Screw mounting from outside
- > PP float material
- > POM housing material
- > Covers a wide range of applications

		PLS-051A-3PPI
Contact form		A
Contact rating max.	W / VA	10
Switching current max.	A	0,5
Carry current max.	A	1
Switching voltage max.	VDC	200
	VAC	140
Breakdown voltage min.	VDC	250
<b>Operating Temperature</b>		
Operating Temperature	°C	-20 to +80
UL / CSA / RoHS		
--/--/•		
<b>Housing material</b>		
Housing material		PP, POM
<b>Cable type</b>		
Cable type		UL 1007, AWG 24

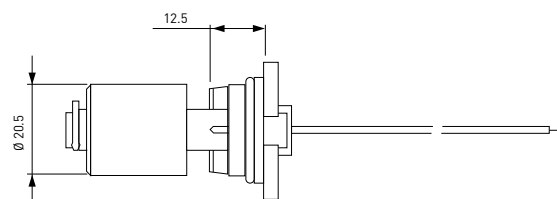
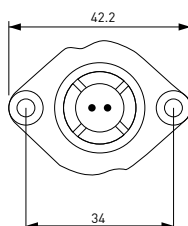
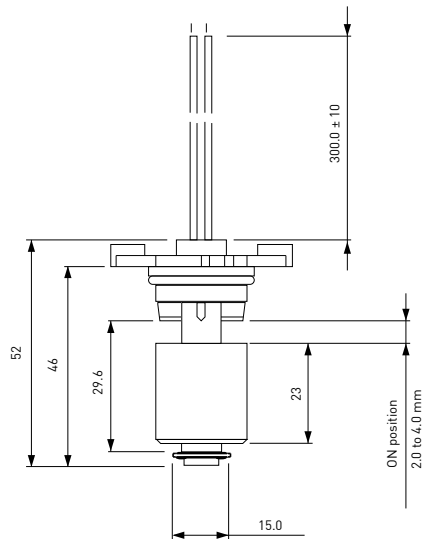

## PLS-PA-Series



IP 67

### Features

- > Polyamide housing
- > Form A and Form B
- > Extended temperature range
- > Customized types available

		PLS-031A-3PA		PLS-031B-3PA		Power Switch	
		PLS-041A-3PA		PLS-041B-3PA		PLS-031A-6PA	
		PLS-041A-6PA		PLS-041B-6PA		PLS-031B-6PA	
		A		B		A	
				B			
Contact rating max.	W / VA	10		50			
Switching current max.	A	1		1.5			
Carry current max.	A	1.2		2			
Switching voltage max.	VDC	200		200			
	VAC	140		250			
Breakdown voltage min.	VDC	240		400			
Operating Temperature	°C	-20 to +80		-20 to +80			
UL / CSA / RoHS		• / • / •		• / • / •			
Housing material		PA		PA			
Cable type		AWG 24		AWG 22			

PLS-031 - Miniature

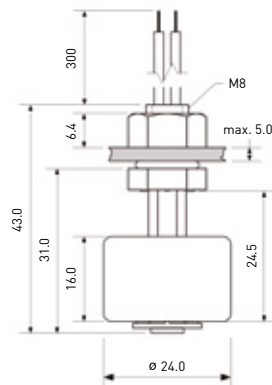

PLS-041 - Standard

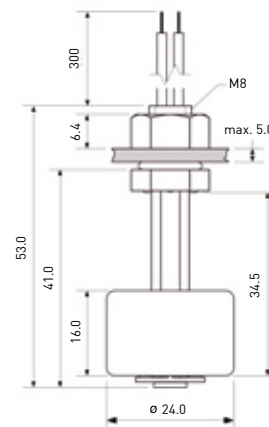

### Variants & mounting

#### FORM A (Normally open)

#### FORM B (Normally closed)

#### Top mounting

#### Bottom mounting

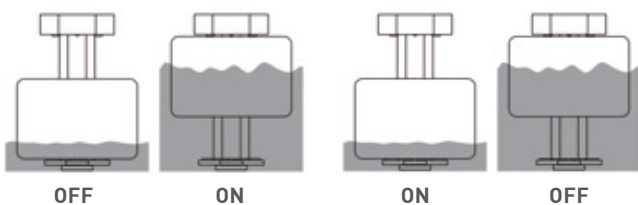

When mounted „stem up“, operating functions are reversed.

# PLS-VA-Series

**IP 67**



## Features

- > Stainless Steel housing
- > Rugged & durable
- > Form A and Form B
- > Suitable for food contact
- > Extended temperature range
- > Customized types available

		PLS-045A-3VAI		PLS-045B-3VAI		Power Switch			
		PLS-080A-3VAL		PLS-080B-3VAL		PLS-045A-6VAI		PLS-045B-6VAI	
		A		B		A		B	
Contact rating max.	W / VA	10				50			
Switching current max.	A	1				1.5			
Carry current max.	A	1.2				2			
Switching voltage max.	VDC	200				200			
	VAC	140				250			
Breakdown voltage min.	VDC	240				400			
Operating Temperature	°C	-40 to +125				-40 to +125			
UL / CSA / RoHS		•/•/•				•/•/•			
Housing material		Stainless Steel 304				Stainless Steel 304			
Cable type		AWG 24				AWG 22			

PLS-045

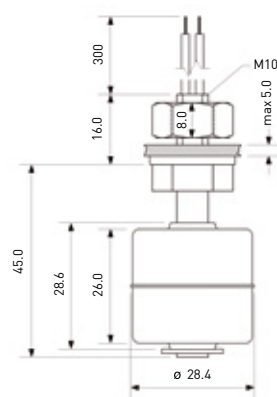

PLS-080

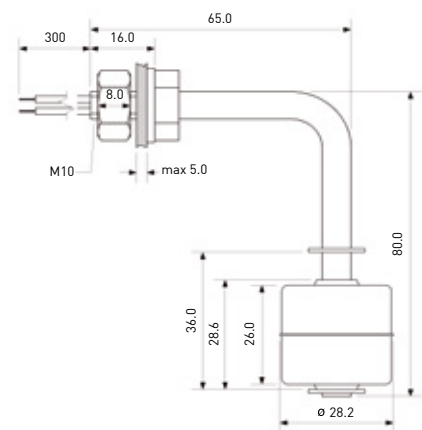

## Variants & mounting

**FORM A (Normally open)**

**FORM B (Normally closed)**

**Top mounting**

**Bottom mounting**

**Side mounting**

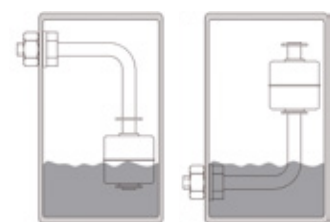
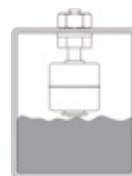
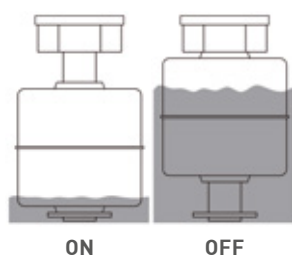
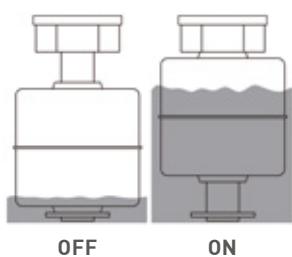

When mounted „stem up“, operating functions are reversed.





**Features**

- > Assembly from outside
- > Level Sensors for horizontal mounting
- > Polypropylene housing
- > Covers a wide range of applications

		PLS-092A-3PPH
Contact form		A
Contact rating max.	W/VA	10
Switching current max.	A	1
Carry current max.	A	1.2
Switching voltage max.	VDC	200
	VAC	140
Breakdown voltage min.	VDC	240
<b>Operating Temperature</b>		
Operating Temperature	°C	-20 to +65
<b>UL / CSA / RoHS</b>		
UL / CSA / RoHS --/--/•		
<b>Housing material</b>		
Housing material		PP
<b>Cable type</b>		
Cable type		UL 2464, AWG 22

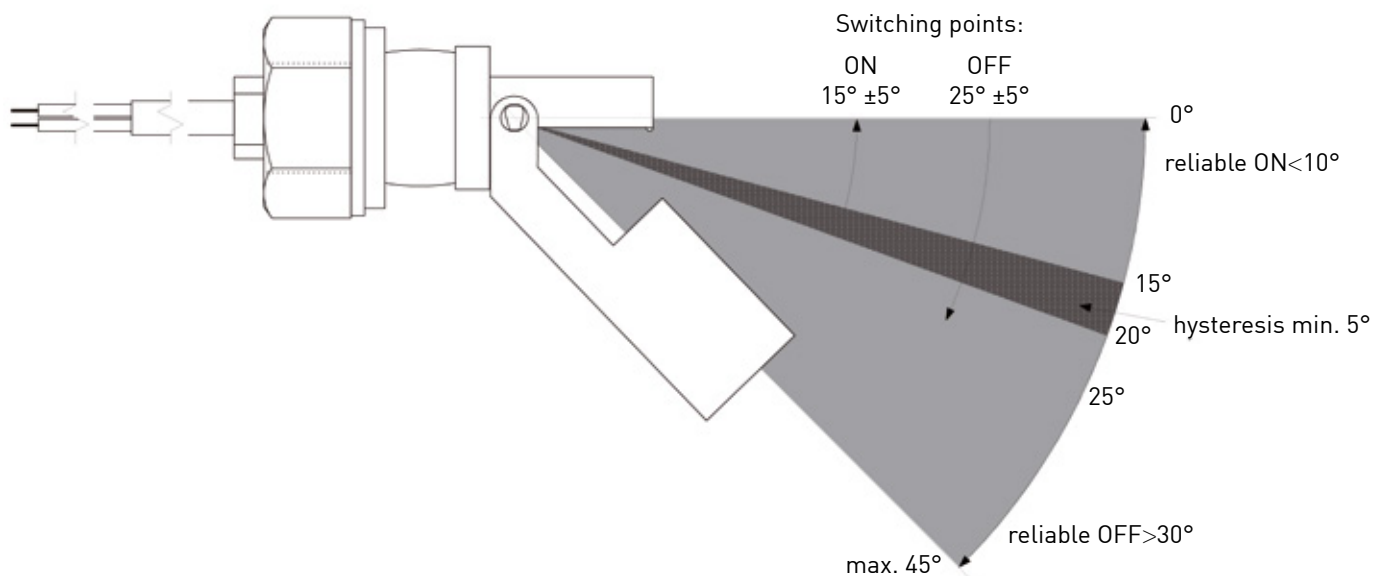
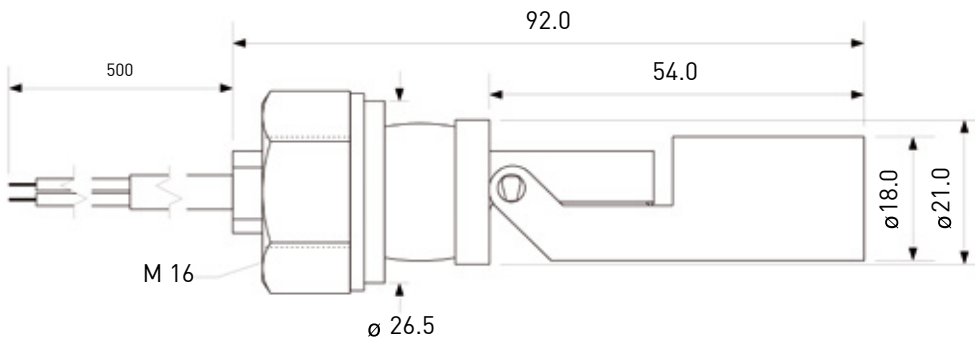

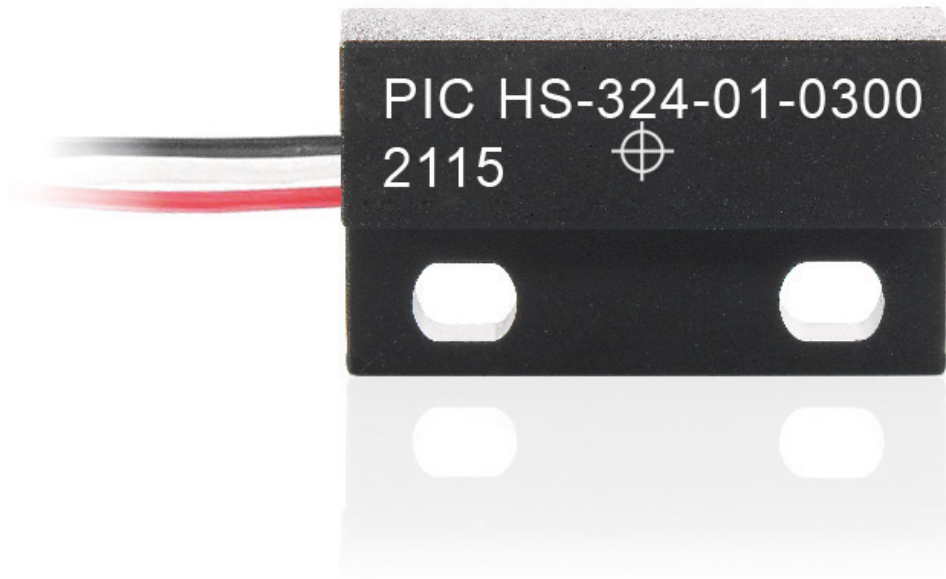

## How does a Hall Sensor work?

A Hall Sensors contains an IC which reacts to a magnetic field by changing its output status. This change can be interpreted as ON/OFF signal by a logic.

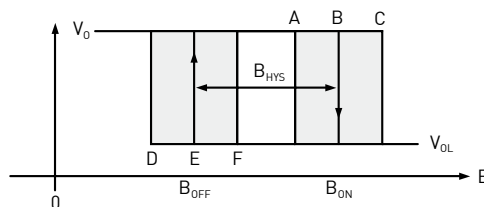
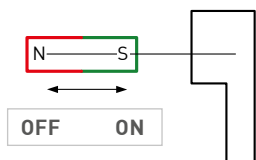

## Benefits

- > No mechanical movement, basically no wear
- > Higher "switching frequency" compared to Reed Sensors
- > Mechanically protected
- > Easy assembly

## Applications



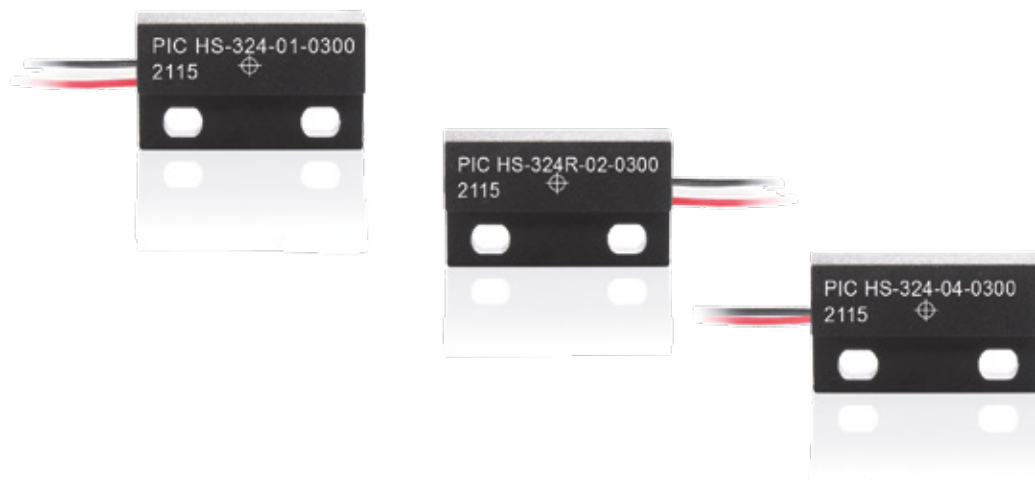

### Features

- > Compact housing
- > Ideal sensing point marked
- > Various chip positions inside the housing possible

		HS-324-01 HS-324R-01	HS-324-02 HS-324R-02	HS-324-03 HS-324R-03	HS-324-04 HS-324R-04	HS-324-05 HS-324R-05
Type		Bipolar	Latching	Unipolar	Latching	Unipolar
Wires		3 wire	3 wire	3 wire	2 wire	2 wire
$B_{on}/B_{off}$	<i>mT</i>	0.5 / -0.5	2.5 / -2.5	5.5 / 3.5	12.0 / -12.0	6.0 / 4.0
Supply current $I_s$ max	<i>mA</i>	2.4	2.4	2.4	5	2
Supply voltage min	<i>V</i>	2.7	2.7	2.7	3.0	3.0
Operating temperature	<i>°C</i>	-20 to +85				
Housing Material		ABS				
Cable type		UL1007, AWG 24				

#### HS-324

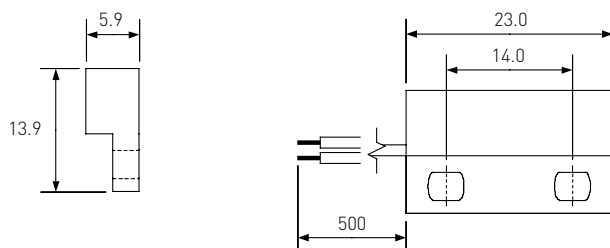

#### HS-324R

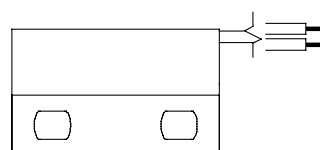

## Features

- › Adjustable switching point
- › Rugged design
- › Ideal sensing point on front side

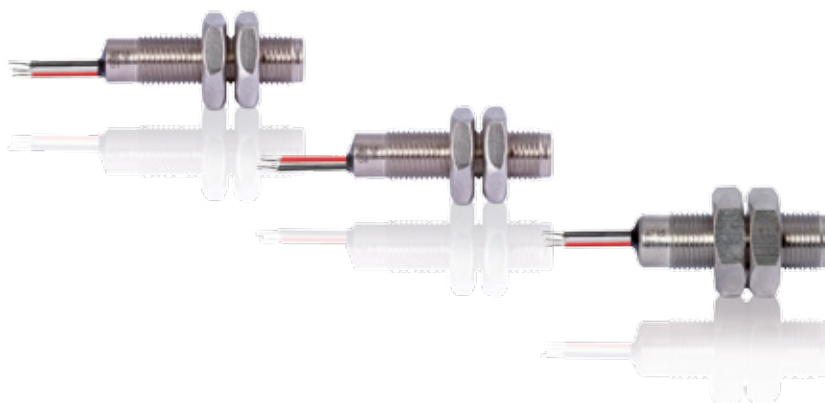

		HS-2210M-01 HS-2212M-01	HS-2210M-02 HS-2212M-02	HS-2210M-03 HS-2212M-03	HS-2210M-04 HS-2212M-04	HS-2210M-05 HS-2212M-05
Type		Bipolar	Latching	Unipolar	Latching	Unipolar
Wires		3 wire	3 wire	3 wire	2 wire	2 wire
$B_{on}/B_{off}$	mT	0.5 / -0.5	2.5 / -2.5	5.5 / 3.5	12.0 / -12.0	6.0 / 4.0
Supply current $I_s$ max	mA	2.4	2.4	2.4	5	2
Supply voltage min	V	2.7	2.7	2.7	3.0	3.0
Operating temperature	°C	-20 to +85				
Housing Material		Nickel plated brass				
Cable type		UL1007, AWG 24				

HS-2210M

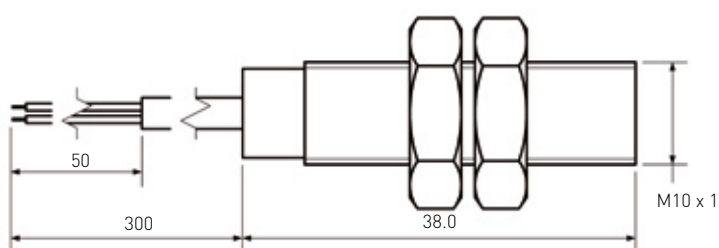

HS-2212M

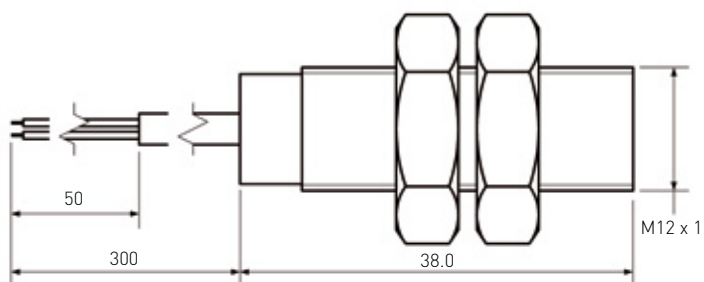

# Flange Mount

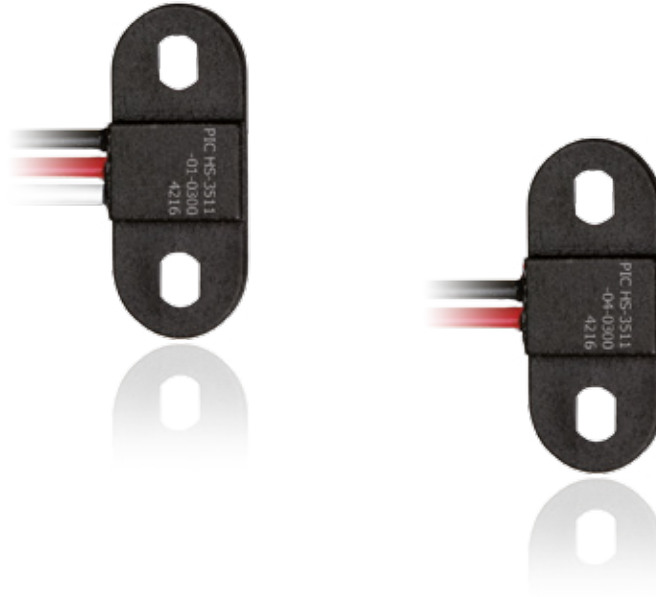

## Features

- > Ultra compact housing
- > Various sensitivities
- > Customized types available

		HS-3511-01	HS-3511-02	HS-3511-03	HS-3511-04	HS-3511-05
Type		Bipolar	Latching	Unipolar	Latching	Unipolar
Wires		3 wire	3 wire	3 wire	2 wire	2 wire
$B_{on} / B_{off}$	<i>mT</i>	0.5 / -0.5	2.5 / -2.5	5.5 / 3.5	12.0 / -12.0	6.0 / 4.0
Supply current $I_s$ max	<i>mA</i>	2.4	2.4	2.4	5	2
Supply voltage min	<i>V</i>	2.7	2.7	2.7	3.0	3.0
Operating temperature		-20 to +85				
Housing Material		PA6				
Cable type		UL1569, AWG 24				

HS-3511  
3-wire

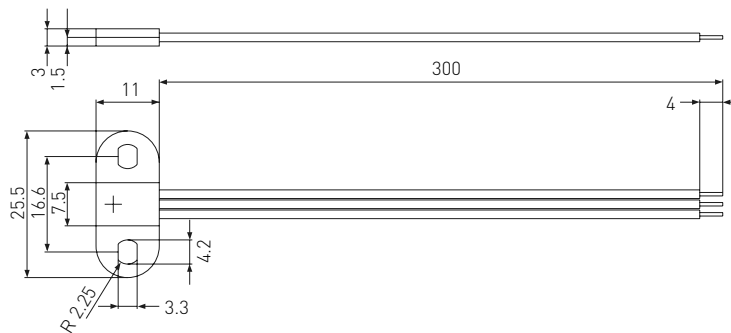

HS-3511  
2-wire

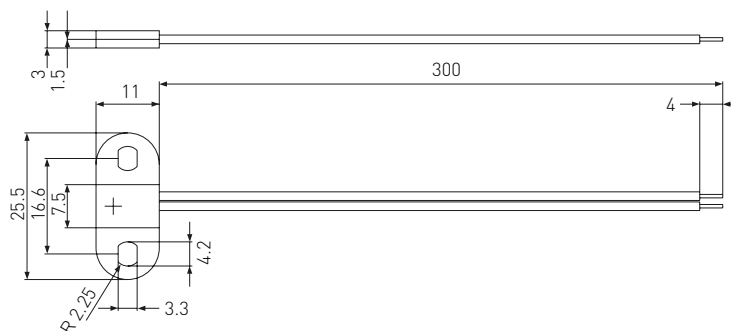

### Features

- > Easily mountable
- > Matches chosen Sensor
- > Mechanically protected
- > Customized types available



		MSM-225	MSM-226M	MSM-228	MSM-228M	MSM-2212M	MSM-2212M
Remanence Br	mT	1105	1105	1190	1190	1105	1105
Coercivity HcB	kA/m	836	836	828	828	836	836
Coercivity HcJ	kA/m	1274	1274	1274	1274	1274	1274
Energy Product (BH) max.	kJ/m <sup>3</sup>	235	235	275	235	235	235
Magnetic moment M	x10 <sup>-5</sup> Vs cm	1.21	14.6	1.5	25.5	43.6	43.6
Operating Temperature max.	°C	85	85	85	85	85	85
UL / CSA / RoHS		--/--/•	--/--/•	--/--/•	--/--/•	--/--/•	--/--/•
Housing material		Nickel plated brass	Nickel plated brass	PA6-GF	Nickel plated brass	Nickel plated brass	Nickel plated brass

MSM-225

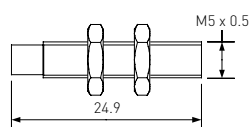

MSM-226M

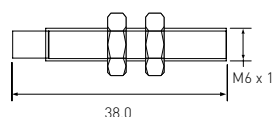

MSM-228

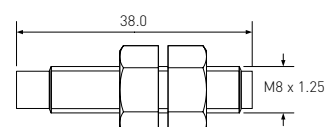

MSM-228M

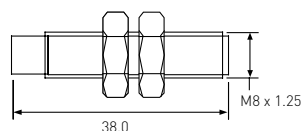

MSM-2210M

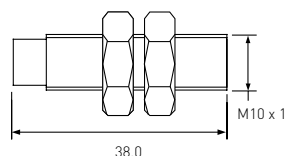

MSM-2212M

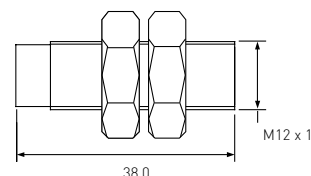



		MSM-2431	MSM-313	MSM-320	MSM-324	MSM-328	MSM-332
Remanence Br	mT	1190	1395	1190	1105	1105	1105
Coercivity HcB	kA/m	870	955	-	836	836	836
Coercivity HcJ	kA/m	1350	1353	1512	1274	1274	1274
Energy Product (BH) max.	$\text{kJ/m}^3$	275	378	275	235	235	235
Magnetic moment M	$\times 10^{-5} \text{Vs cm}$	10.0	0.3	2.4	3.42	3.42	4.1
Operating Temperature max.	°C	85	85	85	85	85	85
UL / CSA / RoHS		--/--/•	--/--/•	--/--/•	--/--/•	--/--/•	--/--/•
Housing material		PA-GF	ABS	PA66-GF	ABS	PA66-GF	ABS

MSM-2431

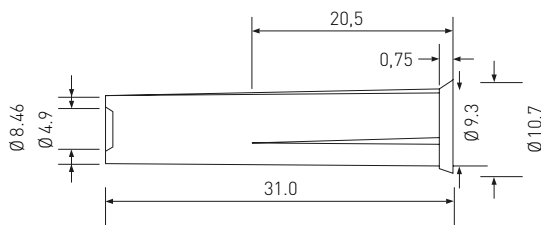

MSM-313

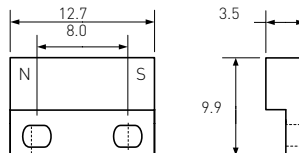

MSM-320

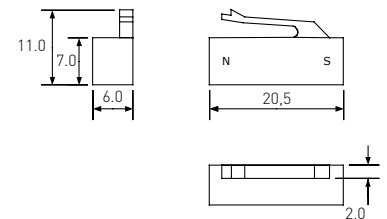

MSM-324

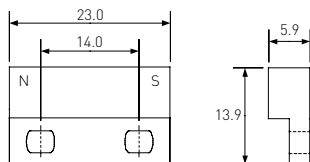

MSM-328

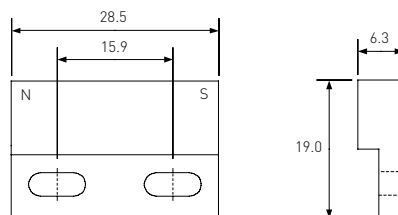

MSM-332

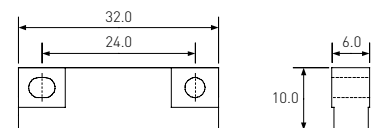

Check table below for most convenient magnet material

Selection Guide	LOW					HIGH
Costs	Ferrite	AlNiCo	NdFeB	SmCo		
Energy Product	Ferrite	AlNiCo	SmCo	NdFeB		
Operating Temperature	NdFeB	Ferrite	SmCo	AlNiCo		
Corrosion Resistance	NdFeB	SmCo	AlNiCo	Ferrite		
Resistance to Demagnetization	AlNiCo	Ferrite	NdFeB	SmCo		
Mechanical Strength	Ferrite	SmCo	NdFeB	AlNiCo		
Temperature Coefficient	AlNiCo	SmCo	NdFeB	Ferrite		

## Maximum power, minimum space

In recent years, Neodymium-Iron-Boron magnets (NdFeB) have advanced from being exotic luxury items to affordable power magnets.



## The benefits in sensor applications

- > Increased switching distance
- > Miniature design possible
- > Resistance to demagnetization
- > Greater product design flexibility

Material Grades		Remanence Br	Coercivity		Energy Product (BH) max.	Operating Temperature max.
		mT	kA/m	kA/m	kJ/m <sup>3</sup>	°C
NdFeB	N30	1105	836	955	235	80
	N30H	1105	836	1274	235	120
	N30SH	1100	836	1512	239	150
	N33EH	1185	828	955	275	180
	N35	1185	828	955	275	80
	N35H	1190	828	1274	275	120
	N35SH	1190	828	1512	275	150
	N40SH	1260	844	1512	314	150
	N45	1350	840	955	354	80
	N48H	1395	955	1353	378	120
SmCo5	S20	875	617	1194	159	250
Sm2Co17	S24H	975	724	1433	183	300
	S28H	1065	724	1433	215	300
AlNiCo	A500	1281	50	52	40	500
Ferrite	Y10	215	143	203	8	250
	Y30BH	390	229	231	29	300
	Y35	410	183	167	31	300
Bonded Ferrite	FB1	240	171	225	11	80
Bonded NdFeB	BN8	575	378	1035	64	150



**Over 80% of our products are *special custom designs*.**

## Connectors and cable assemblies

- › Sensor solutions + wire harnesses: taylor made to your requirements including RAST-Assembly



## Special housings

- › Own molding facilities spell flexibility when it comes to special housings, snap-fit solutions and inserts.



## PCB-Assemblies

- › Where large quantities in particular are concerned, assembly costs can make or break a product. We will be happy to supply Reed Switches and other components as fully assembled PCBs including cable and connector at highly competitive prices.

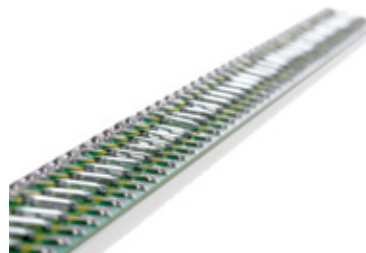

## Customized Level Sensors

- › We can do much more than what you see in this catalogue.



## Magnets

- › We design the matching actuator magnet for your application - bare or cased.



ERMEC, S.L. BARCELONA  
C/ Francesc Teixidó, 22  
08918 Badalona  
(España)

Tel.: (+34) 902 450 160  
Fax: (+34) 902 433 088  
[info@ermec.com](mailto:info@ermec.com)  
[www.ermec.com](http://www.ermec.com)

ERMEC, S.L. MADRID  
c/Mejorada, 17, 1ª Pla.Of.D4  
28850 Torrejón de Ardoz  
(España)

PORTUGAL  
[portugal@ermec.com](mailto:portugal@ermec.com)  
BILBAO  
[bilbao@ermec.com](mailto:bilbao@ermec.com)



# How to operate

In general **four** different magnet approaches are known when using permanent magnets

- 1 One magnet pole** faces Reed Switch providing **two** operations max. when moving on X-axis. Minimum movement of magnet over switch center provides smallest possible switching differential.

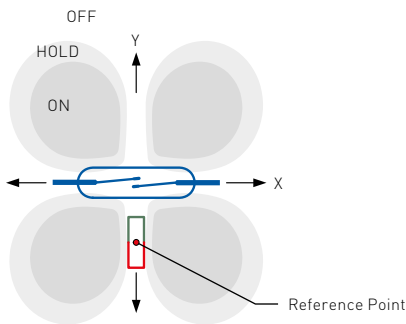

- 2 Magnet parallel to longitudinal axis of switch:** Approaching magnet **vertically** to switch on Y-axis provides **one** operation only. Driving magnet over full length of switch (X-axis) may result in up to three operations. Minimum movement of magnet over switch center provides smallest possible switching differential.

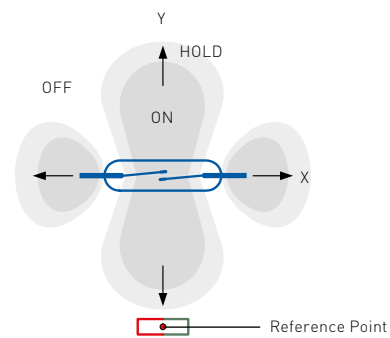

- 3 Switch operation by rotation** of magnet. This gives two operations per complete rotation.

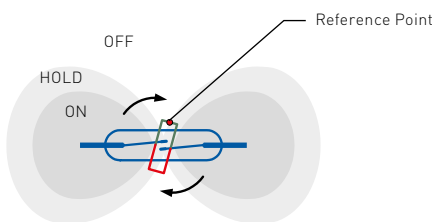

- 4 Operation of switch by shielding.** This method requires a permanently opposite location of magnet and switch. The switch is held closed continuously and will release only if magnet flux is removed by means of ferro-magnetic shield.

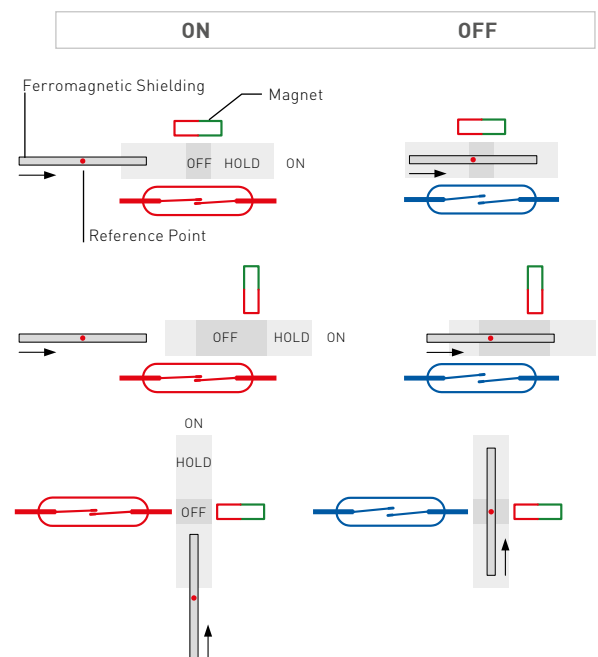

Check out our interactive Reed Switch here:  
[www.pic-gmbh.com/go](http://www.pic-gmbh.com/go)

## Shock Resistance

Generally Reed Switches provide high shock resistance up to 100 g. Still a drop on a hard surface can generate a shock of several 100 g, which can lead to de-adjustment of contacts. Switches having been dropped should be re-tested for sensitivity before usage!

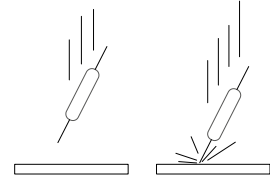

## Do's and Don'ts when cutting and bending Reed Switches

Incorrect bending or cutting of terminals may lead to cracks in the sealing area due to heavy mechanical stress. To avoid this problem the remaining part of terminal between glass body and point of bending resp. cutting, should be gripped tightly.

### Cutting

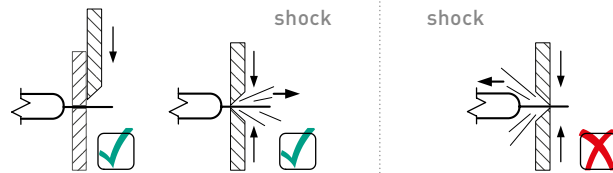

Forces directed away from Reed Switch

Forces directed toward Reed Switch!

### Bending

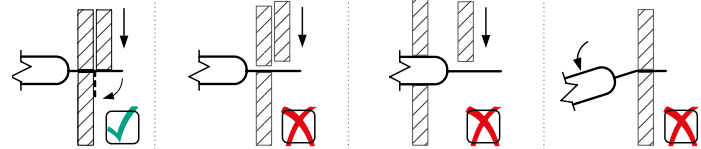

Terminal gripped tightly between glass body and point of bending

Terminal not gripped

Gripped on glass body

Terminal not gripped between glass body and point of bending

## Dimensioning of modified Reed Switches

We supply Reed Switches with terminals modified to nearly any requirement. Dimensioning should be made according to the examples below.

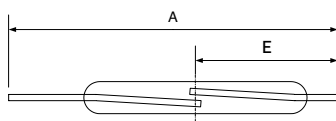

a) cut

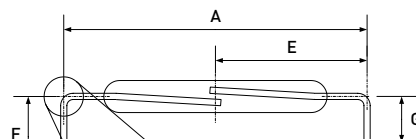

b) cut & bent

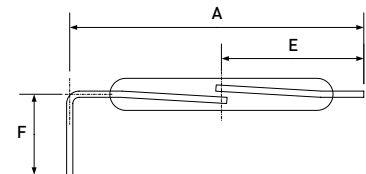

c) cut & bent

center wire

# Chemical resistance chart

+ = Excellent o = Limited - = Poor	Chemical resistance @20°C / @60°C				
	ABS	PA	PP	POM	Stainless Steel 304
Acetic Acid, dilute	- / -	- / -	+ / +	+ / o	+ / +
Acetone	- / -	+ / +	+ / o	+ / o	+ / +
Ammonium Hydroxide	o / -	+ / +	+ / +	+ / +	+ / +
Aniline	- / -	o / -	+ / +	- / -	+ / +
Beer, Wine, Whiskey	+ / +	+ / +	+ / +	+ / +	+ / +
Butanol	+ / o	+ / +	+ / +	+ / o	+ / +
Chloroform	- / -	- / -	- / -	- / -	+ / +
Citric Acid	+ / +	+ / +	+ / +	+ / -	o / o
Copper Sulphate	+ / +	- / -	+ / +	+ / +	o / o
Detergents	+ / o	+ / o	+ / +	+ / +	+ / +
Diesel fuel	+ / +	o / o	+ / o	+ / +	+ / +
Ethanol	+ / +	+ / +	+ / +	+ / +	+ / +
Ethylene Glycol	+ / +	+ / +	+ / +	+ / o	+ / +
Ferric Chloride	+ / +	- / -	+ / +	- / -	- / -
Formaldehyde (Formalin)	+ / +	o / o	+ / +	+ / +	+ / +
Formic Acid	+ / o	- / -	+ / +	- / -	+ / o
Fruit Juice	+ / +	+ / +	+ / +	+ / -	+ / +
Gasoline	- / -	- / -	- / -	+ / +	+ / +
Glycerol (Glycerin)	+ / +	+ / +	+ / +	+ / +	+ / +
Hydrochloric Acid	+ / -	- / -	+ / +	- / -	- / -
Hydrogen Peroxide, dilute	- / -	- / -	+ / +	o / -	+ / +
Lactic Acid	+ / +	o / -	+ / +	+ / -	+ / o
Methanol	- / -	o / -	+ / +	+ / +	+ / +
Milk	+ / o	+ / +	+ / +	+ / +	+ / +
Mineral Oil	+ / +	+ / +	+ / +	+ / +	+ / +
Nitric Acid, dilute	- / -	- / -	+ / +	- / -	+ / o
Nitrobenzene	- / -	- / -	+ / +	+ / -	+ / +
Phosphoric Acid, dilute	+ / +	- / -	+ / +	+ / -	o / -
Propanol (IPA)	o / -	+ / +	+ / +	+ / +	o / o
Silver Nitrate	+ / o	o / -	+ / +	+ / -	+ / +
Soaps	+ / +	+ / +	+ / +	+ / +	+ / +
Sodium Hydroxide, dilute	+ / +	o / -	+ / +	+ / +	+ / +
Sulphuric Acid, dilute	o / -	- / -	+ / +	o / -	o / -
Urine	+ / +	+ / +	+ / +	+ / +	+ / +
Vegetable Oil	+ / o	+ / +	+ / +	+ / +	+ / +
Water	+ / +	+ / o	+ / +	+ / +	+ / +
Water, Sea-, Salt-	+ / +	+ / o	+ / +	+ / +	- / -

Above data is intended only as a guide for chemical compatibility.

We do not assume any liability for the accuracy of the information.

It is strongly recommended that users perform their own tests to determine suitability of material.

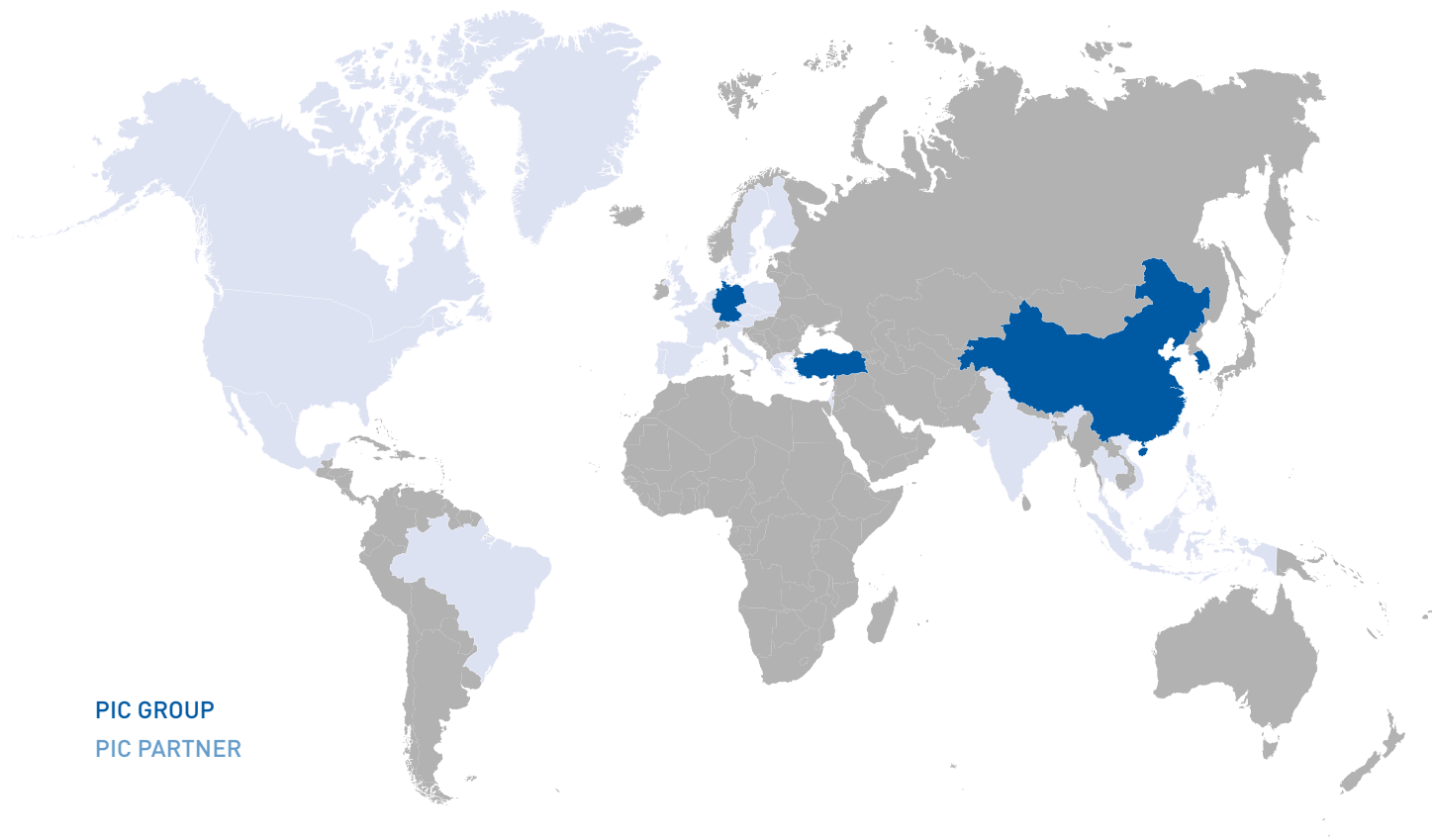

PIC GROUP  
PIC PARTNER

### Production

PIC Sensors Zhuhai Ltd.  
CHINA (PRC)

PIC Sensör Sanayi Tic. Ltd.  
TURKEY

### Sales Office

PIC Sensors Korea Inc.  
SOUTH KOREA

PIC Sensors Asia Ltd.  
HONG KONG (SAR)

### Headquarter

**PIC GmbH**  
Nibelungenstr. 5A  
90530 Wendelstein  
Germany  
Tel. +49 911 995906-0  
Fax +49 911 995906-99  
eMail info@pic-gmbh.com  
www.pic-gmbh.com

© PIC GmbH, 2016

 ERMEC, S.L. BARCELONA  
C/ Francesc Teixidó, 22  
08918 Badalona  
(España)

Tel.: (+34) 902 450 160  
Fax: (+34) 902 433 088  
[info@ermec.com](mailto:info@ermec.com)  
[www.ermec.com](http://www.ermec.com)

ERMEC, S.L. MADRID  
c/Mejorada, 17,1ªPl. Of.D4  
28850 Torrejón de Ardoz  
(España)

PORTUGAL  
[portugal@ermec.com](mailto:portugal@ermec.com)  
BILBAO  
[bilbao@ermec.com](mailto:bilbao@ermec.com)



[pic-gmbh.com](http://pic-gmbh.com)



ERMEC, S.L. BARCELONA  
C/ Francesc Teixidó, 22  
08918 Badalona  
(España)

Tel.: (+34) 902 450 160  
Fax: (+34) 902 433 088  
[info@ermec.com](mailto:info@ermec.com)  
[www.ermec.com](http://www.ermec.com)

ERMEC, S.L. MADRID  
c/Mejorada, 17, 1ªPl. Of.D4  
28850 Torrejón de Ardoz  
(España)

PORTUGAL  
[portugal@ermec.com](mailto:portugal@ermec.com)  
BILBAO  
[bilbao@ermec.com](mailto:bilbao@ermec.com)