

Long overtravel Microswitches

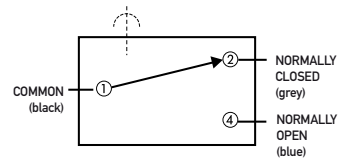

Circuit diagram



Dimensions

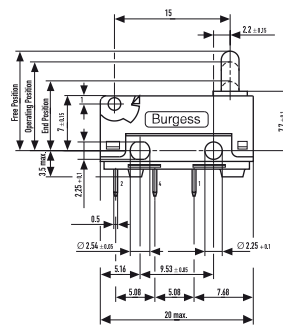

V4L

Characteristics	<ul style="list-style-type: none"> ■ long overtravel of 2.2 mm minimum ■ sealed to (IP6K7) option ■ pre-wired option ■ solder terminals ■ compliant to glow wire test IEC 60335-1, 4. ed. as optional item
Rating	250 VAC, 5 A
Dimensions (mm)	20 × 11 × 6.4
Actuator	<ul style="list-style-type: none"> ■ plunger ■ plain lever ■ ice break lever
Approvals	ENEC, UL, CSA



Preferred Range

Ordering Reference	Actuating Force (N) (ozf)		Sealing	Operating pos. (mm)	Terminal	Circuit	Actuator	Contacts	Electrical rating
V4LS	2.5	9.0	IP6K7	11,7 ± 0,4	Cable 500 mm	CO	Plunger	Ag	250 VAC, 5 A
V4LSA1	2.5	9.0	IP6K7	14,5 ± 0,8	Cable 500 mm	CO	Plain lever	Ag	250 VAC, 5 A
V4LSA2	2.0		IP6K7	16,5 ± 1,0	Cable 500 mm	CO	Plain lever	Ag	250 VAC, 5 A
V4LST7	2.5	9.0	IP6K7	11,7 ± 0,4	Solder	CO	Plunger	Ag	250 VAC, 5 A
V4LST7A1	2.5		IP6K7	14,5 ± 0,8	Solder	CO	Plain lever	Ag	250 VAC, 5 A
V4LST7A2	2.0		IP6K7	14,6 ± 1,0	Solder	CO	Plain lever	Ag	250 VAC, 5 A
V4LT7	2.4	8.6	no symbol	11,7 ± 0,4	Solder	CO	Plunger	Ag	250 VAC, 5 A

Specifications

Housing	Glass fibre reinforced polyamide (PA 6.6)
Plunger	Polyacetal (POM)
Mechanism	Snap-action coil spring mechanism with stainless steel spring. Change-over, normally closed or normally open
Contact carrier	Brass. Moving contact beryllium-copper
Contacts	Fine silver or gold crosspoint
Terminals	V4L – solder tags V4LS – PVC covered leads 0.5 m long
Temperature range °C	-40°C to +85°C
Mechanical life	V4L 2×10^6 cycles/min., V4LS 2×10^5 cycles/min. (impact free actuation)
Protection	V4L series IP40, V4LS series IP6K7, with encapsulated terminals
Mounting	Side mounting to a flat surface
Actuators	Plain lever, Ice break lever
Cowl	Silicon elastomer

Circuit diagram

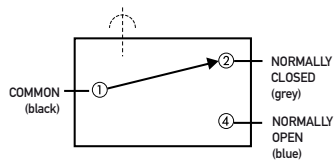

Dimensions

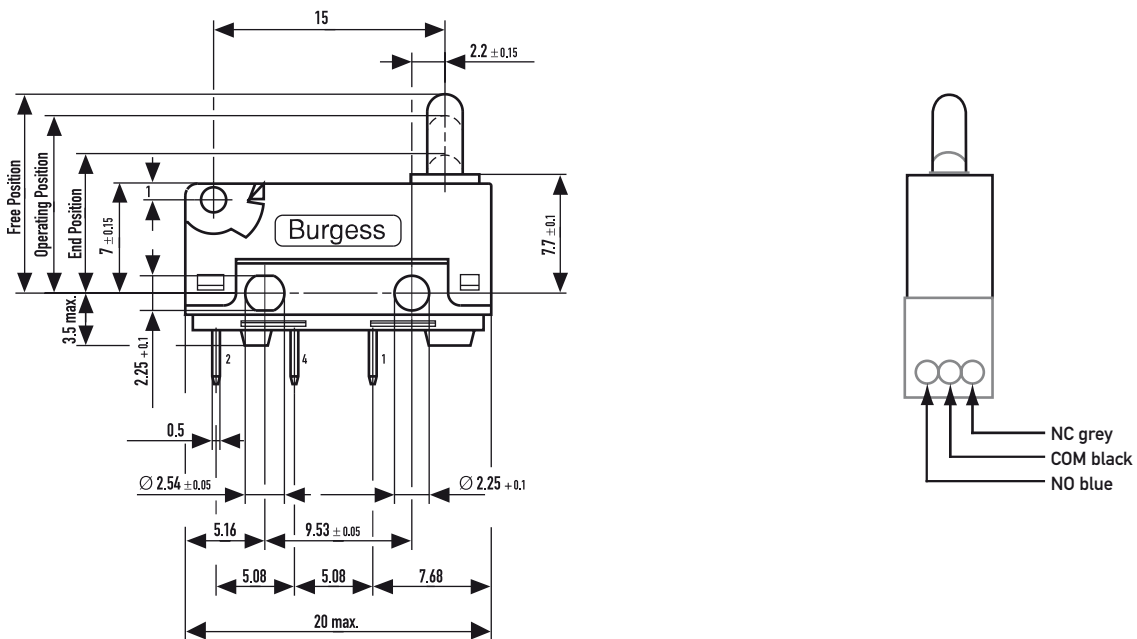

Recommended maximum electrical ratings

Voltage (VAC)	Resistive load (A) (Ag Contact)	Incandescent lamp load (A) (Ni1 Contact)	Inductive load (A) (Ag Contact)	Voltage (VDC) up to	Resistive load (A) (Ag Contact)	Incandescent lamp load (A) (Ni1 Contact)	Inductive load (A) (Ag Contact)
125	5	2	2	30	5	2	3
250	5	2	2	50	1	0.4	1
				75	0.75	0.3	0.75
				125	0.5	0.2	0.03
				250	0.25	0.1	0.03

Ordering Reference

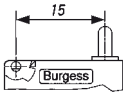
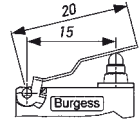
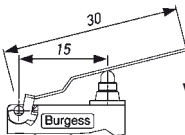
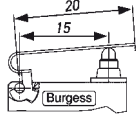
Actuator	Reference	Actuating Force		Release Position		Free Position		Operating		Movement Differential		Total overtravel		Overtravel	
		Maximum (N)	(ozf)	Minimum (N)	(ozf)	Maximum (mm)	(in)	(mm)	(in)	Maximum (mm)	(in)	Minimum (mm)	(in)	Minimum (mm)	(in)
Plunger 	V4LT7	2.4	8.60	0.4	1.44	12.9	0.507	11.7 ± 0.4	0.46 ± 0.012	0.9	0.023	9.2	0.36	2.2	0.09
	V4LST7	2.5	9.00	0.5	1.78	12.9	0.507	11.7 ± 0.4	0.46 ± 0.012	0.9	0.023	9.2	0.36	2.2	0.09
A1 Lever 	V4L...	2.4	8.60	0.4	1.44	14.5	0.57	12.6 ± 0.8	0.59 ± 0.03	1.0	0.04	9.6	0.38	2.2	0.09
	V4LS...	2.5	9.00	0.5	1.78	14.5	0.57	12.6 ± 0.8	0.59 ± 0.03	1.0	0.04	9.6	0.38	2.2	0.09
Width of lever 4.0 mm/0.16 in															
A2 Lever 	V4L...	1.5	5.70	0.3	1.08	16.5	0.65	13.5 ± 1.0	0.53 ± 0.04	1.3	0.05	9.6	0.38	2.9	1.1
	V4LS...	2	7.20	0.3	1.08	16.5	0.65	13.5 ± 1.0	0.53 ± 0.04	1.3	0.05	9.6	0.38	2.9	1.1
Width of lever 4.0 mm/0.16 in															
F Lever 	V4L...	For positions and forces of this actuator please contact Burgess													
	V4LS...														
Width of lever 4.0 mm/0.16 in															

Ordering Reference

Basic type	V4L	Example: V4L	S	T7	C2	A1	G	UL
Type of sealing	No symbol, unsealed S Sealed IP6K7							
Terminals	No symbol, pre-wired 500 mm with cable FLRY 0.5 mm ² and cable box (V4LS only)							
	T7	Solder	2.95 × 0.5 × 3.55 long					
	T8	PCB	0.8 × 0.5 × 4.0 long					
Circuit	No symbol, change over							
	C2	Normally closed						
	C4	Normally open						
Actuators	No symbol, without lever							
	A1	Plain lever	20.0 mm, fitted at the end opposite to plunger					
	A2	Plain lever	30.0 mm, fitted at the end opposite to plunger					
	F	Special lever F type	20.0 mm, fitted at the end opposite to plunger					
Contact Material	No symbol, Ag							
	G	Gold plate on silver (GP)						
	X	Gold alloy on silver palladium crosspoint (AUX)						
	Other contact materials on special request							
Approvals	No symbol, without approval							
	UL	UL and CSA approval						
	EN	ENEC approval only						
	UN	UL, CSA and ENEC approval						
Special Features	/ <input type="checkbox"/> <input type="checkbox"/> <input type="checkbox"/> <input type="checkbox"/>		Burgess specialise in customer specific solutions. Additional product variants are available or can be provided. If your requirements cannot be satisfied from the options listed, please contact www.saia-burgess.com or your local SB outlet.					