

Ledex[®] Low Profile Linear Solenoids

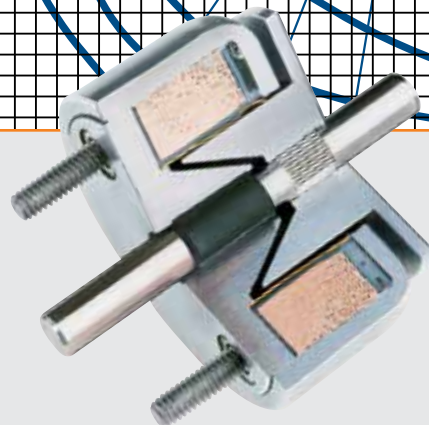

Ledex® Low Profile Solenoids

LINEAR Low Profile

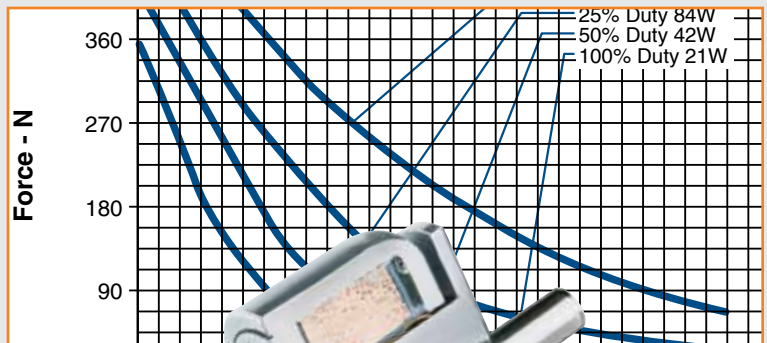

- Linear actuation
- Space-saving, low-profile configuration
- Ideal for high force, short stroke applications
- Forces to 845 N
- Stroke lengths to 18 mm

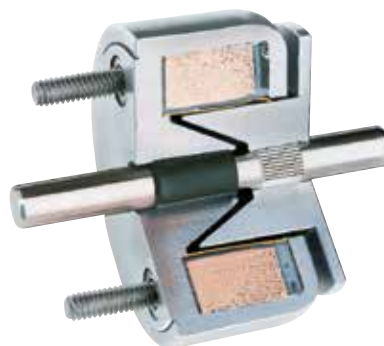

All catalogue products manufactured after April 1, 2006 are RoHS Compliant

The low profile shape, besides contributing to smaller size, optimises the magnetic flux paths for maximum force versus stroke characteristics. The construction of the plunger assembly provides an auxiliary flux path which permits a significant increase in force. The low profile solenoid construction not only provides long life, but also provides a rugged design for both military and commercial applications.

Conical Face vs. Flat Face Plunger Design

Conical-faced designs extend the useful range of a solenoid to provide higher forces for strokes typically over 1.5 mm. The pole surface area is greater and the distance between the tapered cone faces is approximately one-half that of the gap between the land faces (for 30° angles), providing the effect of a closer air gap.

Flat Face: Higher efficiency for shorter strokes

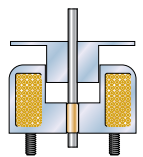

De-Energised

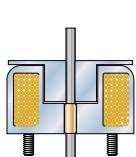

Energised

Conical Face: Higher force for longer strokes

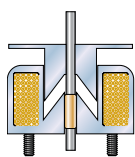

De-Energised

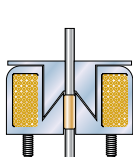

Energised

While some of the force component is lost because the force vector is not parallel with the plunger motion, the shorter gap and higher flux density combine to provide more output force for longer strokes.

For shorter strokes, the magnetic flux density increases and causes the iron to saturate rapidly as the poles move closer, thus reducing the efficiency of the conical-faced design. At this point, the flat-faced plunger is more efficient.

The main advantage of the flat-faced pole over the conical is that the full component of force is usable because the force vector is parallel with the pole motion.

Applications

The reliability and high performance of Low Profile solenoids make them an ideal choice for applications in which consistent, reliable operation is critical.

- Pumps
- Machine tools
- Packaging machines
- Cranes
- Instruments
- Flow controls
- Trucks and buses
- Computer peripherals

Ledex® Low Profile Solenoids

Why Low Profile solenoids provide such high force and rapid response.

A key to the efficiency and compact form factor of the low profile solenoid is our special precision coil-winding process. With maximum copper packed into the allowable space, each solenoid develops tremendous force for its size and power input. The low profile form, in addition to contributing to smaller size, permits maximum pole face surface area for the magnetic flux.

Another factor that contributes to high efficiency is the additional iron surface on the external portion of the plunger; it provides an auxiliary flux path and a significant increase in force.

The force is also affected by other interrelated features, such as the length of the iron path, the magnetic saturation properties of the solenoid case and plunger, and the area and shape of the pole pieces.

The enclosed construction of the solenoid not only provides an iron path with minimum losses at the ring gap, but also provides a rugged design for critical environment applications

Performance Curves

The performance curves in this section serve as guides to determine the solenoid size needed to produce a desired force at a given stroke, duty cycle, and power source. All curves were developed under the following standard test conditions: ambient temperature of 20°C, 65% relative humidity.

Starting Force

When determining an application's force requirement, apply a 1.5 safety factor. For example: a load requiring 1.0 N of force should utilise a solenoid providing 1.0 N x 1.5 or 1.5 N of force.

Duty Cycle

Duty cycle is determined by: ON time/(ON + OFF time).

For example: a solenoid is actuated for 30 seconds, then off for 90 seconds.
 $30 \text{ sec ON} / (30 \text{ Sec ON} + 90 \text{ sec OFF}) = 30/120 = 1/4 \text{ or } 25\% \text{ duty cycle.}$

Ledex Low Profile solenoids are rated for various duty cycles ranging from continuous to 10% duty.

Note that maximum ON time for a particular application can be a factor which overrides the duty cycle rating. For example, at 25% duty cycle, the maximum ON time for a given Ledex solenoid is 36 seconds. If, however, the solenoid is operated at a cycle rate which enables the unit to return to ambient temperature between ON cycles, then the maximum ON time is extended somewhat. In the above example, this extended ON time is 44 seconds. Maximum ON time ratings are listed on the individual model specification pages.

Typical Examples of Custom Features

Even though many solenoid designs are in stock, our customers often require a product with unique features or performance capabilities. So, if you don't find what you're looking for in the catalogue, give us a call to discuss your needs with one of our application engineers.

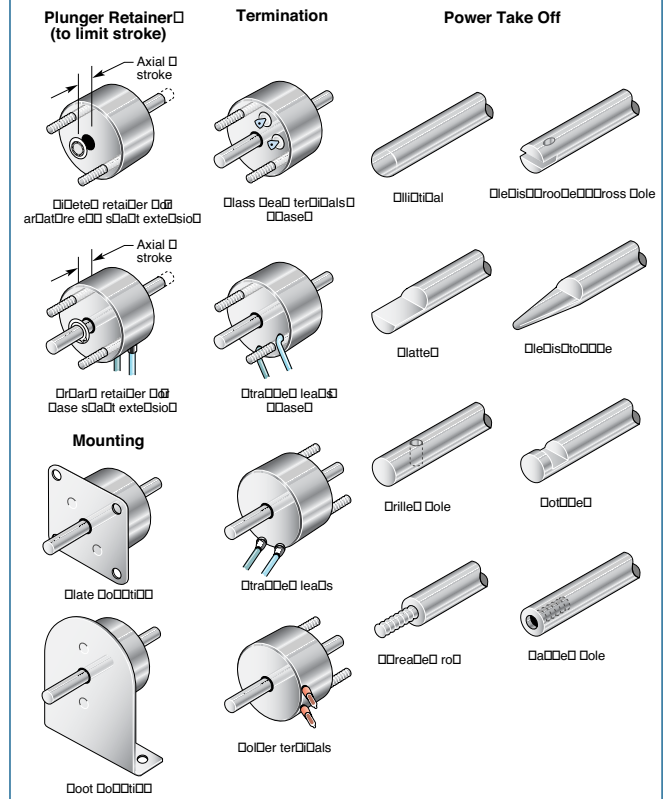

Life

When selecting a Low Profile solenoid, as with any other solenoid style, it is important to consider factors that will affect the life of the unit. Heat, side-loading, stroke and operating environment all play an important role in determining the life you can expect in your application.

A simple, yet often overlooked method to improve Low Profile solenoid life is to minimise the side load. Maximum life can be achieved by mounting Low Profile solenoids so that the shaft travels along a vertical plane. Keeping the stroke as short as possible will also improve life.

Power Requirements

Voltage applied to the solenoid must be matched to the coil wire size for proper operation. Solenoids are catalogued in coil awgs ranging from #25 up to #38 to accommodate your input power. Refer to the individual model specification pages for coil wire awg recommendations. Many other coil awg sizes are available. Please feel free to contact our application engineering department for availability.

Ledex® Low Profile Selection

Low Profile solenoids are available in nine sizes. Use the selection chart to determine which size offers the desired performance and mechanical specifications. Refer to the individual size specification pages for complete performance and mechanical data.

All catalogue products manufactured after April 1, 2006 are RoHS Compliant

Low Profile Selection Overview

Size*	Package Dimensions (mm)		Max Stroke (mm)	Nominal Stroke (mm)	Force (N) @ Nominal Stroke at Specified Duty Cycle @ 20°C			
	Dia.	Length			100%	50%	25%	10%
0ECM ●	19.0	12.7	3.81	1.5	0.9	2.0	3.8	9.2
1ECM ●	25.4	13.5	6.10	2.0	1.1	2.2	5.6	14.2
2EFM	28.6	14.7	1.78	0.8	8.9	15.6	28.9	60.0
2ECM ●	28.6	14.7	6.10	2.5	1.1	4.5	8.9	16.7
3EFM	33.3	17.5	1.78	1.0	11.1	22.3	49.0	89.0
3ECM	33.3	17.5	7.62	3.1	3.6	8.9	16.9	24.9
4EFM	39.7	21.2	3.04	1.5	13.4	28.9	53.4	111.3
4ECM	39.7	21.2	6.35	3.8	4.5	10.0	24.5	51.2
5SFM	47.6	22.4	3.56	2.0	13.4	42.3	75.7	173.6
5ECM	47.6	26.3	10.16	5.1	11.1	22.3	44.5	93.5
6SFM	57.2	29.1	4.57	2.0	44.5	89.0	178.0	356.0
6ECM	57.2	33.8	10.16	5.1	26.7	57.9	106.8	191.4
7ECM	69.9	44.5	17.78	7.6	40.1	80.1	146.9	240.3
8ECM	85.7	55.0	17.78	7.6	120.2	231.4	400.5	645.2

● Well-suited for battery operation.



See the "Battery Operated Solenoids" section for complete information.

All data is at 20°C coil temperature. Force outputs degrade with elevated temperatures.

* EC sizes have conical face plungers, EF and SF sizes have flat face plungers.

LINEAR Low Profile

How to Use Low Profile Performance Charts

- Select one of the four columns which provides the appropriate duty cycle. (For example 50%.)
- Reading down this column provides a variety of performance and electrical data including maximum on time, watts, and amp turns.
- Following down the column further into the VDC ratings, select the voltage which most closely matches your supply voltage. (For example, 8.9 for a 9 VDC power supply.)
- Read across (to the left) to select the awg suffix to complete the part number when ordering. (In this example using our 0EC chart, 32 awg is required, thus to order, specify: 282340-032.)

Performance

	100%	50%	25%	10%
Maximum Duty Cycle	∞	100	36	7
Maximum ON Time (sec) when pulsed continuously	∞	162	44	8
Maximum ON Time (sec) for single pulse	4.5	9	18	45
Watts (@ 20°C)	28.5	403	570	901

Coil Data

awg (OXX)	Resistance (@20°C)	# Turns	VDC (Nom)	VDC (Nom)	VDC (Nom)	VDC (Nom)
26	0.50	90	1.6	2.3	3.2	5.1
27	0.97	136	2.0	2.8	3.9	6.3
28	1.33	152	2.6	3.7	5.1	8.1
29	2.40	215	3.2	4.4	6.2	9.9
30	3.29	240	4.1	5.7	8.0	12.7
31	5.61	324	5.0	7.1	9.9	15.8
32	9.09	420	6.3	8.9	12.4	19.7
33	14.95	544	8.0	11.3	15.7	25.0
34	24.06	684	10.2	14.4	20.0	32.0
35	37.10	840	12.8	18.1	25.0	40.0
36	58.51	1056	16.1	23.0	32.0	50.0
37	78.70	1109	19.8	28.0	39.0	62.0
38	123.00	1370	25.0	35.0	49.0	78.0

ERMEC

www.ermec.com

Distribución de componentes eléctricos y electrónicos

Force values for reference only.

All specifications subject to change without notice.

Ledex® Low Profile Size OECM — Push or Pull

Medium Stroke, Conical Face
Part Number: 282340-0XX

All catalogue products manufactured after April 1, 2006 are RoHS Compliant

Performance

Maximum Duty Cycle	100%	50%	25%	10%
Maximum ON Time (sec) when pulsed continuously ¹	∞	100	36	7
Maximum ON Time (sec) for single pulse ²	∞	162	44	8
Watts (@ 20°C)	4.5	9	18	45
Ampere Turns (@ 20°C)	285	403	570	901

Coil Data			VDC	VDC	VDC	VDC
awg (0XX) ³	Resistance (@20°C)	# Turns ⁴	(Nom)	(Nom)	(Nom)	(Nom)
26	0.50	90	1.6	2.3	3.2	5.1
27	0.97	136	2.0	2.8	3.9	6.3
28	1.33	152	2.6	3.7	5.1	8.1
29	2.40	215	3.2	4.4	6.2	9.9
30	3.29	240	4.1	5.7	8.0	12.7
31	5.61	324	5.0	7.1	9.9	15.8
32	9.09	420	6.3	8.9	12.4	19.7
33	14.95	544	8.0	11.3	15.7	25.0
34	24.06	684	10.2	14.4	20.0	32.0
35	37.10	840	12.8	18.1	25.0	40.0
36	58.51	1056	16.1	23.0	32.0	50.0
37	78.70	1109	19.8	28.0	39.0	62.0
38	123.00	1370	25.0	35.0	49.0	78.0

- ¹ Continuously pulsed at stated watts and duty cycle
- ² Single pulse at stated watts (with coil at ambient room temperature 20°C)
- ³ Other coil awg sizes available — please consult factory
- ⁴ Reference number of turns

Specifications

Dielectric Strength	1000 VRMS
Recommended Minimum Heat Sink	Maximum watts dissipated by solenoid are based on an unrestricted flow of air at 20°C, with solenoid mounted on the equivalent of an aluminium plate measuring 51 mm square by 3.2 mm thick
Coil Resistance	±10% tolerance on all coil awg sizes
Weight	24.8 g
Holding Force	7.6 N @ 105°C
Dimensions	See page G16

How to Order

Add the coil awg number (0XX) to the part number (for example: to order a 25% duty cycle unit rated at 3.2 VDC, specify 282340-026).

Please see www.ledex.com (click on Stock Products tab) for our list of stock products available through our distributors.

- Well-suited for battery operation. See the "Battery Operated Solenoids" section for complete information.

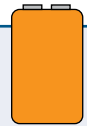

LINEAR Low Profile

Size OECM — Typical Force @ 20°C

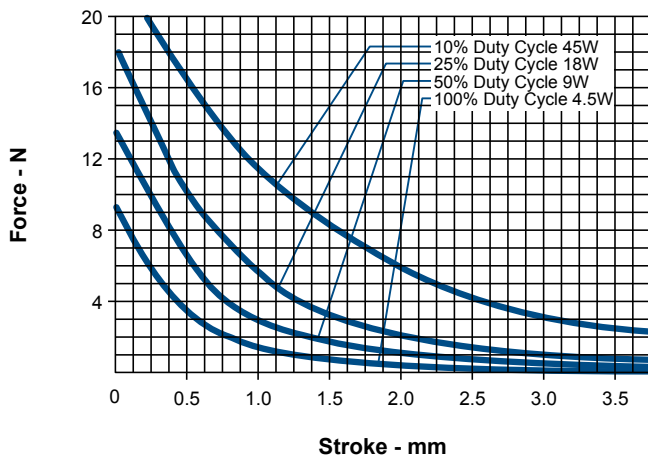

Force values for reference only.

Size OECM — Typical Speed @ No Load, 20°C

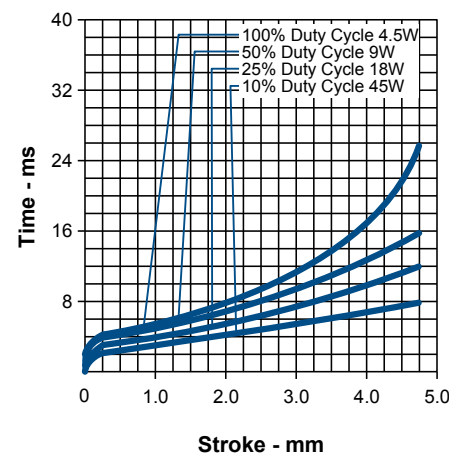

All specifications subject to change without notice.

Ledex® Low Profile Size 1ECM — Push or Pull

Medium Stroke, Conical Face
Part Number: 282342-0XX

All catalogue products manufactured after
April 1, 2006 are RoHS Compliant

Performance

Maximum Duty Cycle	100%	50%	25%	10%
Maximum ON Time (sec) when pulsed continuously ¹	∞	100	36	7
Maximum ON Time (sec) for single pulse ²	∞	162	44	8
Watts (@ 20°C)	5	10	20	50
Ampere Turns (@ 20°C)	340	480	680	1075

Coil Data

avg (0XX) ³	Resistance (@20°C)	# Turns ⁴	VDC (Nom)	VDC (Nom)	VDC (Nom)	VDC (Nom)
25	0.83	140	2.1	2.9	4.1	6.5
26	1.38	186	2.6	3.7	5.2	8.2
27	1.91	210	3.2	4.5	6.3	10.1
28	3.17	273	4.1	5.7	8.1	12.8
29	5.17	352	5.1	7.2	10.2	16.2
30	8.25	441	6.5	9.2	13.0	21.0
31	12.95	550	8.2	11.6	16.4	26.0
32	20.71	682	10.6	14.9	21.0	34.0
33	30.60	828	12.7	18.2	26.0	41.0
34	50.95	1078	16.5	23.0	33.0	52.0
35	83.92	1392	21.0	30.0	42.0	67.0
36	112.00	1500	26.0	37.0	52.0	83.0

- Continuously pulsed at stated watts and duty cycle
- Single pulse at stated watts (with coil at ambient room temperature 20°C)
- Other coil avg sizes available — please consult factory
- Reference number of turns

Specifications

Dielectric Strength	1000 VRMS
Recommended Minimum Heat Sink	Maximum watts dissipated by solenoid are based on an unrestricted flow of air at 20°C, with solenoid mounted on the equivalent of an aluminium plate measuring 76 mm square by 3.2 mm thick
Coil Resistance	25-35 awg, ±5%; 36 awg, ±10%
Weight	42.5 g
Holding Force	24.0 N @ 105°C
Dimensions	See page G16

How to Order

Add the coil awg number (0XX) to the part number (for example: to order a 25% duty cycle unit rated at 6.3 VDC, specify 282342-027).

Please see www.ledex.com (click on Stock Products tab) for our list of stock products available through our distributors.

LINEAR Low Profile

- Well-suited for battery operation. See the "Battery Operated Solenoids" section for complete information.



Size 1ECM — Typical Force @ 20°C

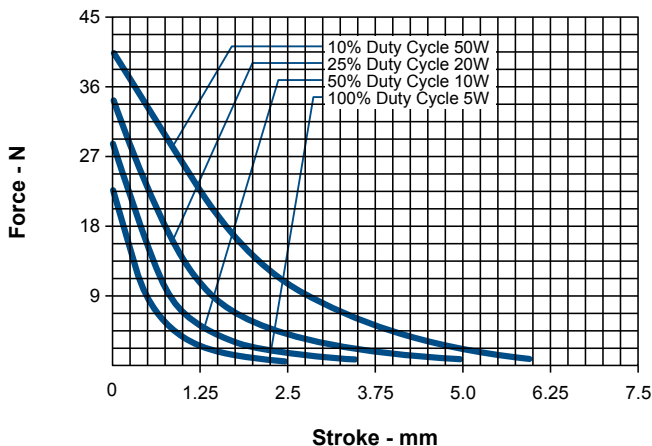

Force values for reference only.

Size 1ECM— Typical Speed @ No Load, 20°C

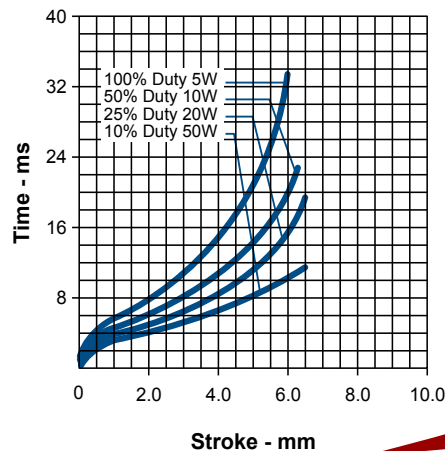

All specifications subject to change without notice.



Ledex® Low Profile Size 2EFM/2ECM — Push or Pull

Size 2EFM Short Stroke, Flat Face

Part Number: 282343-0XX

Size 2ECM • Medium Stroke, Conical Face

Part Number: 282344-0XX

All catalogue products manufactured after April 1, 2006 are RoHS Compliant

Performance

Maximum Duty Cycle	100%	50%	25%	10%
Maximum ON Time (sec) when pulsed continuously ¹	∞	100	36	7
Maximum ON Time (sec) for single pulse ²	∞	162	44	8
Watts (@ 20°C)	7	14	28	70
Ampere Turns (@ 20°C)	425	602	849	1350

Coil Data

awg (0XX) ³	Resistance (@20°C)	# Turns ⁴	VDC (Nom)	VDC (Nom)	VDC (Nom)	VDC (Nom)
24	0.68	130	2.2	3.2	4.5	7.1
25	1.16	174	2.8	4.0	5.7	9.0
26	1.96	231	3.6	5.1	7.2	11.5
27	3.16	296	4.5	6.4	9.0	14.4
28	5.10	378	5.7	8.1	11.5	18.2
29	6.94	423	7.0	9.9	13.9	22.0
30	11.03	530	8.8	12.5	17.7	28.0
31	16.85	649	11.0	15.6	22.0	35.0
32	28.15	858	13.9	19.8	28.0	44.0
33	42.75	1036	17.5	25.0	35.0	56.0

- ¹ Continuously pulsed at stated watts and duty cycle
- ² Single pulse at stated watts (with coil at ambient room temperature 20°C)
- ³ Other coil awg sizes available — please consult factory
- ⁴ Reference number of turns

• Well-suited for battery operation. See the "Battery Operated Solenoids" section for complete information.



Specifications

Dielectric Strength	1000 VRMS
Recommended Minimum Heat Sink	Maximum watts dissipated by solenoid are based on an unrestricted flow of air at 20°C, with solenoid mounted on the equivalent of an aluminium plate measuring 86 mm square by 3.2 mm thick
Coil Resistance	24-33 awg, ±5%
Weight	63.8 g
Holding Force 2EF	53.4 N @ 105°C
Holding Force 2EC	25.4 N @ 105°C
Dimensions	See page G16

How to Order

Add the coil awg number (0XX) to the part number (for example: to order a 25% duty cycle unit rated at 9.0 VDC, specify 282343-027).

Please see www.ledex.com (click on Stock Products tab) for our list of stock products available through our distributors.

Size 2EFM and 2ECM – Typical Speed @ No Load, 20°C

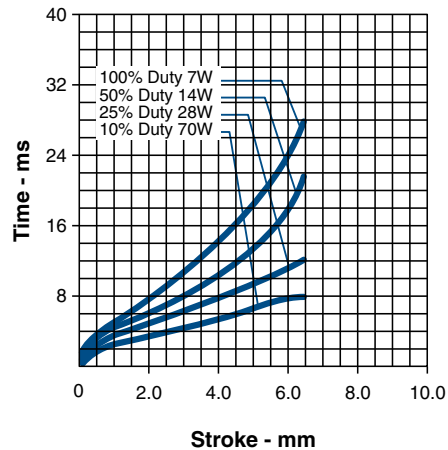

Size 2EFM— Typical Force @ 20°C

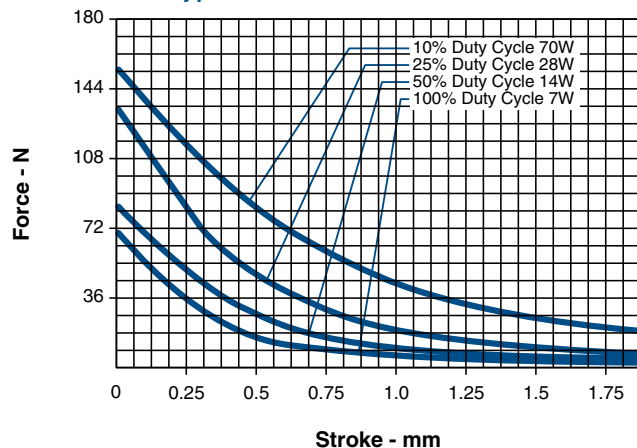

Force values for reference only.

Size 2ECM — Typical Force @ 20°C

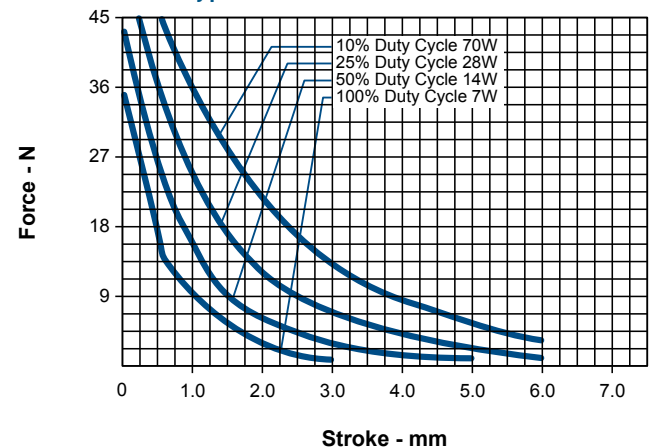

All specifications subject to change without notice.

Ledex® Low Profile Size 3EFM/3ECM — Push or Pull

Size 3EFM Short Stroke, Flat Face

Part Number: 282345-0XX

Size 3ECM Medium Stroke, Conical Face

Part Number: 282346-0XX

Performance

Maximum Duty Cycle	100%	50%	25%	10%
Maximum ON Time (sec) when pulsed continuously ¹	∞	100	36	8
Maximum ON Time (sec) for single pulse ²	∞	162	44	9
Watts (@ 20°C)	9	18	36	90
Ampere Turns (@ 20°C)	535	756	1070	1690

Coil Data

awg (0XX) ³	Resistance (@20°C)	# Turns ⁴	VDC (Nom)	VDC (Nom)	VDC (Nom)	VDC (Nom)
23	0.70	145	2.6	3.7	5.2	8.2
24	1.18	192	3.3	4.6	6.6	10.4
25	1.97	252	4.2	5.9	8.4	13.2
26	3.26	328	5.3	7.5	10.6	16.8
27	5.04	405	6.7	9.4	13.3	21.0
28	8.02	510	8.4	11.9	16.8	27.0
29	12.21	627	10.4	14.7	21.0	33.0
30	19.20	780	13.2	18.6	26.0	42.0
31	31.84	1008	16.9	24.0	34.0	53.0
32	46.97	1215	21.0	29.0	41.0	65.0
33	75.30	1530	26.0	37.0	53.0	83.0

- Continuously pulsed at stated watts and duty cycle
- Single pulse at stated watts (with coil at ambient room temperature 20°C)
- Other coil awg sizes available — please consult factory
- Reference number of turns

All catalogue products manufactured after April 1, 2006 are RoHS Compliant

Specifications

Dielectric Strength	23-27 awg, 1000 VRMS ; 28-33 awg, 1200 VRMS
Recommended Minimum Heat Sink	Maximum watts dissipated by solenoid are based on an unrestricted flow of air at 20°C, with solenoid mounted on the equivalent of an aluminium plate measuring 118 mm square by 3.2 mm thick
Coil Resistance	23-33 awg, ±5%
Weight	106.3 g
Holding Force 3EF	115.6 N @ 105°C
Holding Force 3EC	53.4 N @ 105°C
Dimensions	See page G16

How to Order

Add the coil awg number (0XX) to the part number (for example: to order a 25% duty cycle unit rated at 13.3 VDC, specify 282345-027).

Please see www.ledex.com (click on Stock Products tab) for our list of stock products available through our distributors.

Size 3EFM and 3ECM – Typical Speed @ No Load, 20°C

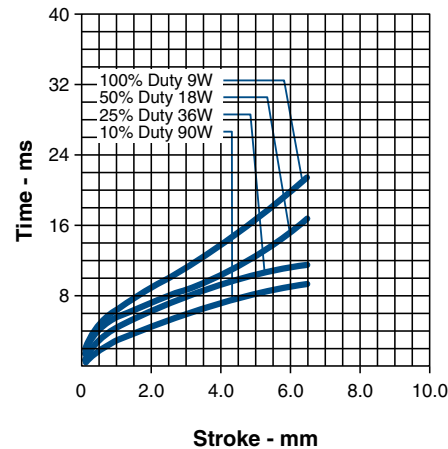

Size 3EFM— Typical Force @ 20°C

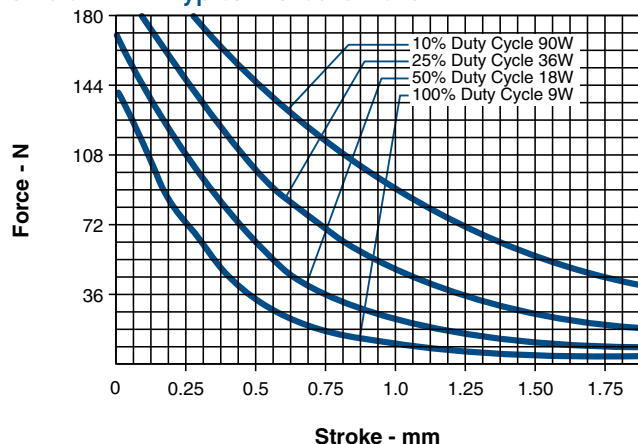

Force values for reference only.

Size 3ECM— Typical Force @ 20°C

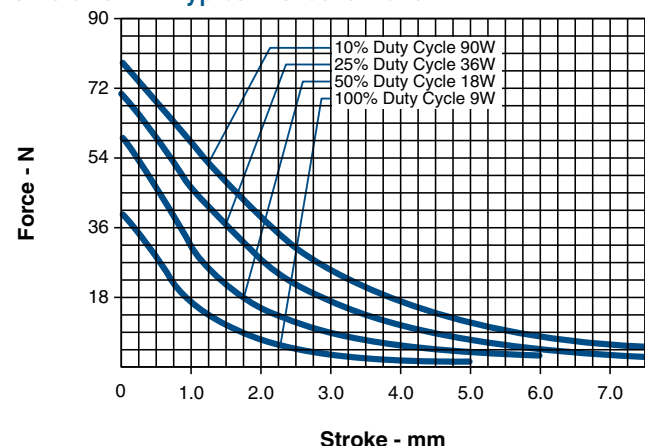

All specifications subject to change without notice.

Ledex® Low Profile Size 4EFM/4ECM — Push or Pull

Size 4EFM Short Stroke, Flat Face

Part Number: 282347-0XX

Size 4ECM Medium Stroke, Conical Face

Part Number: 282348-0XX

All catalogue products manufactured after April 1, 2006 are RoHS Compliant

Performance

Maximum Duty Cycle	100%	50%	25%	10%
Maximum ON Time (sec) when pulsed continuously ¹	∞	100	36	9
Maximum ON Time (sec) for single pulse ²	∞	162	44	10
Watts (@ 20°C)	12.5	25	50	125
Ampere Turns (@ 20°C)	714	1000	1425	2250

Coil Data

awg (0XX) ³	Resistance (@20°C)	# Turns ⁴	VDC (Nom)	VDC (Nom)	VDC (Nom)	VDC (Nom)
23	1.59	266	4.3	6.0	8.5	13.4
24	2.20	301	5.2	7.3	10.4	16.4
25	3.54	384	6.6	9.2	13.1	21.0
26	5.67	486	8.3	11.7	16.6	26.0
27	8.76	600	10.4	14.6	21.0	33.0
28	13.80	748	13.2	18.5	26.0	42.0
29	22.60	975	16.6	23.0	33.0	52.0
30	34.80	1190	21.0	29.0	42.0	66.0
31	56.70	1520	27.0	37.0	53.0	84.0
32	88.30	1908	33.0	46.0	66.0	104.0
33	138.00	2360	42.0	59.0	83.0	132.0

- Continuously pulsed at stated watts and duty cycle
- Single pulse at stated watts (with coil at ambient room temperature 20°C)
- Other coil awg sizes available — please consult factory
- Reference number of turns

Specifications

Dielectric Strength	23-24 awg, 1000 VRMS ; 25-33 awg, 1200 VRMS
Recommended Minimum Heat Sink	Maximum watts dissipated by solenoid are based on an unrestricted flow of air at 20°C, with solenoid mounted on the equivalent of an aluminium plate measuring 159 mm square by 3.2 mm thick
Coil Resistance	23-33 awg, ±5%
Weight	170 g
Holding Force 4EF	164.6 N @ 105°C
Holding Force 4EC	71.2 N @ 105°C
Dimensions	See page G17

How to Order

Add the coil awg number (0XX) to the part number (for example: to order a 25% duty cycle unit rated at 21 VDC, specify 282347-027).

Please see www.ledex.com (click on Stock Products tab) for our list of stock products available through our distributors.

Size 4EFM and 4ECM—Typical Speed @ No Load, 20°C

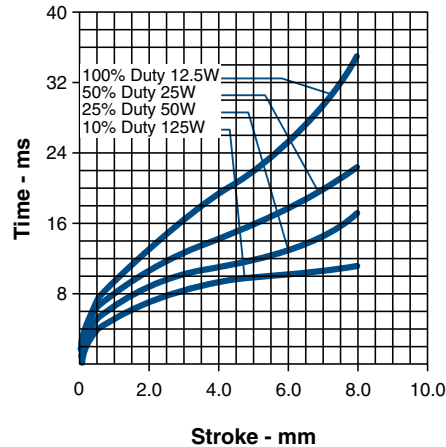

Distribución de componentes eléctricos y electrónicos

Size 4EFM— Typical Force @ 20°C

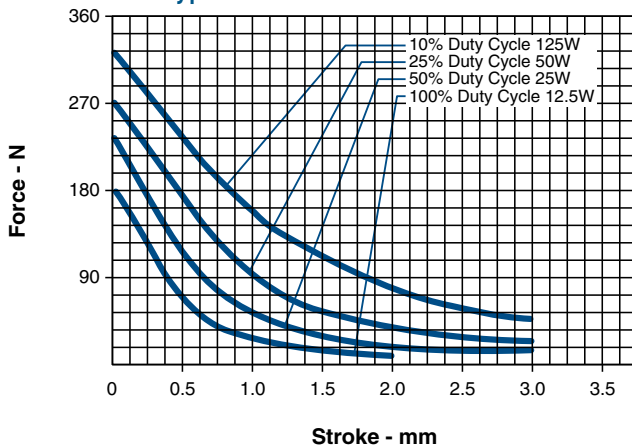

Force values for reference only.

Size 4ECM— Typical Force @ 20°C

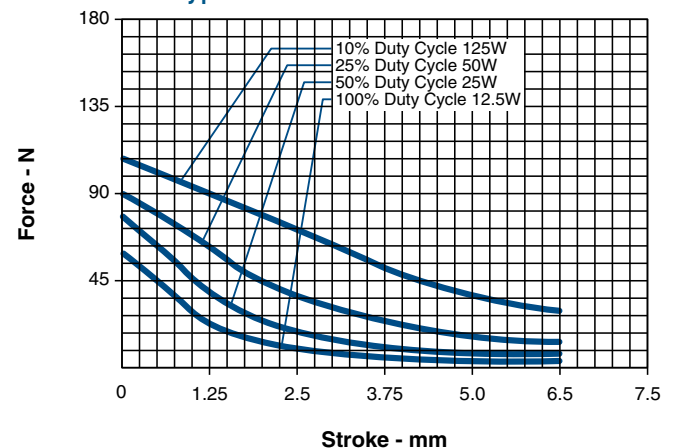

All specifications subject to change without notice.

LINEAR Low Profile

Ledex® Low Profile Size 5SFM — Push or Pull

Short Stroke, Flat Face
Part Number: 282349-0XX

All catalogue products manufactured after
April 1, 2006 are RoHS Compliant

Performance

Maximum Duty Cycle	100%	50%	25%	10%
Maximum ON Time (sec) when pulsed continuously ¹	∞	100	36	10
Maximum ON Time (sec) for single pulse ²	∞	160	44	13
Watts (@ 20°C)	21	42	84	210
Ampere Turns (@ 20°C)	860	1220	1720	2730

Coil Data

awg (0XX) ³	Resistance (@20°C)	# Turns ⁴	VDC (Nom)	VDC (Nom)	VDC (Nom)	VDC (Nom)
23	2.03	288	6.1	8.6	12.1	19.2
24	3.20	360	7.6	10.8	15.3	24.0
25	4.91	440	9.6	13.6	19.2	31.0
26	7.72	550	12.1	17.1	24.0	38.0
27	11.12	636	15.0	21.0	30.0	48.0
28	18.79	840	19.2	27.0	39.0	61.0
29	30.48	1088	24.0	34.0	48.0	77.0
30	44.86	1275	30.0	43.0	61.0	96.0
31	70.90	1596	38.0	54.0	76.0	121.0
32	109.00	1974	47.0	67.0	95.0	150.0
33	175.00	2496	60.0	86.0	121.0	192.0

- ¹ Continuously pulsed at stated watts and duty cycle
- ² Single pulse at stated watts (with coil at ambient room temperature 20°C)
- ³ Other coil awg sizes available — please consult factory
- ⁴ Reference number of turns

Specifications

Dielectric Strength	23 awg, 1000 VRMS ; 24-33 awg, 1200 VRMS
Recommended Minimum Heat Sink	Maximum watts dissipated by solenoid are based on an unrestricted flow of air at 20°C, with solenoid mounted on the equivalent of an aluminium plate measuring 191 mm square by 3.2 mm thick
Coil Resistance	23-33 awg, ±5%
Weight	255 g
Holding Force	258.0 N @ 105°C
Dimensions	See page G17

How to Order

Add the coil awg number (0XX) to the part number (for example: to order a 25% duty cycle unit rated at 50 VDC, specify 282349-027).

Please see www.ledex.com (click on Stock Products tab) for our list of stock products available through our distributors.

LINEAR Low Profile



Size 5SFM— Typical Force @ 20°C

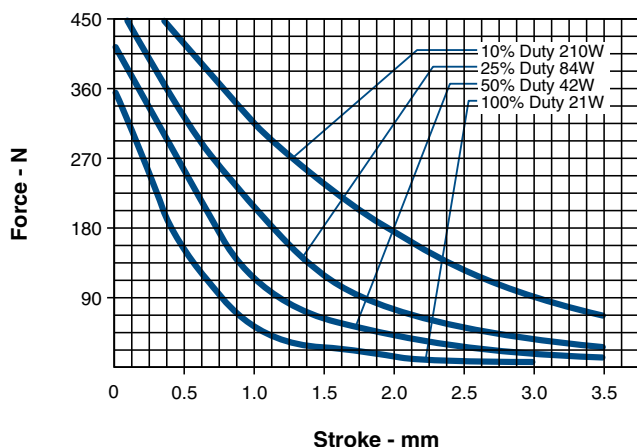

Force values for reference only.

Size 5SFM— Typical Speed @ No Load, 20°C

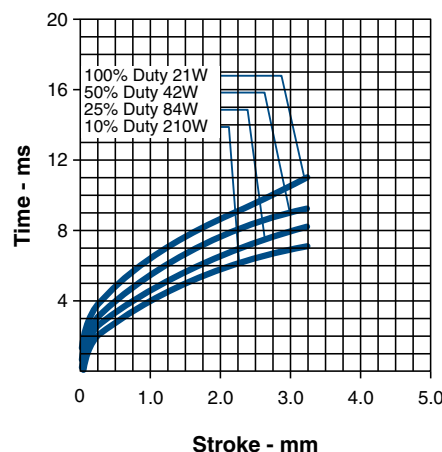

All specifications subject to change without notice.

Ledex® Low Profile Size 5ECM — Push or Pull

Medium Stroke, Conical Face
Part Number: 282350-0XX

All catalogue products manufactured after April 1, 2006 are RoHS Compliant

Performance

Maximum Duty Cycle	100%	50%	25%	10%
Maximum ON Time (sec) when pulsed continuously ¹	∞	100	36	10
Maximum ON Time (sec) for single pulse ²	∞	160	44	13
Watts (@ 20°C)	21	42	84	210
Ampere Turns (@ 20°C)	1015	1440	2030	3210

Coil Data

awg (0XX) ³	Resistance (@20°C)	# Turns ⁴	VDC (Nom)	VDC (Nom)	VDC (Nom)	VDC (Nom)
23	2.70	384	7.2	10.1	14.3	23.0
24	4.30	486	9.0	12.7	18.0	28.0
25	6.66	590	11.5	16.2	23.0	36.0
26	10.30	737	14.0	20.0	28.0	44.0
27	15.70	900	17.7	25.0	35.0	56.0
28	26.60	1190	23.0	32.0	45.0	72.0
29	38.00	1380	28.0	40.0	56.0	89.0
30	62.10	1768	36.0	51.0	71.0	113.0
31	96.10	2166	45.0	64.0	90.0	143.0
32	157.00	2816	57.0	80.0	113.0	179.0
33	241.00	3432	71.0	101.0	143.0	226.0

- ¹ Continuously pulsed at stated watts and duty cycle
- ² Single pulse at stated watts (with coil at ambient room temperature 20°C)
- ³ Other coil awg sizes available — please consult factory
- ⁴ Reference number of turns

Specifications

Dielectric Strength	23 awg, 1000 VRMS ; 24-33 awg, 1200 VRMS
Recommended Minimum Heat Sink	Maximum watts dissipated by solenoid are based on an unrestricted flow of air at 20°C, with solenoid mounted on the equivalent of an aluminium plate measuring 191 mm square by 3.2 mm thick
Coil Resistance	23-33 awg, ±5%
Weight	326.0 g
Holding Force	120.1 N @ 105°C
Dimensions	See page G17

How to Order

Add the coil awg number (0XX) to the part number (for example: to order a 25% duty cycle unit rated at 35 VDC, specify 282350-027).

Please see www.ledex.com (click on Stock Products tab) for our list of stock products available through our distributors.

LINEAR Low Profile

Size 5ECM— Typical Force @ 20°C

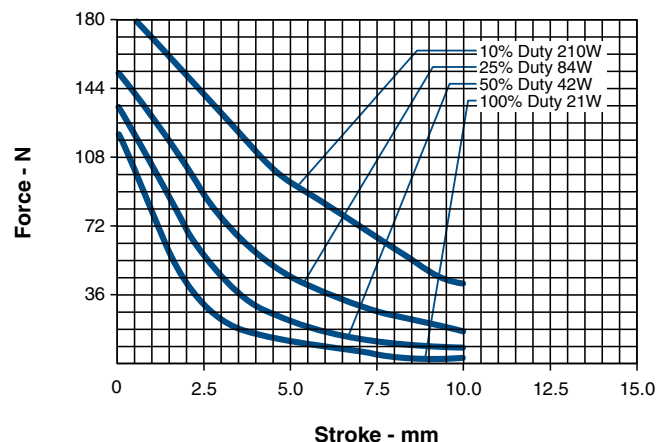

Force values for reference only.

Size 5ECM— Typical Speed @ No Load, 20°C

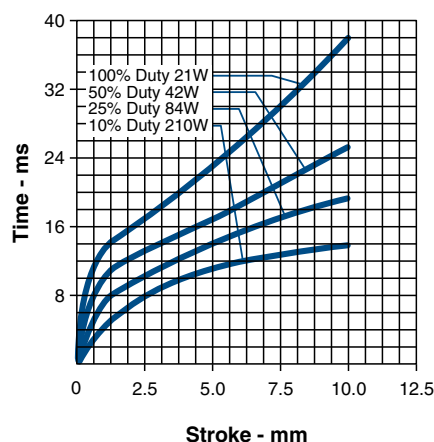

All specifications subject to change without notice.

Ledex® Low Profile Size 6SFM — Push or Pull

Short Stroke, Flat Face
Part Number: 282351-0XX

All catalogue products manufactured after
April 1, 2006 are RoHS Compliant

Performance

Maximum Duty Cycle	100%	50%	25%	10%
Maximum ON Time (sec) when pulsed continuously ¹	∞	87	36	13
Maximum ON Time (sec) for single pulse ²	∞	140	44	16
Watts (@ 20°C)	32	64	128	320
Ampere Turns (@ 20°C)	1240	1760	2490	3920

Coil Data

avg (0XX) ³	Resistance (@20°C)	# Turns ⁴	VDC (Nom)	VDC (Nom)	VDC (Nom)	VDC (Nom)
23	3.59	432	10.3	14.6	21.0	33.0
24	5.24	500	13.0	18.4	26.0	41.0
25	9.51	708	16.7	24.0	33.0	53.0
26	14.44	858	21.0	30.0	42.0	66.0
27	23.69	1110	27.0	38.0	53.0	84.0
28	38.27	1411	34.0	48.0	68.0	106.0
29	54.62	1638	41.0	59.0	83.0	131.0
30	93.67	2184	53.0	76.0	107.0	168.0
31	143.00	2645	67.0	95.0	134.0	211.0
32	223.00	3328	83.0	118.0	167.0	262.0
33	338.00	4004	105.0	149.0	210.0	331.0

- ¹ Continuously pulsed at stated watts and duty cycle
- ² Single pulse at stated watts (with coil at ambient room temperature 20°C)
- ³ Other coil awg sizes available — please consult factory
- ⁴ Reference number of turns

Specifications

Dielectric Strength	23-31 awg, 1200 VRMS ; 32-33 awg, 1500 VRMS
Recommended Minimum Heat Sink	Maximum watts dissipated by solenoid are based on an unrestricted flow of air at 20°C, with solenoid mounted on the equivalent of an aluminium plate measuring 314 mm square by 3.2 mm thick
Coil Resistance	23-33 awg, ±5%
Weight	510.3 g
Holding Force	391.4 N @ 105°C
Dimensions	See page G18

How to Order

Add the coil awg number (0XX) to the part number (for example: to order a 25% duty cycle unit rated at 55 VDC, specify 282351-027).

Please see www.ledex.com (click on Stock Products tab) for our list of stock products available through our distributors.

LINEAR Low Profile



Size 6SFM— Typical Force @ 20°C

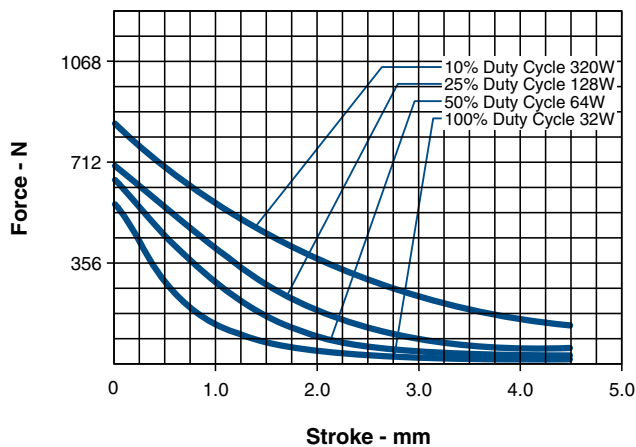

Force values for reference only.

Size 6SFM— Typical Speed @ No Load, 20°C

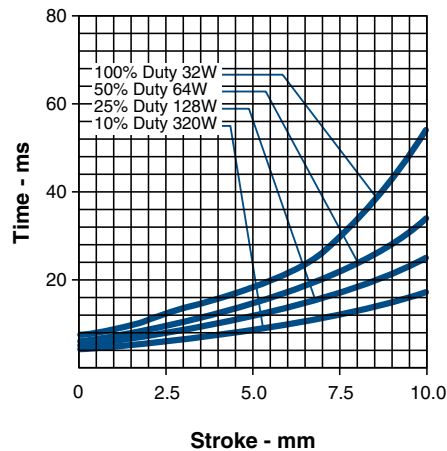

All specifications subject to change without notice.

Ledex® Low Profile Size 6ECM — Push or Pull

Medium Stroke, Conical Face
Part Number: 282352-0XX

All catalogue products manufactured after April 1, 2006 are RoHS Compliant

Performance

Maximum Duty Cycle	100%	50%	25%	10%
Maximum ON Time (sec) when pulsed continuously ¹	∞	87	36	13
Maximum ON Time (sec) for single pulse ²	∞	140	44	16
Watts (@ 20°C)	32	64	128	320
Ampere Turns (@ 20°C)	1480	2080	2940	4620

Coil Data			VDC	VDC	VDC	VDC
awg (0XX) ³	Resistance (@20°C)	# Turns ⁴	(Nom)	(Nom)	(Nom)	(Nom)
23	4.69	567	12.3	17.2	24.0	38.0
24	7.43	710	15.5	22.0	31.0	48.0
25	12.90	960	19.9	28.0	39.0	62.0
26	19.70	1170	25.0	35.0	49.0	78.0
27	32.00	1500	32.0	44.0	63.0	99.0
28	51.60	1904	40.0	56.0	79.0	125.0
29	74.40	2232	49.0	69.0	98.0	154.0
30	126.00	2940	63.0	89.0	126.0	198.0
31	195.00	3611	80.0	112.0	159.0	250.0
32	288.00	4350	98.0	138.0	195.0	306.0
33	427.00	5010	126.0	177.0	251.0	394.0

- ¹ Continuously pulsed at stated watts and duty cycle
- ² Single pulse at stated watts (with coil at ambient room temperature 20°C)
- ³ Other coil awg sizes available — please consult factory
- ⁴ Reference number of turns

Specifications

Dielectric Strength	23-31 awg, 1200 VRMS ; 32-33 awg, 1500 VRMS
Recommended Minimum Heat Sink	Maximum watts dissipated by solenoid are based on an unrestricted flow of air at 20°C, with solenoid mounted on the equivalent of an aluminium plate measuring 314 mm square by 3.2 mm thick
Coil Resistance	23-33 awg, ±5%
Weight	609.5 g
Holding Force	218.0 N @ 105°C
Dimensions	See page G18

How to Order

Add the coil awg number (0XX) to the part number (for example: to order a 25% duty cycle unit rated at 63 VDC, specify 282352-027).

Please see www.ledex.com (click on Stock Products tab) for our list of stock products available through our distributors.

LINEAR Low Profile

Size 6ECM— Typical Force at 20°C

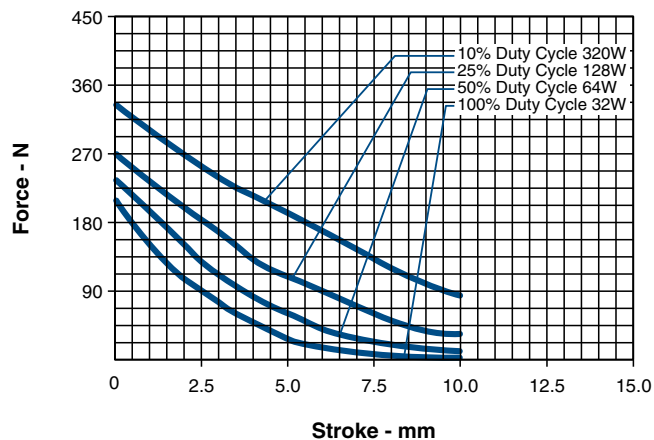

Size 6ECM— Typical Speed @ No Load, 20°C

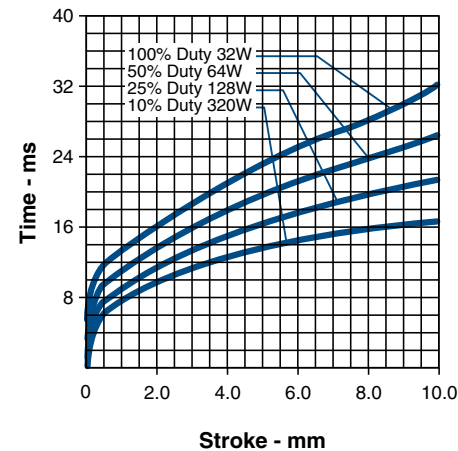

Force values for reference only.

All specifications subject to change without notice.

Ledex® Low Profile Size 7ECM — Push or Pull

Medium Stroke, Conical Face
Part Number: 282354-0XX

All catalogue products manufactured after
April 1, 2006 are RoHS Compliant

Performance

Maximum Duty Cycle	100%	50%	25%	10%
Maximum ON Time (sec) when pulsed continuously ¹	∞	80	38	16
Maximum ON Time (sec) for single pulse ²	∞	138	50	18
Watts (@ 20°C)	35	70	140	350
Ampere Turns (@ 20°C)	1805	2555	3610	5710

Coil Data

awg (0XX) ³	Resistance (@20°C)	# Turns ⁴	VDC (Nom)	VDC (Nom)	VDC (Nom)	VDC (Nom)
23	10.80	1044	19.0	27.0	39.0	61.0
24	16.50	1274	24.0	34.0	48.0	76.0
25	27.00	1635	31.0	43.0	61.0	97.0
26	43.80	2091	39.0	55.0	78.0	124.0
27	68.40	2603	49.0	69.0	98.0	155.0
28	108.00	3255	61.0	87.0	123.0	194.0
29	162.00	3933	75.0	106.0	151.0	238.0
30	265.00	5044	96.0	136.0	193.0	305.0
31	385.00	5800	116.0	164.0	232.0	367.0
32	583.00	7230	143.0	202.0	286.0	452.0
33	882.00	8400	176.0	248.0	351.0	600.0

- ¹ Continuously pulsed at stated watts and duty cycle
- ² Single pulse at stated watts (with coil at ambient room temperature 20°C)
- ³ Other coil awg sizes available — please consult factory
- ⁴ Reference number of turns

Specifications

Dielectric Strength	23-29 awg, 1200 VRMS ; 30-33 awg, 1500 VRMS
Recommended Minimum Heat Sink	Maximum watts dissipated by solenoid are based on an unrestricted flow of air at 20°C, with solenoid mounted on the equivalent of an aluminium plate measuring 384 m square by 3.2 mm thick
Coil Resistance	23-30 awg, ±5%; 31-33 awg, ±10%
Weight	1.134 kg
Holding Force	222.4 N @ 105°C
Dimensions	See page G18

How to Order

Add the coil awg number (0XX) to the part number (for example: to order a 25% duty cycle unit rated at 48 VDC, specify 282354-024).

Please see www.ledex.com (click on Stock Products tab) for our list of stock products available through our distributors.



LINEAR Low Profile

Size 7ECM— Typical Force @ 20°C

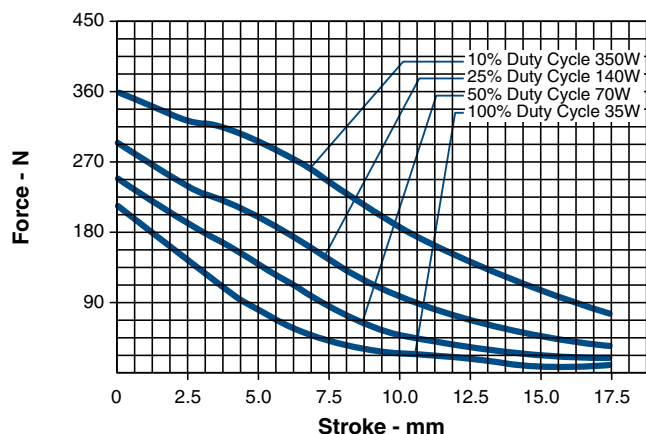

Force values for reference only.

Size 7ECM— Typical Speed @ No Load, 20°C

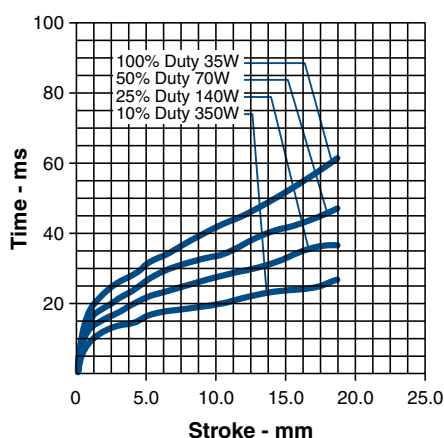

All specifications subject to change without notice.

Ledex® Low Profile Size 8ECM — Push or Pull

Medium Stroke, Conical Face
Part Number: 282356-0XX

All catalogue products manufactured after April 1, 2006 are RoHS Compliant

Performance

Maximum Duty Cycle	100%	50%	25%	10%		
Maximum ON Time (sec) when pulsed continuously ¹	∞	72	43	20		
Maximum ON Time (sec) for single pulse ²	∞	132	56	22		
Watts (@ 20°C)	41	82	164	410		
Ampere Turns (@ 20°C)	2195	3105	4155	6945		
Coil Data						
awg (0XX) ³	Resistance (@20°C)	# Turns ⁴	VDC (Nom)	VDC (Nom)	VDC (Nom)	VDC (Nom)
23	19.00	1512	28.0	40.0	56.0	88.0
24	31.20	1952	36.0	51.0	72.0	113.0
25	49.40	2448	45.0	64.0	90.0	142.0
26	78.00	3060	57.0	80.0	113.0	179.0
27	119.00	3740	70.0	99.0	140.0	221.0
28	184.00	4584	87.0	123.0	174.0	275.0
29	301.00	5936	111.0	157.0	222.0	351.0
30	425.00	6750	132.0	187.0	264.0	417.0
31	683.00	8750	167.0	237.0	335.0	529.0
32	1110.00	11000	213.0	302.0	427.0	—
33	1509.00	12050	249.0	352.0	498.0	—

- Continuously pulsed at stated watts and duty cycle
- Single pulse at stated watts (with coil at ambient room temperature 20°C)
- Other coil awg sizes available — please consult factory
- Reference number of turns

Specifications

Dielectric Strength	23-27 awg, 1200 VRMS ; 28-33 awg, 1500 VRMS
Recommended Minimum Heat Sink	Maximum watts dissipated by solenoid are based on an unrestricted flow of air at 20°C, with solenoid mounted on the equivalent of an aluminium plate measuring 514 mm square by 3.2 mm thick
Coil Resistance	23-30 awg, ±5%; 31-33 awg, ±10%
Weight	2.2 kg
Holding Force	533.7 N @ 105°C
Dimensions	See page G18

How to Order

Add the coil awg number (0XX) to the part number (for example: to order a 25% duty cycle unit rated at 90 VDC, specify 282356-025).

Please see www.ledex.com (click on Stock Products tab) for our list of stock products available through our distributors.

LINEAR Low Profile

Size 8ECM— Typical Force at 20°C

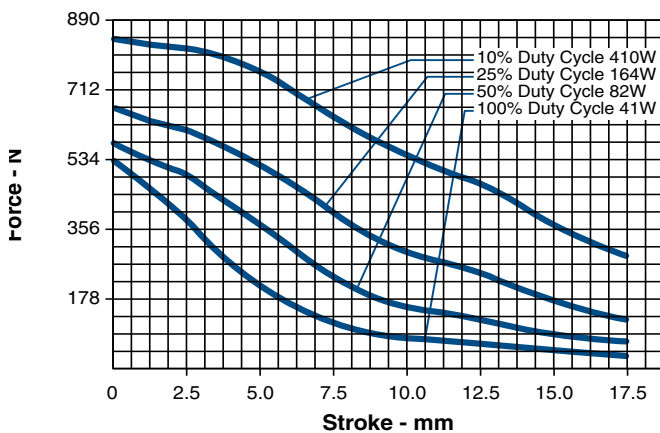

Size 8ECM— Typical Speed @ No Load, 20°C

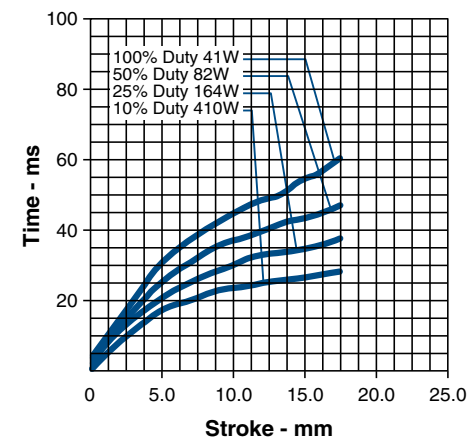

Force values for reference only.

All specifications subject to change without notice.

Ledex® Low Profile Dimensions

mm

All solenoids are illustrated in energised state

Size OECM

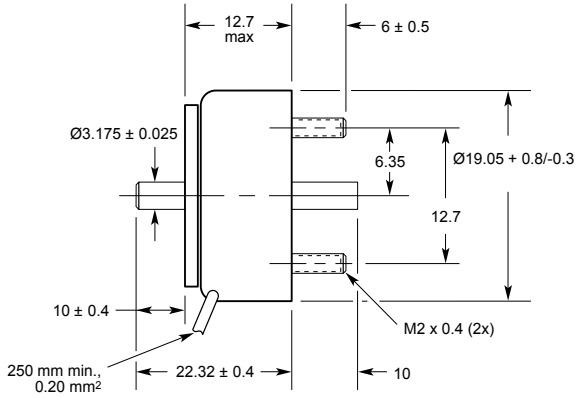

Size 1ECM

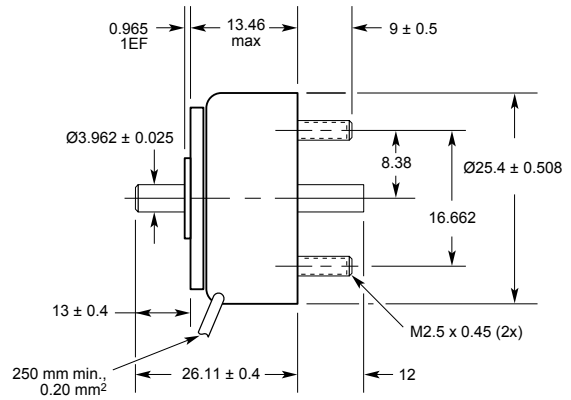

Size 2EFM/2ECM

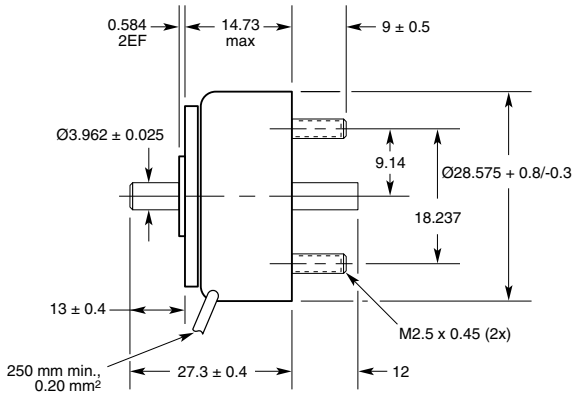

Size 3EFM/3ECM

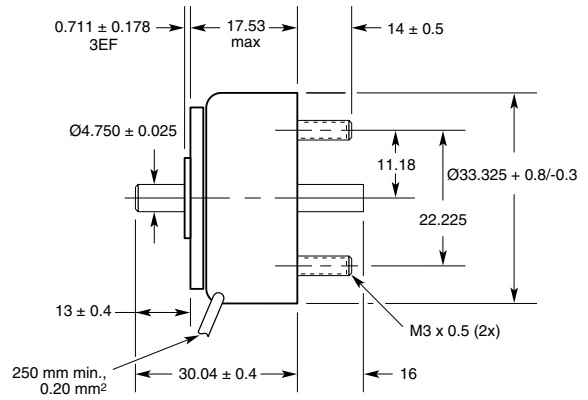

LINEAR Low Profile

All specifications subject to change without notice.

Ledex® Low Profile Dimensions

mm

All solenoids are illustrated in energised state

Size 4EFM/4ECM

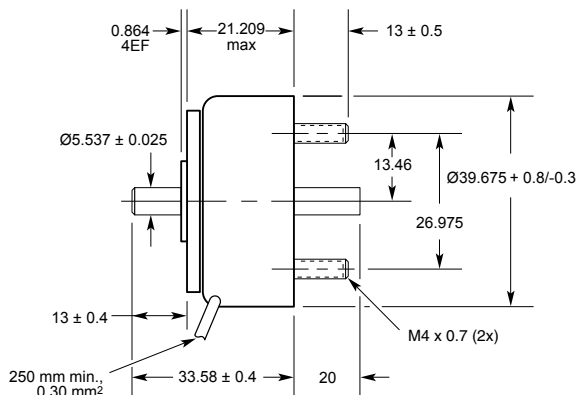

Size 5SFM

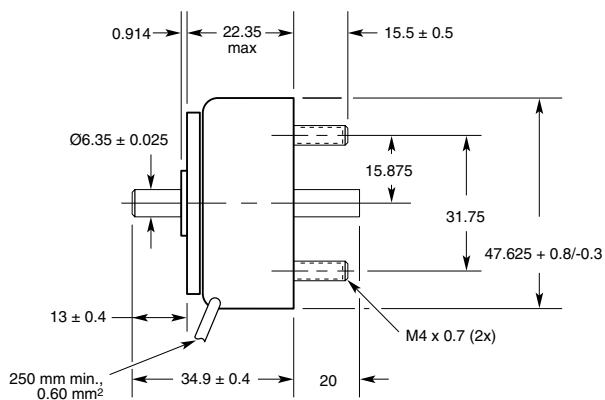

Size 5ECM

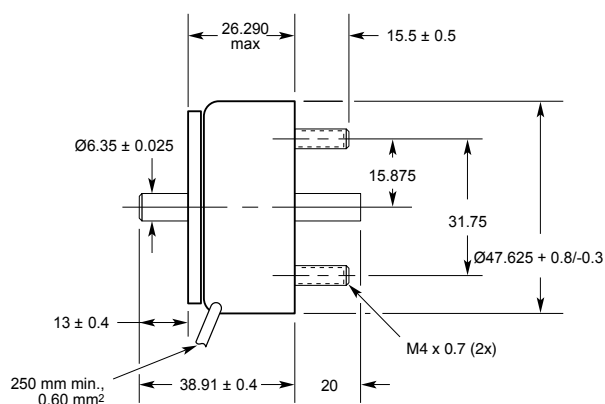

LINEAR Low Profile

ERMEC, S.L. BARCELONA
C/ Francesc Teixidó, 22
08918 Badalona
(Espanya)



Tel.: (+34) 902 450 160
Fax: (+34) 902 433 088
info@ermec.com
www.ermec.com

ERMEC, S.L. MADRID
Centro T.Unicem
28850 Torrejón de Ardoz
(Espanya)

PORTUGAL
portugal@ermec.com

BILBAO
bilbao@ermec.com

All specifications subject to change without notice.

Ledex® Low Profile Dimensions

mm

All solenoids are illustrated in energised state

Size 6SFM

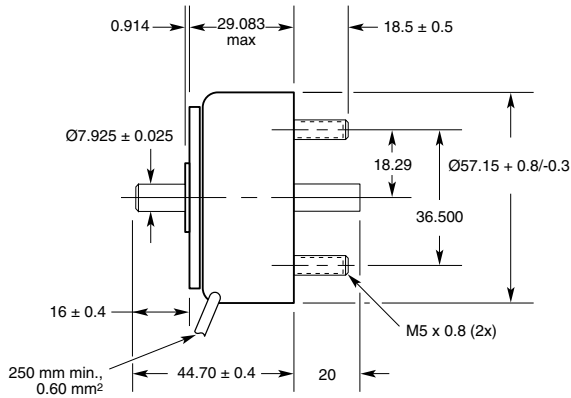

Size 6ECM

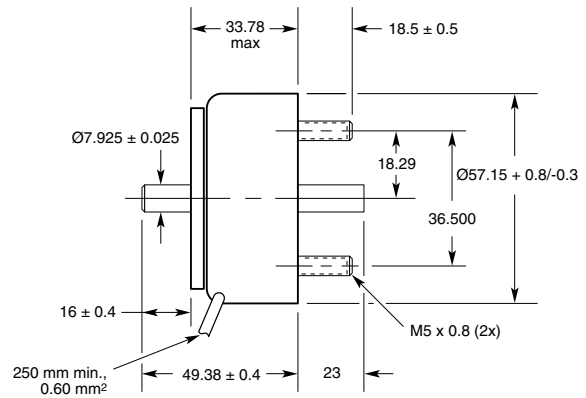

LINEAR Low Profile

Size 7ECM

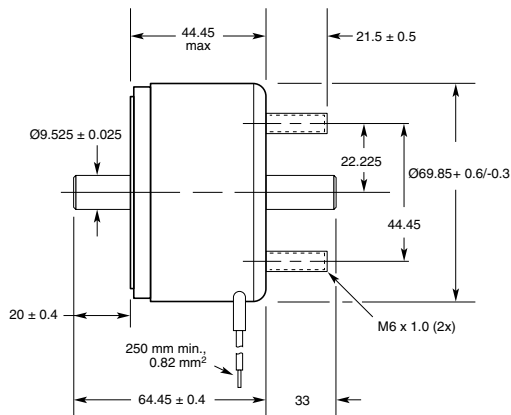

Size 8ECM

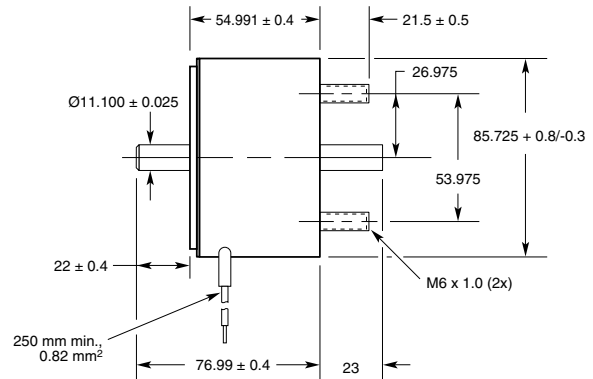

ERMEC, S.L. BARCELONA
C/ Francesc Teixidó, 22
08918 Badalona
(Espana)



Tel.: (+34) 902 450 160
Fax: (+34) 902 433 088
info@ermec.com
www.ermec.com

ERMEC, S.L. MADRID
Centro T..Unicem
28850 Torrejón de Ardoz
(Espana)

PORTUGAL
portugal@ermec.com

BILBAO
bilbao@ermec.com

All specifications subject to change without notice.