

8000 series

Momentary or alternate action
pushbutton switches



DISTINCTIVE FEATURES

Momentary or alternate

Bushing Ø 6.35 (1/4) and Ø 11.9 (15/32)

UL approved



ELECTRICAL SPECIFICATIONS

- Max. current/voltage rating with resistive load :
 - silver contacts : 4 A 30 VDC
 - gold plated contacts : 0.4 VA max. 20 VAC or DC
- Initial contact resistance : 10 mΩ max.
- Insulation resistance : 1,000 MΩ min. at 500 VDC
- Dielectric strength :
 - 1,000 Vrms 50 Hz min. between terminals
 - 2,000 Vrms 50 Hz min. between terminals and frame
- Electrical life : 30,000 cycles at full load



GENERAL SPECIFICATIONS

- Torque : 1.25 Nm (.922 Ft.lb) max. applied to nut
- Total travel : 2.70 mm (.106)
- Operating temperature : -40 °C to +85 °C (-40 °F to +185 °F)



MATERIALS

- Case : diallylphthalate (DAP)
- Actuator : brass, nickel plated
- Bushing : brass, nickel plated
- Housing : stainless steel
- Contacts
 - A : silver
 - AD : silver, gold plated
 - CD : brass, gold plated
- Terminal seal : epoxy

APEM products may be recycled at end-of-life for the re-claiming of valuable metal components.

The company reserves the right to change specifications without notice.



8000 series

Momentary or alternate action pushbutton switches

AGENCY APPROVAL



3 A 250 VAC,
6 A 125 VAC

Availability : consult factory for details of approved models.

Marking : to order switches marked UL, complete appropriate box of ordering format.



PANEL CUT-OUT

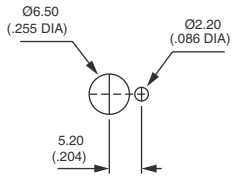

Standard

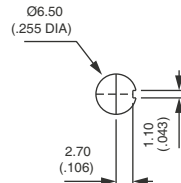

With K sealing option



ELECTRICAL FUNCTIONS

→ KEYWAY



Funct. 6 (ON-ON)

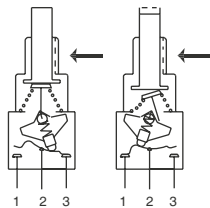

Funct. 2 (ON-MOM)



TERMINALS

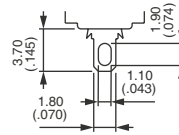

Solder lug

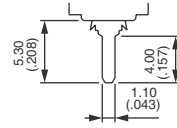

Straigh PC

8000 series

Momentary or alternate action pushbutton switches

BUILD YOUR PART NUMBER

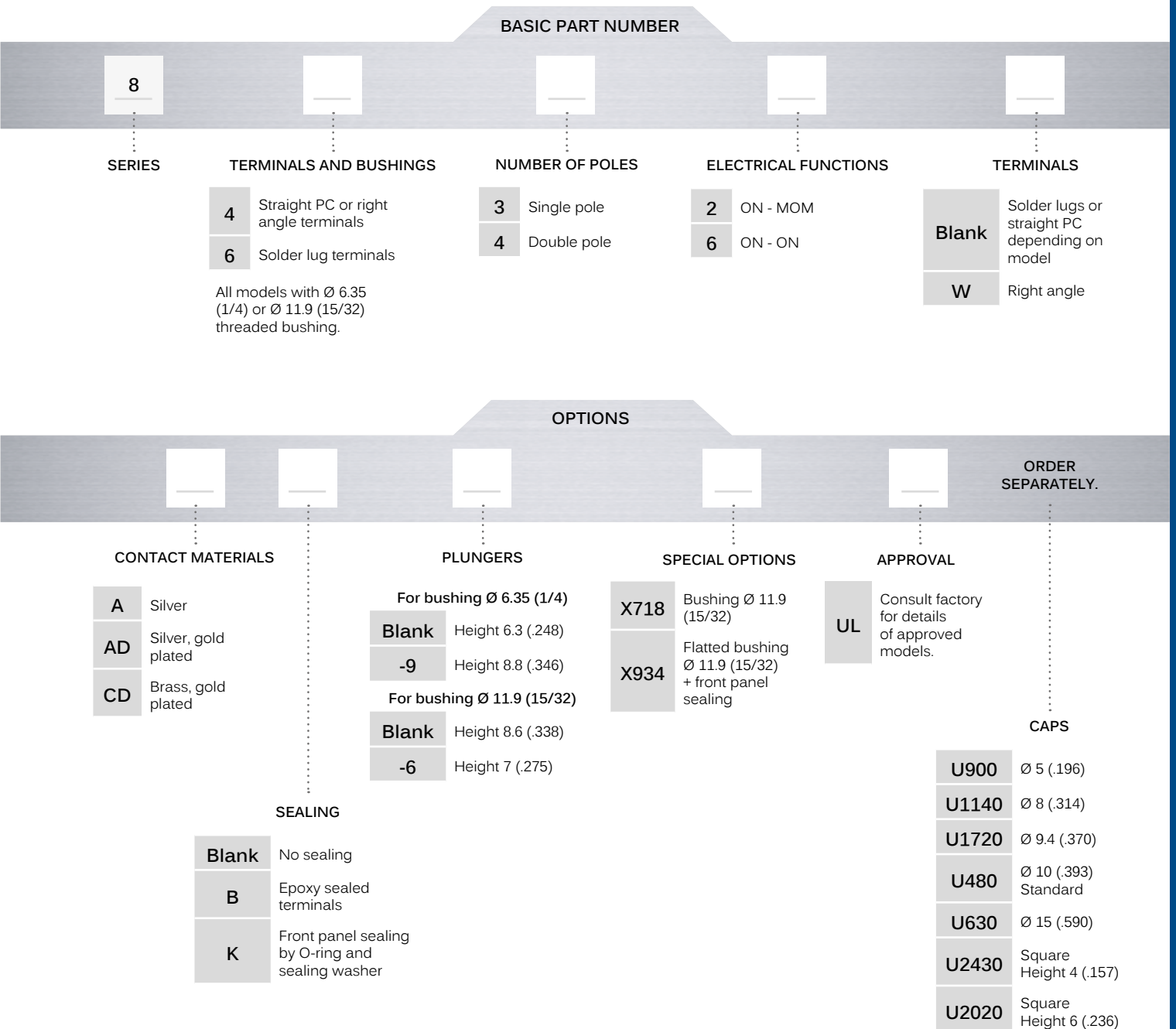

ABOUT THIS SERIES

On the following pages, you will find successively basic part numbers of switches and options in the same order as in above chart.

- ⚠ **Notice** : please note that not all combinations of above numbers are available. Refer to the following pages for further information.
- 🔒 **Sealing boots** are available to protect the switches against dust and water. See "Sealing Boots" section of website.
- 🔧 **Mounting accessories** : standard hardware supplied with all models : 2 hex nuts 8 mm (.314) across flats, 1 locking ring and 1 lockwasher. Standard and special hardware available is presented in the "Hardware" section of website.

8000 series

Momentary or alternate action pushbutton switches

SOLDER LUG TERMINALS : 8600



Single pole	8632	ON	MOM
	8636	ON	ON
Double pole		2-3	1-2
		5-6	4-5
	8642	ON	MOM
	8646	ON	ON



2-3



1-2

KEYWAY

Shown with standard plunger

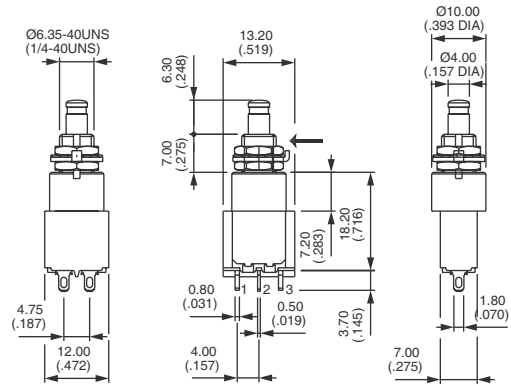

STRAIGHT PC TERMINALS : 8400



Single pole	8432	ON	MOM
	8436	ON	ON
Double pole		2-3	1-2
		5-6	4-5
	8442	ON	MOM
	8446	ON	ON



2-3



1-2

KEYWAY

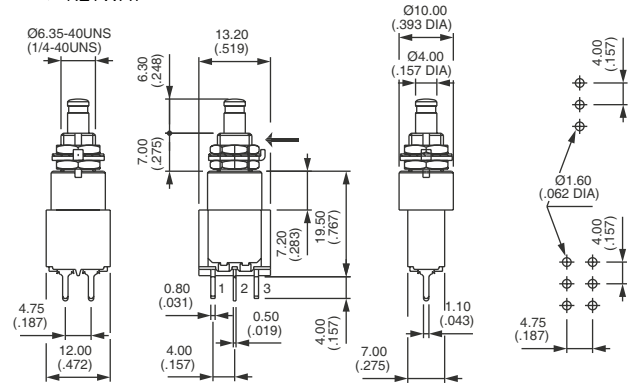

RIGHT ANGLE TERMINALS HORIZONTAL : 8400W



Single pole	8432W	ON	MOM
	8436W	ON	ON
Double pole		2-3	1-2
		5-6	4-5
	8442W	ON	MOM
	8446W	ON	ON



2-3



1-2

KEYWAY

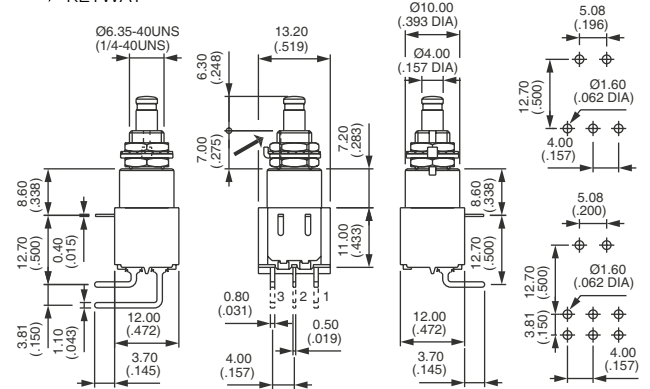

8000 series

Momentary or alternate action pushbutton switches

CONTACT MATERIALS

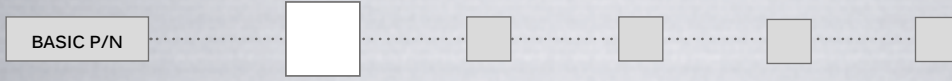

- A Silver
- AD Silver, gold plated
- CD Brass, gold plated

SEALING



- Blank No sealing
 - K Frontal sealing by O-ring and sealing washer. Protects the switch against water and dust. Panel seal withstands 1 bar pressure.
 - B Epoxy sealed terminals
 - KB Combined sealings
- Sealing boot : see "Sealing boots" section of website.

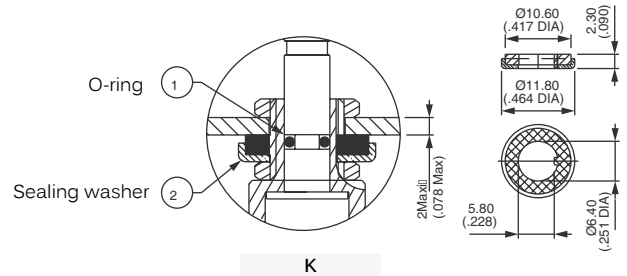

K

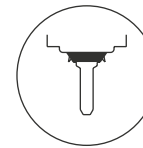

B

PLUNGERS



Dash compulsory before plunger code.

FOR Ø 6.35 (1/4) BUSHING

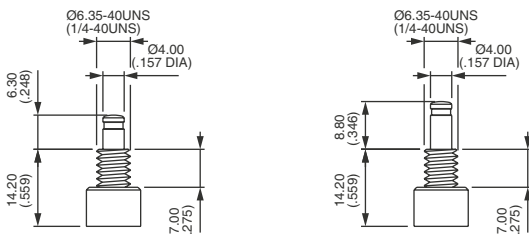

Blank Standard

-9

FOR Ø 11.9 (15/32) BUSHING (X718 MODELS)

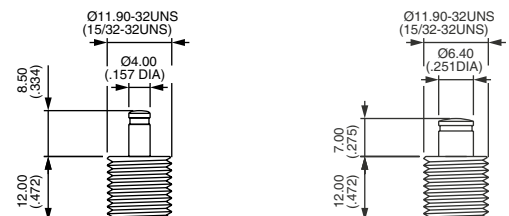

Blank Standard

-6

8000 series

Momentary or alternate action pushbutton switches

SPECIAL OPTIONS

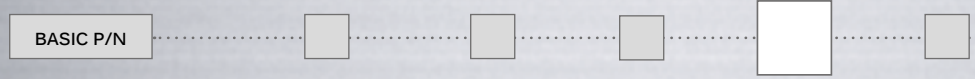

- X601** Silver plated brass contacts
Current/voltage rating for an electrical life of 20,000 cycles : 0.5 A 30 VDC.
Minimum quantity : 5,000 pieces per model and shipment.
- X718** Bushing Ø 11.9 (15/32)
For all basic models (solder lug, straight PC or right angle terminals)
Available with plungers shown on previous page (Standard and -6)
K sealing option available.
- X748** Snap-in mounting. Consult factory.
Panel cut-out 15 x 12.5 (.59 x .492)
- X934** Flatted bushing Ø 11.9 (15/32) + sealing by two O-rings (for plunger -6 only).
Epoxy sealed terminals.

OPTION X718

→ KEYWAY

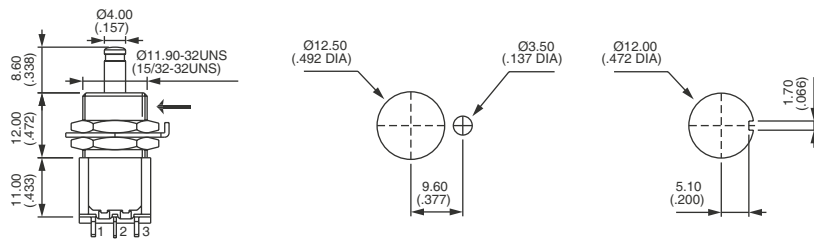

OPTION X934

→ KEYWAY

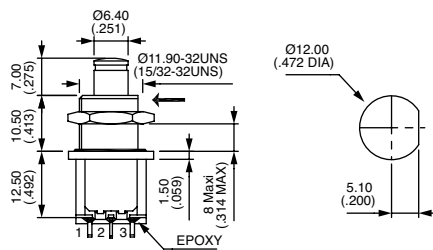

AGENCY APPROVAL

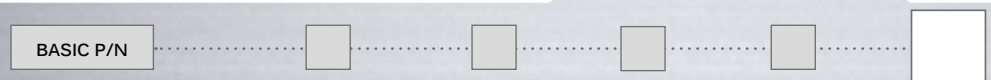

UL

Availability : consult factory for details of approved models.

Marking : to order switches marked UL, complete above box with "UL".

8000 series

Momentary or alternate action pushbutton switches

CAPS

Order separately

The caps below are for Ø 4 mm plungers (standard and -9), except U2600.

Cap colors

Replace last "0" by number :

- 1 Blue
- 1/4 Dark blue
- 2 Black
- 3 Green
- 4 Grey
- 5 Yellow
- 6 Red
- 7 Ivory
- 7/1 White
- 9 Orange

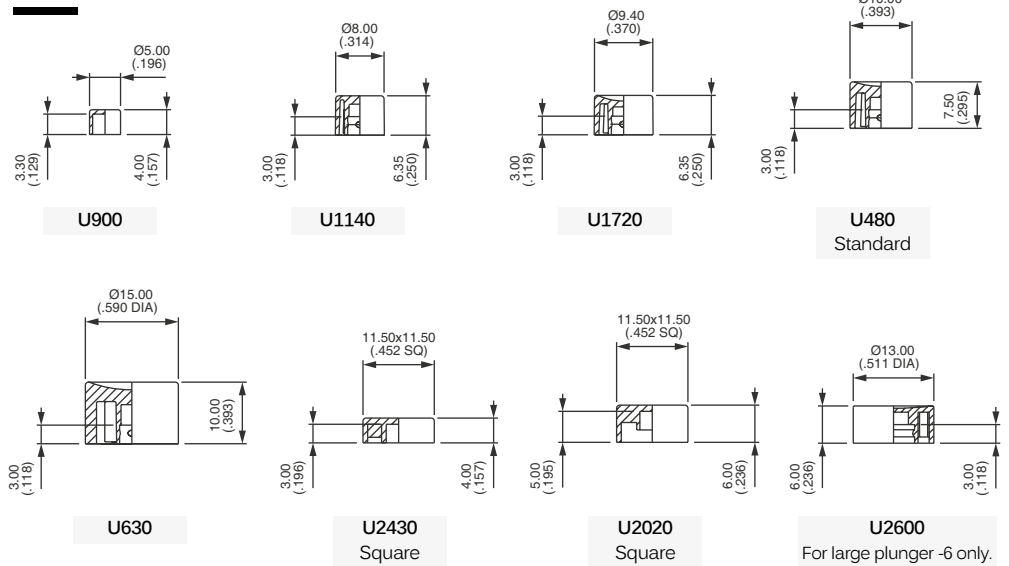

DRESS NUTS

Order separately

Chrome plated.

