

IHL series

Hall effect pushbutton switches •
bushing Ø 12 mm • linear



DISTINCTIVE FEATURES

- Linear output pushbutton
- 0.5 to 4.5 volt output
- Different operating forces
- 5 million cycles
- Sealed to IP67



ENVIRONMENTAL SPECIFICATIONS

- Front panel sealing : IP67 according to IEC 60529
- Operating temperature : -40 °C to +85 °C (-40 °F to +185 °F)
- EMC testing : 10 V per meter extend to radiated fields in frequency range of 80 Mhz to 1,000 MHz. 1KHz 80 % sine wave modulation according to IEC/EN 61000-4-3



ELECTRICAL SPECIFICATIONS

- Supply voltage :
4.5 VDC to 5.5 VDC without regulator
6.5 VDC to 24 VDC with 5V regulator
- Supply current : 9 mA max.
- Max. output current : 1.25 mA
- Max. output voltage with or without regulator : see graph next page.



GENERAL SPECIFICATIONS

- Panel thickness : 1.5 mm (.059) min. - 10 mm (.393) max.
- Total travel : 4 mm (.160) ± 0.3 mm
- Mechanical life : 5 million cycles
- Torque : 1 Nm max. applied to nut



MATERIALS

- Case : PA46, UL94-V0
- Actuator : polyamide 6/6
- Bushing : polyamide 6/6
- Multi-wire leads : AWG26, 150 mm

The company reserves the right to change specifications without notice.



IHL series

Hall effect pushbutton switches •
bushing Ø 12 mm • linear



ELECTRICAL FUNCTIONS

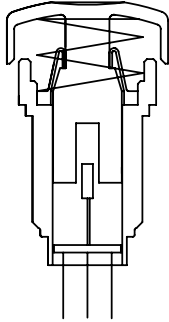

WIRING DIAGRAM

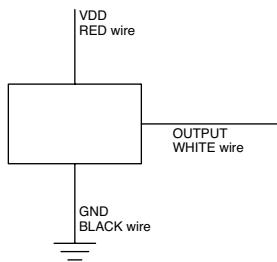

MOUNTING

PANEL CUT-OUT

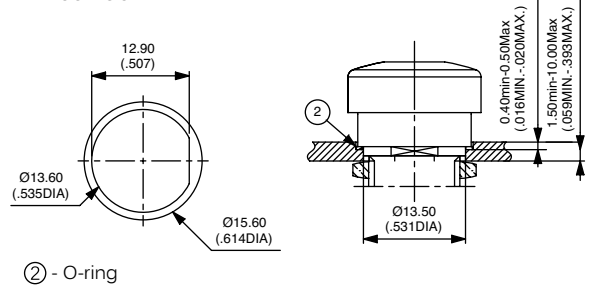

MATRIX MOUNTING

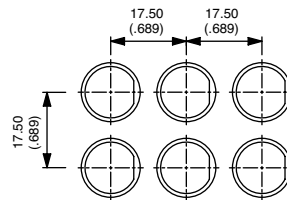

BACK OF PANEL SPACE REQUIREMENT

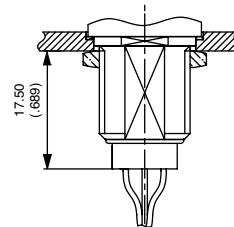

LINEAR OUTPUT GRAPH (VDC = 5V@20°C)

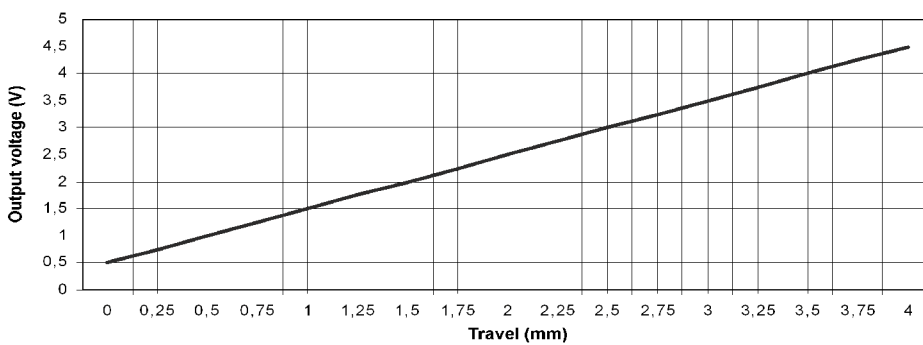

IHL series

Hall effect pushbutton switches •
bushing Ø 12 mm • linear



BUILD YOUR PART NUMBER

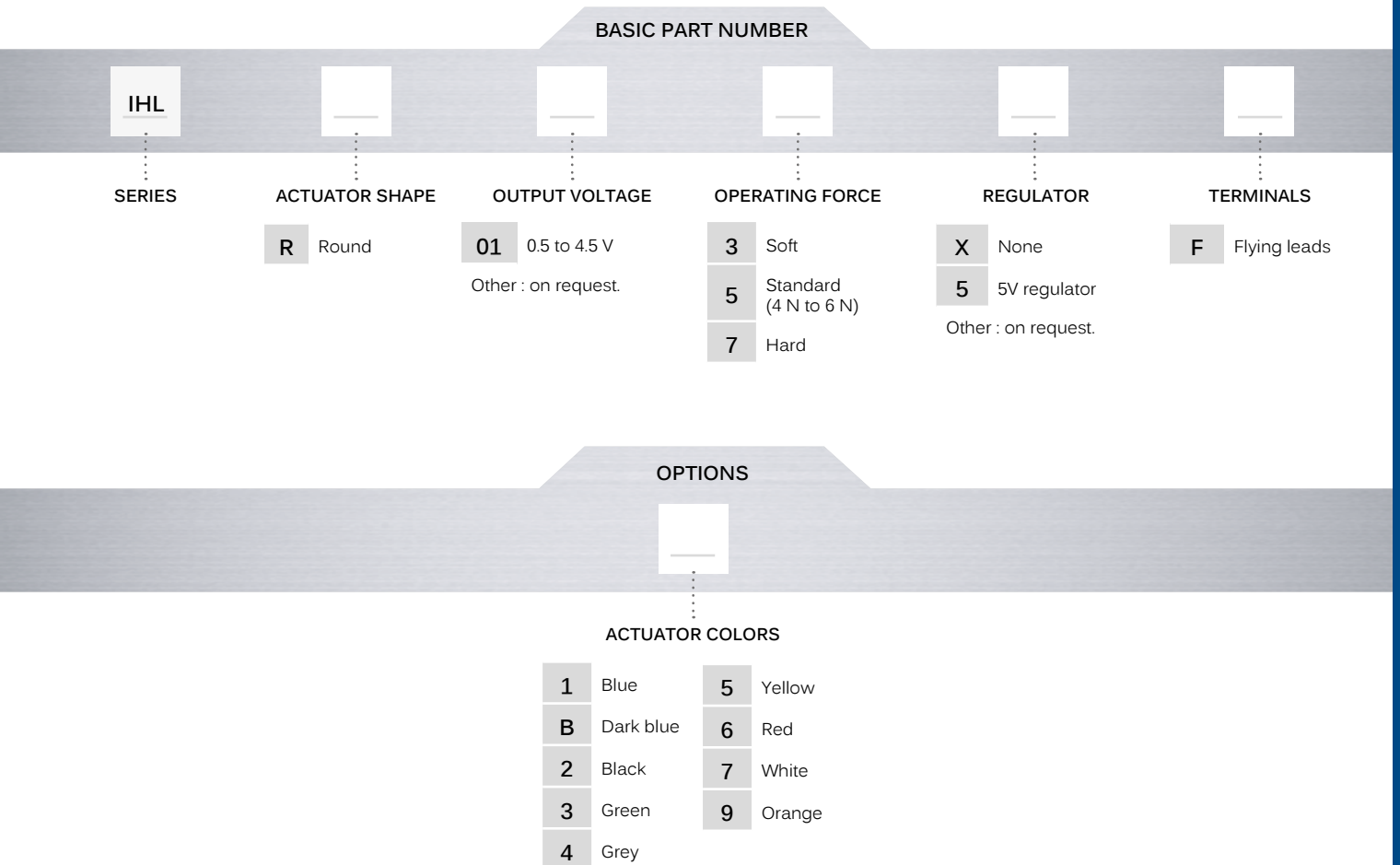

ABOUT THIS SERIES

On the following pages, you will find successively basic part numbers of switches and options in the same order as in above chart.

- Notice** : please note that not all combinations of above numbers are available. Refer to the following pages for further information.
- Mounting accessories** : Standard hardware supplied : 1 hex nut 14 mm (.551) across flats and 1 O-Ring. Hex nut part number U166.

IHL series

Hall effect pushbutton switches •
bushing Ø 12 mm • linear

WITHOUT REGULATOR



- Soft operating force
IHLR013XF
- Standard operating force
IHLR015XF
- Hard operating force
IHLR017XF

WITH 5V REGULATOR



- Soft operating force
IHLR0135F
- Standard operating force
IHLR0155F
- Hard operating force
IHLR0175F

→ FLAT

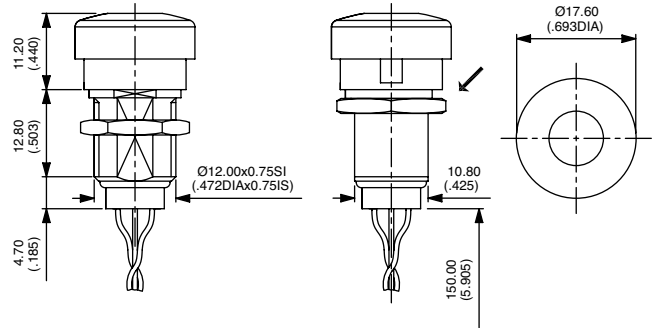

→ FLAT

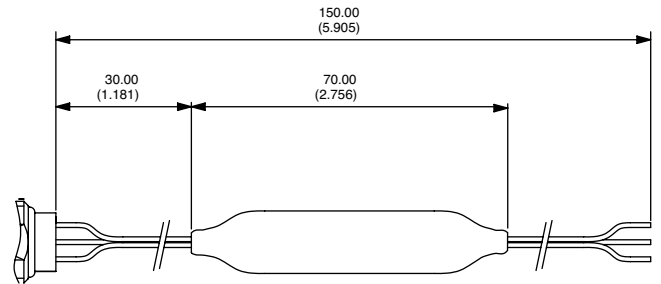

ACTUATOR COLORS

BASIC P/N



- 1 Blue
- B Dark blue
- 2 Black
- 3 Green
- 4 Grey
- 5 Yellow
- 6 Red
- 7 White
- 9 Orange