

ø16 Switches and Pilot Lights

A6 Series



Suitable for a wide variety of office and factory applications.

Features IDEC's original mechanism for snap-action switching.

The LED lamp contains a current-limiting resistor and a diode for protection against reverse connection.

Degree of protection: IP40 and IP65 (IEC 60529)



• See website for details on approvals and standards.

Standard Bezel

A6 SERIES

[Bezel size] [From panel front] [Shape] [Contact rating] [Action] [Operating stroke]

ø18 □18 18×24 9 mm Unibody 3A Light 3 mm

Illuminated Pushbuttons	Pushbuttons	Pilot Lights	Selector Switches	Key Selector Switches

Flush Bezel

A6 SERIES

[Bezel size] [From panel front] [Shape] [Contact rating] [Action] [Operating stroke]

ø24 □24 18×24 2 mm Unibody 3A Light 3 mm

Flush bezel accessories provide a sleek updated look. Enables downsizing of equipment.

Illuminated Pushbuttons	Pushbuttons	Pilot Lights	Selector Switches Unibody	Key Selector Switches

ø16 A6 Series Miniature Switches and Pilot Lights

Light duty in short 22mm body length.



- APEM
- Switches & Pilot Lights
- Control Boxes
- Emergency Stop Switches
- Enabling Switches
- Safety Products
- Explosion Proof
- Terminal Blocks
- Relays & Sockets
- Circuit Protectors
- Power Supplies
- LED Illumination
- Controllers
- Operator Interfaces
- Sensors
- AUTO-ID
- Flush Silhouette
- ø16
- ø22
- ø30
- Miniature
- Pilot Lights
- LB
- A6

Specifications and Ratings

Contact Ratings (Contact Block)

Rated Insulation Voltage		250V			
Rated Thermal Current		3A			
Operating Voltage (AC/DC)		12V	24V	110V	220V
AC 50/60 Hz	Resistive Load	—	—	1.0A	0.5A
	Inductive Load	—	—	0.7A	0.5A
DC	Resistive Load	1.0A	1.0A	0.2A	—
	Inductive Load	0.7A	0.7A	0.5A	—
Contact Material		Silver with gold contact			

- Minimum applicable load: 5V AC/DC, 1 mA (applicable range may vary with operating conditions and load types)

Weight (example)

Weight (approx.)	AL6M-M24:	8g
	AL6M-M221:	46g
	AL6M-P4:	6g
	AL6M-P21:	45g
	AB6M-M2:	7g
	AS6M-2Y2:	9g
	AS6M-2KT2A:	21g

Specifications

Operating Temperature		-25 to +55°C (no freezing)
Storage Temperature		-30 to +80°C (no freezing)
Operating Humidity		45 to 85% RH (no condensation)
Contact Resistance		50 mΩ maximum (initial value)
Insulation Resistance		100 MΩ minimum (500V DC megger)
Dielectric Strength	Switch Unit	Between live and dead metal parts: 2,000V AC, 1 minute Between terminals of different poles: 2,000V AC, 1 minute Between terminals of the same pole: 1,000V AC, 1 minute Between contact and lamp terminals: 1,500V AC, 1 minute
	Illumination Unit	Between live part and ground: 2,000V AC, 1 minute
Vibration Resistance		Operating extremes: 5 to 55 Hz, amplitude 0.75 mm
Shock Resistance		Damage limits: 500 m/s ² (50G) Operating extremes: 200 m/s ² (20G)
Mechanical Durability (minimum operations)		Momentary: 1,000,000 operations Maintained: 100,000 operations Pushlock Turn Reset: 100,000 operations Selector Switch: 250,000 operations Key Selector Switch: 250,000 operations
Electrical Durability (minimum operations)		Other than Maintained: 100,000 operations Maintained: 50,000 operations (Switching frequency 1200 operations/h)
Degree of Protection		IP40, IP65 (IEC 60529)
Terminal Style		Solder terminal

LED Lamp Ratings (LATD)

Part No.	LATD-5②	LATD-1②	LATD-2②
Lamp Base	Exclusive for A series control units		
Voltage Range	5V DC ±5%	12V AC/DC ±10%	24V AC/DC ±10%
Rated Voltage	5V DC	12V AC/DC	24V AC/DC
Current Draw	AC	—	9 mA
	DC	8 mA	8 mA
Color Code ②	A (amber), G (green), JW (pure white), R (red), S (blue)		
Lamp Base Color	Same as illumination color (except JW - gray base)		
Voltage Marking	Die stamped on the base		
Life (reference value)	Approx. 50,000 hours (The luminance is reduced to 50% of the initial intensity when used on complete DC.)		
Internal Circuit			

- Specify a color code in place of ② in the Part No.
A (amber), G (green), JW (pure white), R (red), S (blue)
- Use a pure white (JW) LED lamp for yellow illumination.

Illuminated Pushbuttons

Package Quantity: 1

Shape	Operation	Operating Voltage	Contact	Part No.		② Illumination Color Code
				IP40	IP65	
Round AL6M 	Momentary	5V DC	SPDT	AL6M-M11②	AL6M-M11P②	
			DPDT	AL6M-M21②	AL6M-M21P②	
		12V AC/DC	SPDT	AL6M-M13②	AL6M-M13P②	
			DPDT	AL6M-M23②	AL6M-M23P②	
		24V AC/DC	SPDT	AL6M-M14②	AL6M-M14P②	
			DPDT	AL6M-M24②	AL6M-M24P②	
	Maintained	5V DC	SPDT	AL6M-A11②	AL6M-A11P②	
			DPDT	AL6M-A21②	AL6M-A21P②	
		12V AC/DC	SPDT	AL6M-A13②	AL6M-A13P②	
			DPDT	AL6M-A23②	AL6M-A23P②	
		24V AC/DC	SPDT	AL6M-A14②	AL6M-A14P②	
			DPDT	AL6M-A24②	AL6M-A24P②	
Square AL6Q 	Momentary	5V DC	SPDT	AL6Q-M11②	AL6Q-M11P②	
			DPDT	AL6Q-M21②	AL6Q-M21P②	
		12V AC/DC	SPDT	AL6Q-M13②	AL6Q-M13P②	
			DPDT	AL6Q-M23②	AL6Q-M23P②	
		24V AC/DC	SPDT	AL6Q-M14②	AL6Q-M14P②	
			DPDT	AL6Q-M24②	AL6Q-M24P②	
	Maintained	5V DC	SPDT	AL6Q-A11②	AL6Q-A11P②	
			DPDT	AL6Q-A21②	AL6Q-A21P②	
		12V AC/DC	SPDT	AL6Q-A13②	AL6Q-A13P②	
			DPDT	AL6Q-A23②	AL6Q-A23P②	
		24V AC/DC	SPDT	AL6Q-A14②	AL6Q-A14P②	
			DPDT	AL6Q-A24②	AL6Q-A24P②	
Rectangular AL6H 	Momentary	5V DC	SPDT	AL6H-M11②	AL6H-M11P②	
			DPDT	AL6H-M21②	AL6H-M21P②	
		12V AC/DC	SPDT	AL6H-M13②	AL6H-M13P②	
			DPDT	AL6H-M23②	AL6H-M23P②	
		24V AC/DC	SPDT	AL6H-M14②	AL6H-M14P②	
			DPDT	AL6H-M24②	AL6H-M24P②	
	Maintained	5V DC	SPDT	AL6H-A11②	AL6H-A11P②	
			DPDT	AL6H-A21②	AL6H-A21P②	
		12V AC/DC	SPDT	AL6H-A13②	AL6H-A13P②	
			DPDT	AL6H-A23②	AL6H-A23P②	
		24V AC/DC	SPDT	AL6H-A14②	AL6H-A14P②	
			DPDT	AL6H-A24②	AL6H-A24P②	
Rectangular w/three-sided barrier AL6G 	Momentary	5V DC	SPDT	AL6G-M11②	AL6G-M11P②	
			DPDT	AL6G-M21②	AL6G-M21P②	
		12V AC/DC	SPDT	AL6G-M13②	AL6G-M13P②	
			DPDT	AL6G-M23②	AL6G-M23P②	
		24V AC/DC	SPDT	AL6G-M14②	AL6G-M14P②	
			DPDT	AL6G-M24②	AL6G-M24P②	
	Maintained	5V DC	SPDT	AL6G-A11②	AL6G-A11P②	
			DPDT	AL6G-A21②	AL6G-A21P②	
		12V AC/DC	SPDT	AL6G-A13②	AL6G-A13P②	
			DPDT	AL6G-A23②	AL6G-A23P②	
		24V AC/DC	SPDT	AL6G-A14②	AL6G-A14P②	
			DPDT	AL6G-A24②	AL6G-A24P②	

Specify a color code in place of ② in the Part No.

A: amber
G: green
JW: pure white
R: red
S: blue
Y: yellow

- See B-151 for dimensions.
- See B-166 for marking plate size and engraving area.
- A pure white (JW) LED lamp is used for yellow illumination.

Pilot Lights

Package Quantity: 1

Shape	Operating Voltage	Part No.		② Illumination Color Code
		IP40	IP65	
Round AL6M-P 	5V DC	AL6M-P1②	AL6M-P1P②	Specify a color code in place of ② in the Part No. A: amber G: green JW: pure white R: red S: blue Y: yellow
	12V AC/DC	AL6M-P3②	AL6M-P3P②	
	24V AC/DC	AL6M-P4②	AL6M-P4P②	
Square AL6Q-P 	5V DC	AL6Q-P1②	AL6Q-P1P②	
	12V AC/DC	AL6Q-P3②	AL6Q-P3P②	
	24V AC/DC	AL6Q-P4②	AL6Q-P4P②	
Rectangular AL6H-P 	5V DC	AL6H-P1②	AL6H-P1P②	
	12V AC/DC	AL6H-P3②	AL6H-P3P②	
	24V AC/DC	AL6H-P4②	AL6H-P4P②	
Rectangular w/three-sided barrier AL6G-P 	5V DC	AL6G-P1②	AL6G-P1P②	
	12V AC/DC	AL6G-P3②	AL6G-P3P②	
	24V AC/DC	AL6G-P4②	AL6G-P4P②	

- See **B-151** for dimensions.
- See **B-166** for marking plate size and engraving area.
- A pure white (JW) LED lamp is used for yellow illumination.

APEM

Switches & Pilot Lights

Control Boxes

Emergency Stop Switches

Enabling Switches

Safety Products

Explosion Proof

Terminal Blocks

Relays & Sockets

Circuit Protectors

Power Supplies

LED Illumination

Controllers

Operator Interfaces

Sensors

AUTO-ID

Flush Silhouette

ø16

ø22

ø30

Miniature

Pilot Lights

LB

A6



ERMEC, S.L. BARCELONA
C/ Francesc Teixidó, 22
08918 Badalona SPAIN

Tel. +34 902 450 160
info@ermec.com
www.ermec.com

ERMEC, S.L. - MADRID
C/ Puerto Rico, 4
28222 Majadahonda (Madrid) SPAIN

bilbao@ermec.com
portugal@ermec.com

Dimensions (Illuminated Pushbuttons & Pilot Lights)

All dimensions in mm.

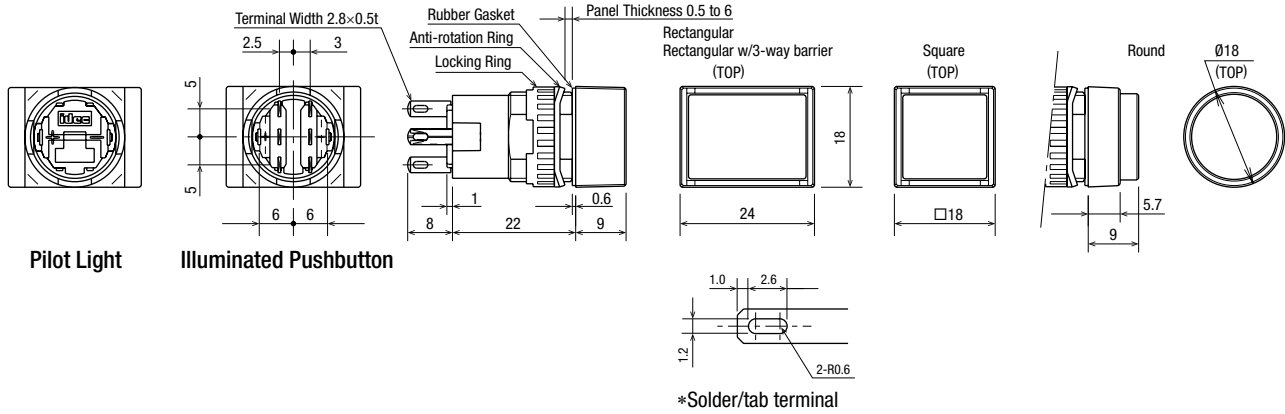

Terminal Arrangement (bottom view)

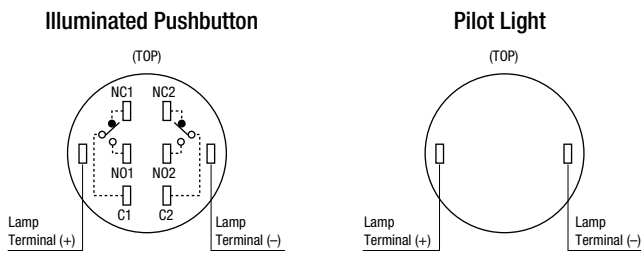

With contact: NC1, NO1, C1 terminal only

Mounting Hole Layout

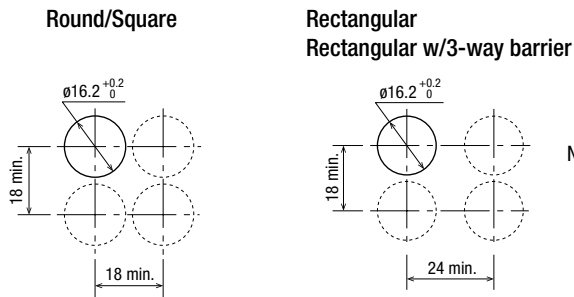

Note: Determine mounting centers to ensure easy operation.

- APEM
- Switches & Pilot Lights
- Control Boxes
- Emergency Stop Switches
- Enabling Switches
- Safety Products
- Explosion Proof
- Terminal Blocks
- Relays & Sockets
- Circuit Protectors
- Power Supplies
- LED Illumination
- Controllers
- Operator Interfaces
- Sensors
- AUTO-ID
- Flush Silhouette
- ø16
- ø22
- ø30
- Miniature
- Pilot Lights
- LB
- A6



ERMEC, S.L. BARCELONA
C/ Francesc Teixido, 22
08918 Badalona SPAIN





Tel. +34 902 450 160
info@ermec.com
www.ermec.com

ERMEC, S.L. - MADRID
C/ Puerto Rico, 4
28222 Majadahonda (Madrid) SPAIN

bilbao@ermec.com
portugal@ermec.com

Pushbuttons

Package Quantity: 1

Shape	Button Style	Operation	Contact	Part No.		Color Code ①②
				IP40	IP65	
Round AB6M 	Button	Momentary	SPDT	AB6M-M1①	AB6M-M1P①	B black G: green R: red S: blue W: white Y: yellow A: amber G: green R: red S: blue W: white Y: yellow
			DPDT	AB6M-M2①	AB6M-M2P①	
		Maintained	SPDT	AB6M-A1①	AB6M-A1P①	
			DPDT	AB6M-A2①	AB6M-A2P①	
	Lens	Momentary	SPDT	AB6M-M1L②	AB6M-M1PL②	
			DPDT	AB6M-M2L②	AB6M-M2PL②	
		Maintained	SPDT	AB6M-A1L②	AB6M-A1PL②	
			DPDT	AB6M-A2L②	AB6M-A2PL②	
Square AB6Q 	Button	Momentary	SPDT	AB6Q-M1①	AB6Q-M1P①	
			DPDT	AB6Q-M2①	AB6Q-M2P①	
		Maintained	SPDT	AB6Q-A1①	AB6Q-A1P①	
			DPDT	AB6Q-A2①	AB6Q-A2P①	
	Lens	Momentary	SPDT	AB6Q-M1L②	AB6Q-M1PL②	
			DPDT	AB6Q-M2L②	AB6Q-M2PL②	
		Maintained	SPDT	AB6Q-A1L②	AB6Q-A1PL②	
			DPDT	AB6Q-A2L②	AB6Q-A2PL②	
Rectangular AB6H 	Button	Momentary	SPDT	AB6H-M1①	AB6H-M1P①	
			DPDT	AB6H-M2①	AB6H-M2P①	
		Maintained	SPDT	AB6H-A1①	AB6H-A1P①	
			DPDT	AB6H-A2①	AB6H-A2P①	
	Lens	Momentary	SPDT	AB6H-M1L②	AB6H-M1PL②	
			DPDT	AB6H-M2L②	AB6H-M2PL②	
		Maintained	SPDT	AB6H-A1L②	AB6H-A1PL②	
			DPDT	AB6H-A2L②	AB6H-A2PL②	
Rectangular w/three-sided barrier AB6G 	Button	Momentary	SPDT	AB6G-M1①	AB6G-M1P①	
			DPDT	AB6G-M2①	AB6G-M2P①	
		Maintained	SPDT	AB6G-A1①	AB6G-A1P①	
			DPDT	AB6G-A2①	AB6G-A2P①	
	Lens	Momentary	SPDT	AB6G-M1L②	AB6G-M1PL②	
			DPDT	AB6G-M2L②	AB6G-M2PL②	
		Maintained	SPDT	AB6G-A1L②	AB6G-A1PL②	
			DPDT	AB6G-A2L②	AB6G-A2PL②	

- Specify a color code in place of ① or ② in the Part No.
- See **B-151** for dimensions.
- See **B-166** for marking plate size and engraving area.
- Black is available for lens style buttons. Black lens consists of a clear lens and a black marking plate. Specify "B" in place of ② in the Part No. Example: **AB6H-M2LB**

APEM

Switches & Pilot Lights

Control Boxes

Emergency Stop Switches

Enabling Switches

Safety Products

Explosion Proof

Terminal Blocks

Relays & Sockets

Circuit Protectors

Power Supplies

LED Illumination

Controllers

Operator Interfaces

Sensors

AUTO-ID

Flush Silhouette

ø16

ø22

ø30

Miniature

Pilot Lights

LB

A6



ERMEC, S.L. BARCELONA
C/ Francesc Teixido, 22
08918 Badalona SPAIN

Tel. +34 902 450 160
info@ermec.com
www.ermec.com

ERMEC, S.L. - MADRID
C/ Puerto Rico, 4
28222 Majadahonda (Madrid) SPAIN

bilbao@ermec.com
portugal@ermec.com

Dimensions (Pushbuttons)

All dimensions in mm.

Pushbutton

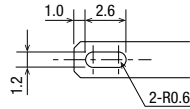
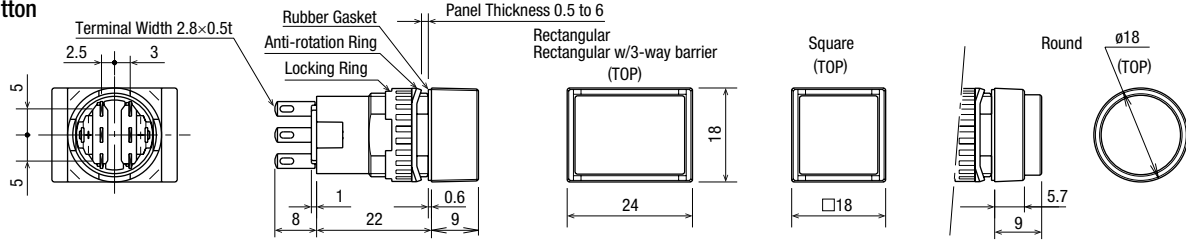

* Solder/Tab Terminal

• See B-164 for lens and button maintenance parts.

Mounting Hole Layout

Round/Square

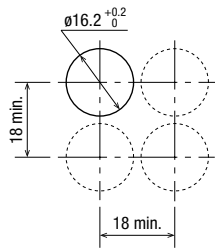

Rectangular w/3-way barrier

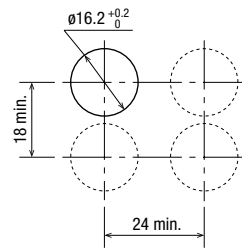

Note: Determine mounting centers to ensure easy operation.

Terminal Arrangement (bottom view)

Pushbutton

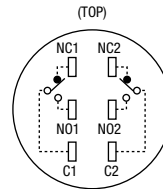

Note: SPDT has only NC1, NO1, and C1 terminals.

- APEM
- Switches & Pilot Lights
- Control Boxes
- Emergency Stop Switches
- Enabling Switches
- Safety Products
- Explosion Proof
- Terminal Blocks
- Relays & Sockets
- Circuit Protectors
- Power Supplies
- LED Illumination
- Controllers
- Operator Interfaces
- Sensors
- AUTO-ID
- Flush Silhouette
- ø16
- ø22
- ø30
- Miniature
- Pilot Lights

LB

A6



ERMEC, S.L. BARCELONA
C/ Francesc Teixidó, 22
08918 Badalona SPAIN

Tel. +34 902 450 160
info@ermec.com
www.ermec.com

ERMEC, S.L. - MADRID
C/ Puerto Rico, 4
28222 Majadahonda (Madrid) SPAIN

bilbao@ermec.com
portugal@ermec.com

Selector Switches

Operator position can be changed by IDEC's original bezel rotating and locking system. The bezel can be locked at every 45° and bezel rotation is prevented while mounting on a panel.

Example: 3-position

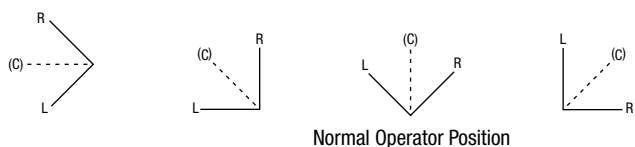

How to change the operator position

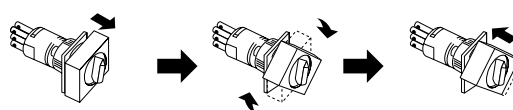

Pull out the bezel to release the lock. Rotate the bezel, and push it in at 45° intervals to lock the bezel.

Package Quantity: 1

Shape	Position	Contact	Part No.	
			IP40	IP65
 Round AS6M-□Y	90° 2-position	Maintained	SPDT AS6M-2Y1	AS6M-2Y1P
		Spring return from right to left	DPDT AS6M-2Y2	AS6M-2Y2P
	45° 3-position	Maintained	DPDT AS6M-3Y2	AS6M-3Y2P
		Spring return from right to center	DPDT AS6M-31Y2	AS6M-31Y2P
		Spring return two-way	DPDT AS6M-33Y2	AS6M-33Y2P
	 Square AS6Q-□Y	90° 2-position	Maintained	SPDT AS6Q-2Y1
Spring return from right to left			DPDT AS6Q-2Y2	AS6Q-2Y2P
45° 3-position		Maintained	DPDT AS6Q-3Y2	AS6Q-3Y2P
		Spring return from right to center	DPDT AS6Q-31Y2	AS6Q-31Y2P
		Spring return two-way	DPDT AS6Q-33Y2	AS6Q-33Y2P
 Rectangular AS6H-□Y		90° 2-position	Maintained	SPDT AS6H-2Y1
	Spring return from right to left		DPDT AS6H-2Y2	AS6H-2Y2P
	45° 3-position	Maintained	DPDT AS6H-3Y2	AS6H-3Y2P
		Spring return from right to center	DPDT AS6H-31Y2	AS6H-31Y2P
		Spring return two-way	DPDT AS6H-33Y2	AS6H-33Y2P

- Bezel: black
- Knob: black

Package Quantity: 1

Position	Operation	Contact Operation		
		← Left	↑ Center	→ Right
90° 2-position	Maintained	SPDT		
	Spring return from right	DPDT		
45° 3-position	Maintained	DPDT		
	Spring return from right	DPDT		
	Spring return from left	DPDT		
	Two-way return	DPDT		

- APEM
- Switches & Pilot Lights
- Control Boxes
- Emergency Stop Switches
- Enabling Switches
- Safety Products
- Explosion Proof
- Terminal Blocks
- Relays & Sockets
- Circuit Protectors
- Power Supplies
- LED Illumination
- Controllers
- Operator Interfaces
- Sensors
- AUTO-ID
- Flush Silhouette
- ø16
- ø22
- ø30
- Miniature
- Pilot Lights



ERMEC, S.L. BARCELONA
C/ Francesc Teixido, 22
08918 Badalona SPAIN

Tel. +34 902 450 160
info@ermec.com
www.ermec.com

ERMEC, S.L. - MADRID
C/ Puerto Rico, 4
28222 Majadahonda (Madrid) SPAIN

bilbao@ermec.com
portugal@ermec.com

Dimensions (Selector Switches)

All dimensions in mm.

Dimensions

All dimensions in mm.

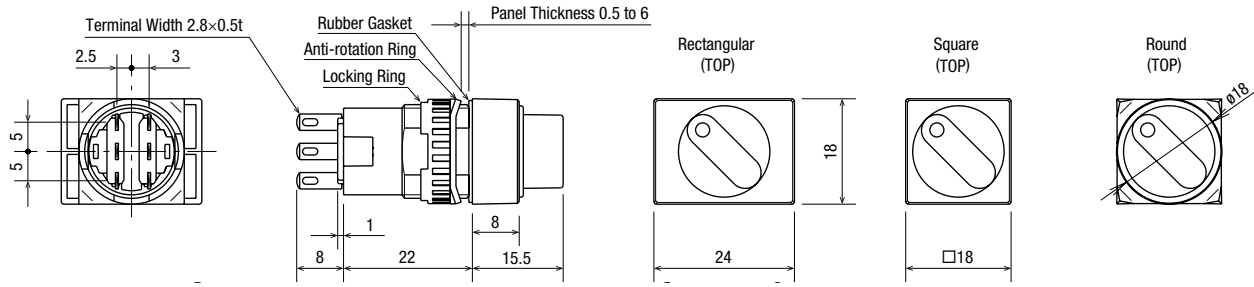

(Selector Switch)

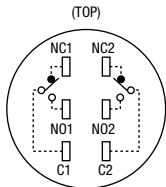

SPDT has NC1, NO1, and C1 only.

Round/Square

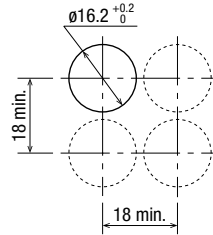

Rectangular

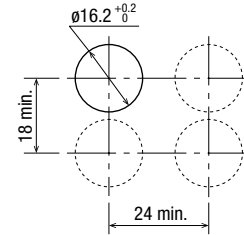

Note: Determine mounting centers to ensure easy operation.

- APEM
- Switches & Pilot Lights
- Control Boxes
- Emergency Stop Switches
- Enabling Switches
- Safety Products
- Explosion Proof
- Terminal Blocks
- Relays & Sockets
- Circuit Protectors
- Power Supplies
- LED Illumination
- Controllers
- Operator Interfaces
- Sensors
- AUTO-ID
- Flush Silhouette
- ø16
- ø22
- ø30
- Miniature
- Pilot Lights

LB

A6



ERMEC, S.L. BARCELONA
 C/ Francesc Teixido, 22
 08918 Badalona SPAIN



















Tel. +34 902 450 160
 info@ermec.com
 www.ermec.com

ERMEC, S.L. - MADRID
 C/ Puerto Rico, 4
 28222 Majadahonda (Madrid) SPAIN

bilbao@ermec.com
 portugal@ermec.com



Key Selector Switches

Package Quantity: 1

Shape	Position	Operation	Key Retained at ●	Contact	Part No.								
					IP40	IP65							
Round AS6M 	90° 2-position	Maintained	A		SPDT	AS6M-2KT1A	AS6M-2KT1PA						
					DPDT	AS6M-2KT2A	AS6M-2KT2PA						
			B		SPDT	AS6M-2KT1B	AS6M-2KT1PB						
					DPDT	AS6M-2KT2B	AS6M-2KT2PB						
			C		SPDT	AS6M-2KT1C	AS6M-2KT1PC						
					DPDT	AS6M-2KT2C	AS6M-2KT2PC						
		Spring return from right		B		SPDT	AS6M-21KT1B	AS6M-21KT1PB					
					DPDT	AS6M-21KT2B	AS6M-21KT2PB						
	45° 3-position			Maintained		A		DPDT	AS6M-3KT2A	AS6M-3KT2PA			
						B		DPDT	AS6M-3KT2B	AS6M-3KT2PB			
						C		DPDT	AS6M-3KT2C	AS6M-3KT2PC			
						D		DPDT	AS6M-3KT2D	AS6M-3KT2PD			
		E				DPDT	AS6M-3KT2E	AS6M-3KT2PE					
		G				DPDT	AS6M-3KT2G	AS6M-3KT2PG					
			Spring return from right		B		DPDT	AS6M-31KT2B	AS6M-31KT2PB				
						D		DPDT	AS6M-31KT2D	AS6M-31KT2PD			
						G		DPDT	AS6M-31KT2G	AS6M-31KT2PG			
		Spring return from left					C		DPDT	AS6M-32KT2C	AS6M-32KT2PC		
									D		DPDT	AS6M-32KT2D	AS6M-32KT2PD
									H		DPDT	AS6M-32KT2H	AS6M-32KT2PH
Spring return two-way				D				DPDT	AS6M-33KT2D	AS6M-33KT2PD			

- Key is retained at ● positions and removable at ○ positions.
- Two keys are supplied.
- The front of key cylinder is made of metal.
- Only one type of key is available



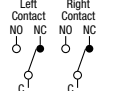
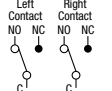
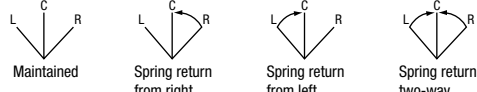
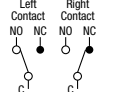
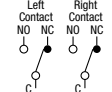
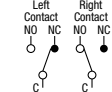















Contact Operation

Operator Position & Contact Operation (Top View)					
Positions		Contact	↙ Left	↑ Center	↘ Right
90° 2-position		SPDT		—	
		DPDT		—	
45° 3-position		DPDT			

- APEM
- Switches & Pilot Lights
- Control Boxes
- Emergency Stop Switches
- Enabling Switches
- Safety Products
- Explosion Proof
- Terminal Blocks
- Relays & Sockets
- Circuit Protectors
- Power Supplies
- LED Illumination
- Controllers
- Operator Interfaces
- Sensors
- AUTO-ID
- Flush Silhouette
- ø16
- ø22
- ø30
- Miniature
- Pilot Lights













Key Selector Switches

Package Quantity: 1

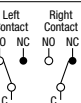
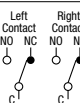
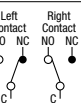
Shape	Position	Operation	Key Retained at ●	Contact	Part No.		
					IP40	IP65	
	90° 2-position	Maintained	A		SPDT	AS6Q-2KT1A	AS6Q-2KT1PA
			B		SPDT	AS6Q-2KT1B	AS6Q-2KT1PB
			C		SPDT	AS6Q-2KT1C	AS6Q-2KT1PC
		Spring return from right	B		SPDT	AS6Q-21KT1B	AS6Q-21KT1PB
					DPDT	AS6Q-2KT2A	AS6Q-2KT2PA
					DPDT	AS6Q-2KT2B	AS6Q-2KT2PB
	45° 3-position	Maintained	A		DPDT	AS6Q-3KT2A	AS6Q-3KT2PA
			B		DPDT	AS6Q-3KT2B	AS6Q-3KT2PB
			C		DPDT	AS6Q-3KT2C	AS6Q-3KT2PC
			D		DPDT	AS6Q-3KT2D	AS6Q-3KT2PD
			E		DPDT	AS6Q-3KT2E	AS6Q-3KT2PE
			G		DPDT	AS6Q-3KT2G	AS6Q-3KT2PG
		Spring return from right	B		DPDT	AS6Q-31KT2B	AS6Q-31KT2PB
			D		DPDT	AS6Q-31KT2D	AS6Q-31KT2PD
			G		DPDT	AS6Q-31KT2G	AS6Q-31KT2PG
		Spring return from left	C		DPDT	AS6Q-32KT2C	AS6Q-32KT2PC
			D		DPDT	AS6Q-32KT2D	AS6Q-32KT2PD
			H		DPDT	AS6Q-32KT2H	AS6Q-32KT2PH
		Spring return two-way	D		DPDT	AS6Q-33KT2D	AS6Q-33KT2PD

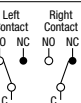
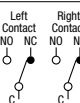
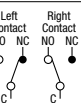
- Key is retained at ● positions and removable at ○ positions.
- Two keys are supplied.
- The front of key cylinder is made of metal.
- Only one type of key is available.

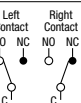
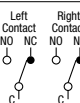
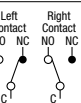
Contact Operation

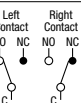
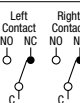
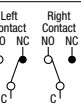
Operator Position & Contact Operation (Top View)					
Positions		Contact	Left	Center	Right
90° 2-position		SPDT		—	
				—	
45° 3-position		DPDT			
					
					
					



ERMEC, S.L. BARCELONA
C/ Francesc Teixidó, 22
08918 Badalona SPAIN



















Tel. +34 902 450 160
info@ermec.com
www.ermec.com

ERMEC, S.L. - MADRID
C/ Puerto Rico, 4
28222 Majadahonda (Madrid) SPAIN

bilbao@ermec.com
portugal@ermec.com







Key Selector Switches

Package Quantity: 1

Shape	Position	Operation	Key Retained at ●	Contact	Part No.				
					IP40	IP65			
	90° 2-position	Maintained	A		SPDT	AS6H-2KT1A	AS6H-2KT1PA		
					DPDT	AS6H-2KT2A	AS6H-2KT2PA		
			B		SPDT	AS6H-2KT1B	AS6H-2KT1PB		
					DPDT	AS6H-2KT2B	AS6H-2KT2PB		
			C		SPDT	AS6H-2KT1C	AS6H-2KT1PC		
					DPDT	AS6H-2KT2C	AS6H-2KT2PC		
		Spring return from right		B		SPDT	AS6H-21KT1B	AS6H-21KT1PB	
				DPDT	AS6H-21KT2B	AS6H-21KT2PB			
	45° 3-position		Maintained	A		DPDT	AS6H-3KT2A	AS6H-3KT2PA	
				B		DPDT	AS6H-3KT2B	AS6H-3KT2PB	
				C		DPDT	AS6H-3KT2C	AS6H-3KT2PC	
				D		DPDT	AS6H-3KT2D	AS6H-3KT2PD	
		E			DPDT	AS6H-3KT2E	AS6H-3KT2PE		
		G			DPDT	AS6H-3KT2G	AS6H-3KT2PG		
			Spring return from right		B		DPDT	AS6H-31KT2B	AS6H-31KT2PB
					D		DPDT	AS6H-31KT2D	AS6H-31KT2PD
					G		DPDT	AS6H-31KT2G	AS6H-31KT2PG
			Spring return from left		C		DPDT	AS6H-32KT2C	AS6H-32KT2PC
					D		DPDT	AS6H-32KT2D	AS6H-32KT2PD
					H		DPDT	AS6H-32KT2H	AS6H-32KT2PH
		Spring return two-way		D		DPDT	AS6H-33KT2D	AS6H-33KT2PD	

- Key is retained at ● positions and removable at ○ positions.
- Two keys are supplied.
- The front of key cylinder is made of metal.
- Only one type of key is available.

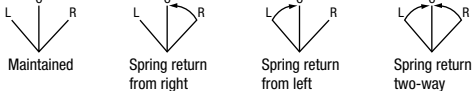
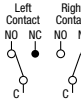
Contact Operation

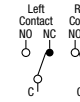
Operator Position & Contact Operation (Top View)				
Positions	Contact	Left	Center	Right
90° 2-position			—	
			—	
45° 3-position				

APEM

Switches & Pilot Lights

Control Boxes

Emergency Stop Switches

Enabling Switches

Safety Products

Explosion Proof

Terminal Blocks

Relays & Sockets

Circuit Protectors

Power Supplies

LED Illumination

Controllers

Operator Interfaces

Sensors

AUTO-ID

Flush Silhouette

ø16

ø22

ø30

Miniature

Pilot Lights

Dimensions

All dimensions in mm.

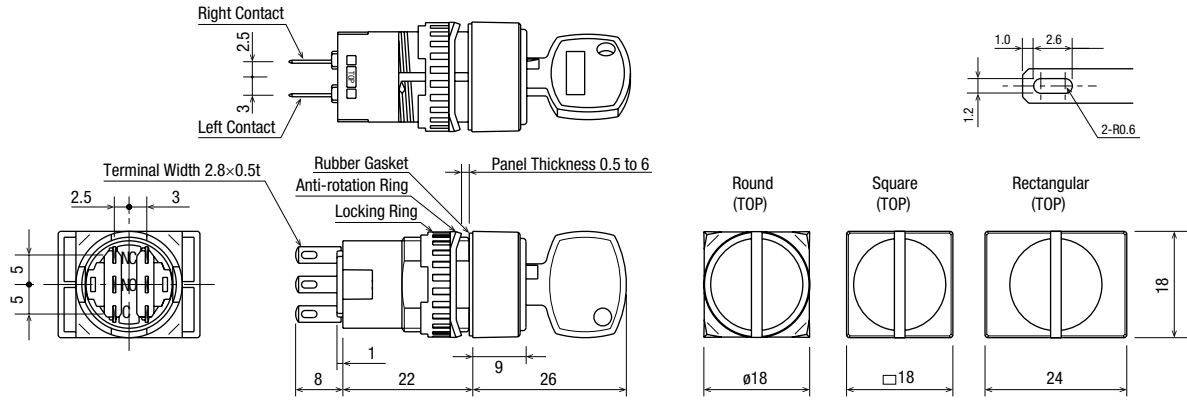

Mounting Hole Layout

Round/Square

Rectangular

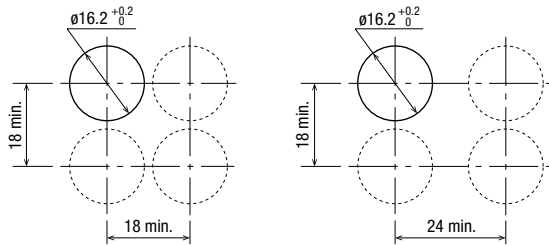

Note: Determine mounting centers to ensure easy operation.

**Terminal Arrangement (bottom view)
(Key Selector Switch)**

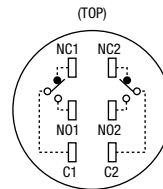

SPDT has NC1, NO1, and C1 only.

Spare Key

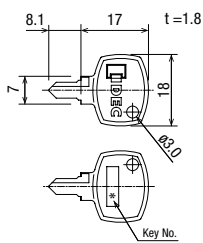

- APEM
- Switches & Pilot Lights
- Control Boxes
- Emergency Stop Switches
- Enabling Switches
- Safety Products
- Explosion Proof
- Terminal Blocks
- Relays & Sockets
- Circuit Protectors
- Power Supplies
- LED Illumination
- Controllers
- Operator Interfaces
- Sensors
- AUTO-ID

- Flush Silhouette
- ø16
- ø22
- ø30
- Miniature
- Pilot Lights

LB

A6



ERMEC, S.L. BARCELONA
C/ Francesc Teixidó, 22
08918 Badalona SPAIN

Tel. +34 902 450 160
info@ermec.com
www.ermec.com

ERMEC, S.L. - MADRID
C/ Puerto Rico, 4
28222 Majadahonda (Madrid) SPAIN

bilbao@ermec.com
portugal@ermec.com

APEM

Switches & Pilot Lights

Control Boxes

Emergency Stop Switches

Enabling Switches

Safety Products

Explosion Proof

Terminal Blocks

Relays & Sockets

Circuit Protectors

Power Supplies

LED Illumination

Controllers

Operator Interfaces

Sensors

AUTO-ID

Flush Silhouette

ø16

ø22

ø30

Miniature

Pilot Lights

LB

A6

Accessories

All dimensions in mm.

Shape		Material	Part No.	Ordering No.	Package Quantity	Remarks	
Locking Ring Wrench 		Metal (nickel-plated brass)	MT-001	MT-001	1	• Used to tighten the locking ring when installing A6 control units into a panel.	
Lamp Holder Tool 		Rubber	OR-77	OR-77	1	• Used to install and remove the LED lamps.	
Lens Removal Tool 		Stainless Steel	MT-101	MT-101	1	• Used to install and remove lenses and buttons.	
Switch Guard	[Remains open] For pushbuttons, illuminated pushbuttons 	Guard (polyacetal) Cover (polyarylate) See B-161 for dimensions.	LB9Z-K2	LB9Z-K2	1	• Degree of protection: IP40 • Used to protect pushbuttons from inadvertent operation.	
	For round/ square units (110°, 180°) For rectangular units (remains 110°, 180°) 		LB9Z-K3P	LB9Z-K3P	1	• Degree of protection: IP65 • Used to protect pushbuttons from inadvertent operation.	
	[Spring return] For pushbuttons, illuminated pushbuttons 	For round/ square units (180°) For rectangular units (180°) 	AL-K6S	AL-K6S	1	• Degree of protection: IP40 • Used to protect pushbuttons from inadvertent operation.	
			AL-K6SP	AL-K6SP	1	• Degree of protection: IP65 (when used with IP65 control units) • Used to protect pushbuttons from inadvertent operation.	
			AL-KH6S	AL-KH6S	1	• Degree of protection: IP40 • Used to protect pushbuttons from inadvertent operation.	
			AL-KH6SP	AL-KH6SP	1	• Degree of protection: IP65 (when used with IP65 control units) • Used to protect pushbuttons from inadvertent operation.	
Dust Cover 		Translucent cover: elastomer Black part: polypropylene	① For round units	AL-D6	AL-D6	1	• When mounting the control units with the dust covers installed, refer to mounting hole layout on B-162. • Operating temperature: -10 to +55°C
	② For square units		AL-DQ6	AL-DQ6	1		
	③ For rectangular units		AL-DH6	AL-DH6	1		
Terminal Cover 		Polyamide (white) See B-162 for dimensions.	AL-V6	AL-V6PN10	10	• When wiring the terminals, insert the lead wires into the terminal cover holes before soldering. • Terminal cover is not attached and must be ordered separately.	
Socket 		See B-162 for dimensions.	① Solder Terminal	AL-C6	AL-C6	1	• Plugs on the rear of the A series control units.
	② PC Board Terminal		AL-C6V	AL-C6V	1		
Mounting Hole Plug 		Rubber	Nitril rubber (black)	AL-B6	AL-B6PN05	5	• Degree of protection: IP65 
Mounting Hole Plug 		Metal	Plug: metal (diecast) Locking ring: polyacetal Gasket: nitrile	AL-BM6	AL-BM6	1	• Degree of protection: IP65 • Tightening torque: 0.1 to 0.29 N-m. 

Dimensions

All dimensions in mm.

Switch Guard

[Remains open]

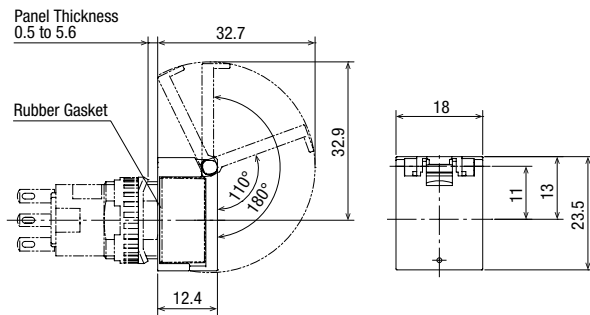
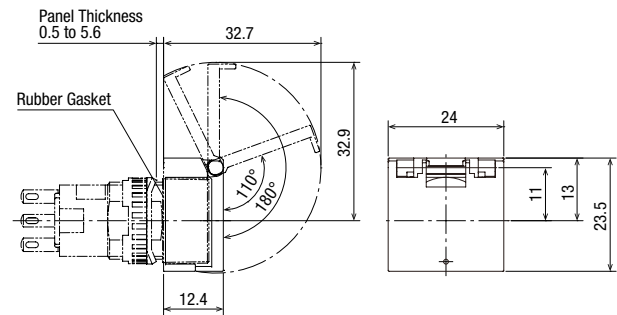
For round/square units (Degree of protection: IP40)
LB9Z-K2For rectangular units (Degree of protection: IP65)
LB9Z-K3P

[Spring return]

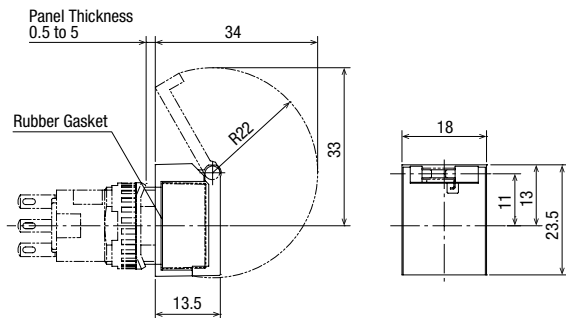
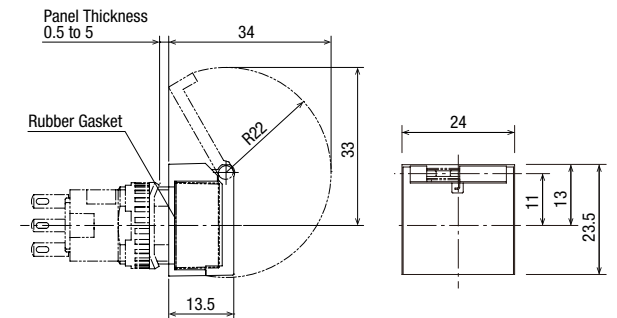
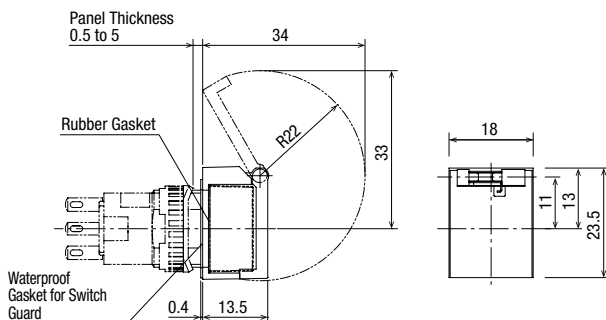
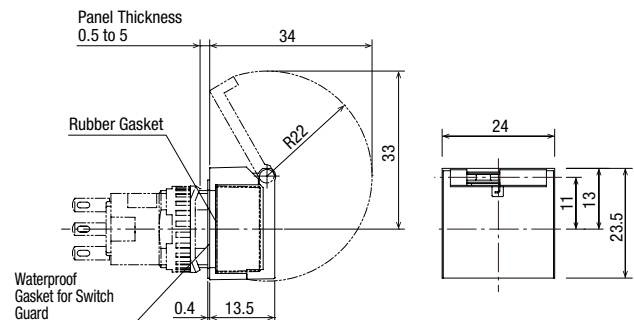
For round/square units (Degree of protection: IP40)
AL-K6SFor rectangular units (Degree of protection: IP40)
AL-KH6SFor round/square units (Degree of protection: IP65)
AL-K6SPFor rectangular units (Degree of protection: IP65)
AL-KH6SP

APEM

Switches & Pilot Lights

Control Boxes

Emergency Stop Switches

Enabling Switches

Safety Products

Explosion Proof

Terminal Blocks

Relays & Sockets

Circuit Protectors

Power Supplies

LED Illumination

Controllers

Operator Interfaces

Sensors

AUTO-ID

Flush Silhouette

ø16

ø22

ø30

Miniature

Pilot Lights

LB

A6

Dimensions

All dimensions in mm.

Socket

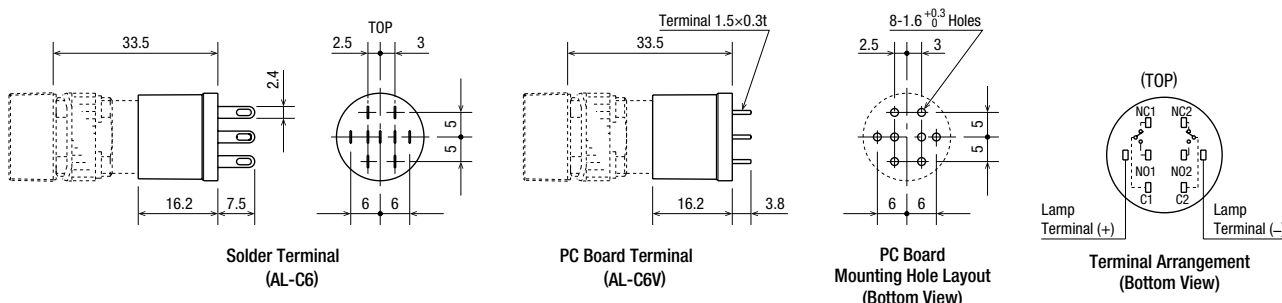

Terminal Cover

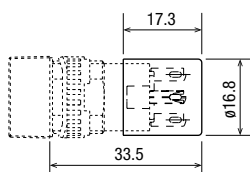

Note: When wiring the terminals, insert the lead wires into the terminal cover holes before soldering.

Dust Cover

For Round Units (AL-D6)

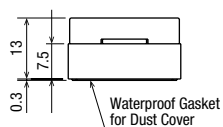
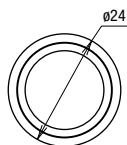

For Square Units (AL-DQ6)

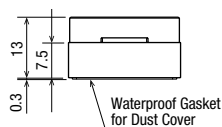
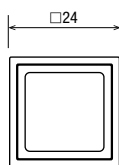

For Rectangular Units (AL-DH6)

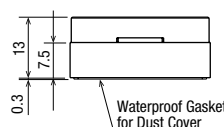
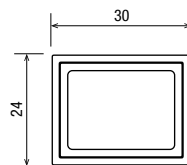

Mounting Hole Centers

Round/Square Units

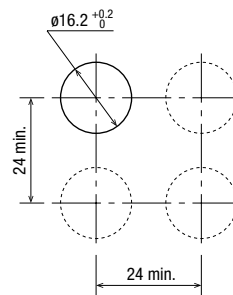

Rectangular Units

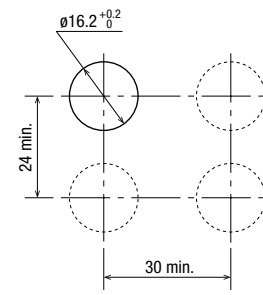

Large Lens and Large Button

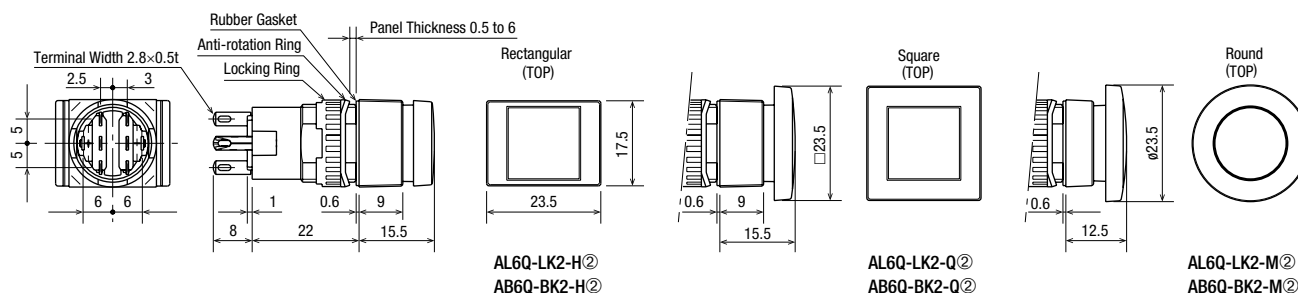

- APEM
- Switches & Pilot Lights
- Control Boxes
- Emergency Stop Switches
- Enabling Switches
- Safety Products
- Explosion Proof
- Terminal Blocks
- Relays & Sockets
- Circuit Protectors
- Power Supplies
- LED Illumination
- Controllers
- Operator Interfaces
- Sensors
- AUTO-ID
- Flush Silhouette
- ø16
- ø22
- ø30
- Miniature
- Pilot Lights

LB
A6



ERMEC, S.L. BARCELONA
C/ Francesc Teixidó, 22
08918 Badalona SPAIN

Tel. +34 902 450 160
info@ermec.com
www.ermec.com

ERMEC, S.L. - MADRID
C/ Puerto Rico, 4
28222 Majadahonda (Madrid) SPAIN

bilbao@ermec.com
portugal@ermec.com

Grip Switch Housing

Grip Style Enabling Switch Housing

The following switches can be installed on the grip style enabling switch housing to be used as hand-held switches.

- AB6M pushbuttons (IP65, except for AB6M-V)
- AS6M selector switches (IP65)
- AS6M key selector switches (IP65)

Note: Illuminated pushbuttons and pilot lights cannot be used. When using HE9Z-GSH51, be sure to use IP65 switches.

Part No.	Ordering No.	Package Quantity
HE9Z-GSH51	HE9Z-GSH51	1

Specifications

Applicable Standards	IEC/EN 60529
Operating Temperature	-25 to 60°C (no freezing)
Relative Humidity	45 to 85% RH (no condensation)
Storage Temperature	-40 to 80°C (no freezing)
Pollution Degree	3
Shock Resistance	Damage limits: 500 m/s ²
Vibration Resistance	Damage limits: 5 to 55 Hz, amplitude 0.5 mm
Electric Shock Protection Class	Class II (when using HE5B-M2P*)
Applicable Cable	Outside diameter ø4.5 to 10 mm
Conduit Port Size	M16 (cable gland is supplied with the grip style enabling switch housing)
Degree of Protection	IP65 (with HE5B-M2P*) NEMA type 4X indoor use only (with HE5B-M2P*)
Weight (approx.)	65g (grip style enabling switch housing only)

- The above specifications are for the grip style enabling switch housing only.



Notes:

- The HE9Z-GSH51 grip style enabling switch housing does not include the HE5B enabling switch. The enabling switch must be ordered separately.
- The HE5B enabling switch must be installed and wired to the HE9Z-GSH51 grip style enabling switch housing by the user. For information on wiring, see the instruction sheet supplied with the HE9Z-GSH51.

Dimensions

HE9Z-GSH51

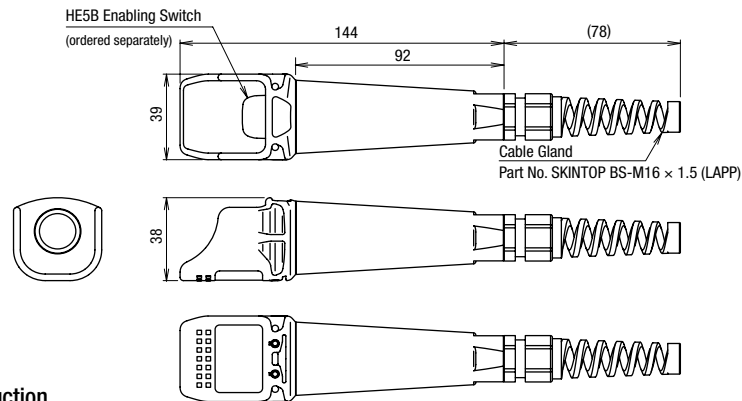

HE9Z-GSH51 + HE5B Construction

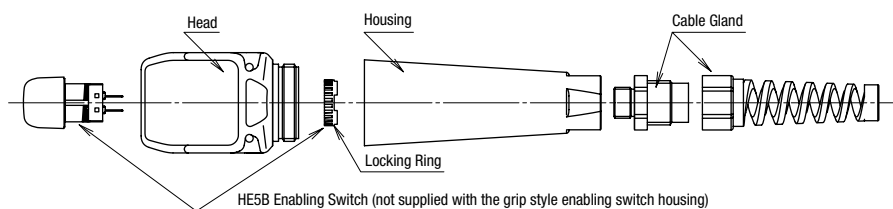

- Anti-rotation ring is not required when installing the HE5B enabling switch on the HE9Z-GSH51 grip style enabling switch housing. Use the locking ring only.

Mounting Bracket

Part No: HE9Z-GH1

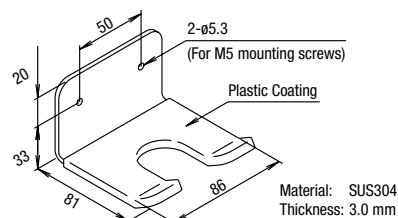

All dimensions in mm.

APEM

Switches & Pilot Lights

Control Boxes

Emergency Stop Switches

Enabling Switches

Safety Products

Explosion Proof

Terminal Blocks

Relays & Sockets

Circuit Protectors

Power Supplies

LED Illumination

Controllers

Operator Interfaces

Sensors

AUTO-ID

Flush Silhouette

ø16

ø22

ø30









Miniature

Pilot Lights

LB

A6

Maintenance Parts

Shape		Specification		Part No.	Ordering No.	Package Quantity	Remarks														
	Round	Polyarylate		AL6M-L②	AL6M-L②PN05	5	Specify a color code in place of ② in the Part No. A (amber), C (clear), G (green) R (red), S (blue), Y (yellow) • Use a C (clear) lens for JW (pure white) illumination.														
	Square			AL6Q-L②	AL6Q-L②PN05																
	Rectangular			AL6H-L②	AL6H-L②PN05																
	Round	Polyarylate		AB6M-B①	AB6M-B①PN05			5	Specify a color code in place of ① in the Part No. B (black), G (green), R (red) S (blue), W (white), Y (yellow)												
	Square			AB6Q-B①	AB6Q-B①PN05																
	Rectangular			AB6H-B①	AB6H-B①PN05																
	Round	Acrylic	White	AL6M-W	AL6M-WPN05			5													
			Black	AL6M-B	AL6M-BPN05																
	Square		White	AL6Q-W	AL6Q-WPN05																
			Black	AL6Q-B	AL6Q-BPN05																
	Rectangular		White	AL6H-W	AL6H-WPN05																
			Black	AL6H-B	AL6H-BPN05																
	Round (installed on round units)	Translucent color lens		AL6M-LK2-M②	AL6M-LK2-M②	1	<ul style="list-style-type: none"> Specify a color code in place of ② in the Part No. Degree of protection: IP65 ② Color Code <table border="1" data-bbox="1106 1059 1433 1216"> <thead> <tr> <th>Translucent Color Lens</th> <th>Opaque Button</th> </tr> </thead> <tbody> <tr> <td>A (amber)</td> <td>B (black)</td> </tr> <tr> <td>G (green)</td> <td>G (green)</td> </tr> <tr> <td>R (red)</td> <td>R (red)</td> </tr> <tr> <td>S (blue)</td> <td>S (blue)</td> </tr> <tr> <td>W (white)</td> <td>W (white)</td> </tr> <tr> <td>Y (yellow)</td> <td>Y (yellow)</td> </tr> </tbody> </table> Note: Use a white (W) translucent color lens for pure white (JW) illumination. • See B-162 for dimensions.	Translucent Color Lens	Opaque Button	A (amber)	B (black)	G (green)	G (green)	R (red)	R (red)	S (blue)	S (blue)	W (white)	W (white)	Y (yellow)	Y (yellow)
		Translucent Color Lens	Opaque Button																		
	A (amber)	B (black)																			
	G (green)	G (green)																			
	R (red)	R (red)																			
	S (blue)	S (blue)																			
W (white)	W (white)																				
Y (yellow)	Y (yellow)																				
Opaque button		AB6M-BK2-M②	AB6M-BK2-M②																		
Square (installed on square units)	Translucent color lens		AL6Q-LK2-Q②	AL6Q-LK2-Q②																	
	Opaque button		AB6Q-BK2-Q②	AB6Q-BK2-Q②																	
Rectangular (installed on square units)	Translucent color lens		AL6Q-LK2-H②	AL6Q-LK2-H②																	
	Opaque button		AB6Q-BK2-H②	AB6Q-BK2-H②																	
		Polyacetal	HA9Z-LN	HA9Z-LNPN10	10	<ul style="list-style-type: none"> Black 															
		Stainless Steel	LB9Z-LP1	LB9Z-LP1PN10																	
	Key selector (disc tumbler key)	Brass with nickel plating	AS6-SK-132	AS6-SK-132PN02	2	<ul style="list-style-type: none"> Thickness 1.8 mm 															
	Key selector (wave key)	Diecast zinc alloy (nickel-plated)	LA9Z-SK-□	LA9Z-SK-□PN02	2	<ul style="list-style-type: none"> Specify a key number in place of □ in the Part No. 0H: Standard key (reversible) 1H to 2H: Reversible key 3H to 6H: Non-reversible key															
		Rubber	AP6M-WM	AP6M-WMPN10	10																

ø16 A6 Series Miniature Switches and Pilot Lights

LED Lamps

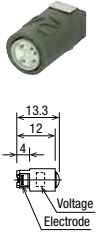
Dimensions	Operating Voltage	Current Draw		Part No.	Ordering No.	② Illumination Color Code	Package Quantity	Base
		AC	DC					
	5V DC ±5%	—	8 mA	LATD-5②	LATD-5② LATD-5②PN10	Specify a color code in place of ② in the Ordering No. A: amber G: green JW: pure white R: red S: blue W: white	1	Exclusive for A6 series
	6V DC ±5%	7 mA (G, S, JW) 8 mA (A, R, W)	5 mA (G, S, JW) 6 mA (A, R, W)	LATD-6②	LATD-6② LATD-6②PN10		10	
	12V AC/DC ±10%	9 mA	8 mA	LATD-1②	LATD-1② LATD-1②PN10		1	
	24V AC/DC ±10%	9 mA	8 mA	LATD-2②	LATD-2② LATD-2②PN10		10	
							1	
							10	

- Use a pure white (JW) LED lamp for yellow illumination

Transformer

Package Quantity: 1

Transformer	Primary Voltage	Secondary Voltage	Part No. (Ordering No.)	Applicable LED
	100/110V AC	±10%	TWR512	LATD-2②
	200/220V AC	±10%	TWR522	
	400/440V AC	±10%	TWR542	

- Terminal cover is supplied as standard.
- Connect only one LATD to a transformer.

Specifications

Operating Voltage	100/110V AC, 200/220V AC, 400/440V AC (50/60Hz)
Current Draw	2.4VA
Rated Insulation Voltage	600V
Insulation Resistance	100 MΩ minimum (500V DC megger)
Operating Temperature	-30 to +60°C (no freezing)
Storage Temperature	-40 to +80°C (no freezing)
Operating Humidity	35 to 85% RH (no condensation)
Vibration Resistance	Damage limits: 30Hz, amplitude 1.5 mm Operating extremes: 5 to 55Hz, amplitude 0.5 mm
Shock Resistance	Damage limits: 1,000 m/s ² Operating extremes: 100 m/s ²
Dielectric Strength	2,500V AC, 1 minute
Terminal Screw	M3.5
Applicable Wire	2 mm ² maximum, 2 wires maximum
Weight (approx.)	87g

Dimensions

All dimensions in mm.

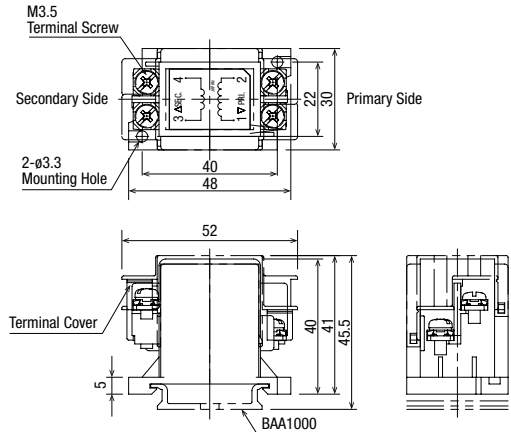

Accessories

When ordering, specify the Ordering No.

Shape	Material	Part No.	Ordering No.	Package Quantity
DIN 35 mm Rail Weight: 200g approx	Aluminum Length: 1000 mm	BAA1000	BAA1000PN10	10
DIN 35 mm Rail Weight: 320g approx	Steel Length: 1000 mm	BAP1000	BAP1000PN10	10
End Clip  Weight: 15g approx	Metal (zinc-plated steel) Applicable rail: BAA1000, BAP1000	BNL6	BNL6PN10	10

- See H-071 for DIN rail products.



ERMEC, S.L. BARCELONA
C/ Francesc Teixidó, 22
08918 Badalona SPAIN

Tel. +34 902 450 160
info@ermec.com
www.ermec.com

ERMEC, S.L. - MADRID
C/ Puerto Rico, 4
28222 Majadahonda (Madrid) SPAIN

bilbao@ermec.com
portugal@ermec.com

APEM

Switches & Pilot Lights

Control Boxes

Emergency Stop Switches

Enabling Switches

Safety Products

Explosion Proof

Terminal Blocks

Relays & Sockets

Circuit Protectors

Power Supplies

LED Illumination

Controllers

Operator Interfaces

Sensors

AUTO-ID

Flush Silhouette

ø16

ø22

ø30

Miniature

Pilot Lights

LB

A6

Safety Precautions

- Turn off the power to A series control units before starting installation, removal, wiring, maintenance, and inspection of the control units. Failure to turn power off may cause electrical shocks or fire hazard.
- To avoid a burn on your hand, use the lamp holder tool when replacing lamps.

- For wiring, use wires of a proper size to meet the voltage and current requirements. Failure to tighten terminal screws may cause overheating and create a fire hazard.

Operating Instructions

All dimensions in mm.

Replacement of Lens and Marking Plate

Removal

Remove the lens assembly (color lens, marking plate, lens holder, and spring) by holding the color lens recesses with the Lens Removal Tool (MT-101) and pulling it out. Remove the marking plate by disengaging the latches between the color lens and lens holder.

The marking plate must be engraved on the front side as shown at right.

When using a color film, insert it between the color lens and marking plate.

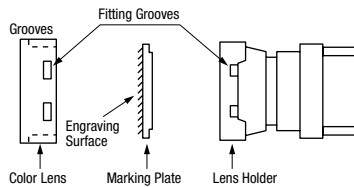

Installation

Place the marking plate on the lens holder in the correct direction, and press the color lens onto the lens holder to engage the latches. Put the spring on the lens holder and insert the lens holder into the housing in the correct direction.

Marking

For A series illuminated pushbuttons, legends and symbols can be engraved under the lens for labelling purposes.

Marking Plate & Engraving Area

	Round	Square	Rectangular
Built-in Marking Plate and Engraving Area			
	<ul style="list-style-type: none"> • Engraving must be made on the engraving area within 0.5mm deep. • The marking plate is made of white acrylic resin. 		
Applicable Marking Film (not supplied)			
	<ul style="list-style-type: none"> • Thickness = 0.1 mm × 1 film • Recommended film material: polyester 		

Replacing the LED Lamp

Removal

Use the lamp holder tool (OR-77) to remove lamps. Do not use pliers.

Installation

Use the lamp holder tool (OR-77) to install lamps. Note the correct side of the tool for removal or installation.

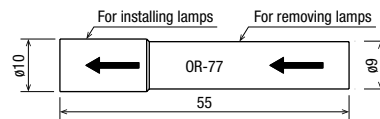

Panel Mounting

When mounting the control units into a panel, use the optional locking ring wrench (MT-001) to tighten the locking ring. Do not use pliers. Tightening torque must not exceed 0.88 N·m. Excessive tightening will damage the locking ring.

Wiring

Solder the terminal at 350°C within 3 seconds using a 60W soldering iron. Sn-Ag-Cu is recommended when using lead-free solder. When soldering, do not touch the control unit with the soldering iron. Also ensure that no tensile force is applied to the terminal. Do not bend the terminal or apply excessive force to the terminal. Use a non-corrosive rosin flux.

Installing the Socket

Install the socket on the control unit with the TOP markings on the control unit and the socket placed in the same direction.

Switch Guard

IP65 (IEC 60529) switch guards must be used with IP65 (IEC 60529) control units only. Even if IP65 type switch guards are installed, enclosed type (IP40) control units are not made waterproof.

Item	Switch Guard		
	IP65 (IEC 60529)	IP65 (IEC 60529)	IP40 (IEC 60529)
Control Unit	IP65	IP65	IP40
	IP40	IP40	IP40

Operating Instructions

All dimensions in mm.

Opening/closing the Switch Guard (LB9Z-K2, LB9Z-K3P)

When opening/closing the switch guard while the switch guard is not installed on a panel, make sure to hold the hinge. Holding the base might result in damage. Also do not apply force on the guard in other than open/close directions, otherwise the hinge may be damaged.

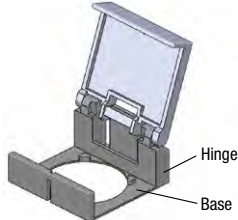

Selector Switches with Key

Observe the following instructions to prevent malfunction or damage.

- Insert the key to the bottom of the key hole.
- Do not remove the key from any key retained position.
- Besides the standard key (key number 0H), six other key numbers are available. Use a key of the matching number with the key cylinder. The standard key does not have a key number indication.

Operating Voltage of LED Lamps

The operating voltage of 5V DC is measured at complete DC.

Other Notes

Close Proximity Mounting

When mounting pilot lights or illuminated pushbuttons collectively or lighting them continuously, heat may cause the ambient temperature to rise above the rated operating temperature. When the mounting panel is not made of metal or when the control units are mounted in an enclosed panel, provide for ventilation or lower the operating voltage.

Replacement of Buttons (Illuminated/Non-illuminated)

Do not replace buttons of maintained action units while the button is in the locked position. Replacing the button in the locked position may damage the internal mechanism. Be sure to release the button before replacing.

Operating and Storage Environment

1. Make sure that the operating/storage temperature and humidity are within the ratings.
2. Do not use enclosed type units in an environment subject to oil, water or dust accumulation. In such an area, use the waterproof/oiltight units (IP65).

Microswitch Contacts

Do not connect NO and NC contacts of a microswitch to different voltages or different power sources to prevent a dead short-circuit.

IP65 Units

IP65 units are evaluated by conventional cutting and cooling oils, and can not be used with some special oils. Contact IDEC for resistance against specific oils.

APEM

Switches & Pilot Lights

Control Boxes

Emergency Stop Switches

Enabling Switches

Safety Products

Explosion Proof

Terminal Blocks

Relays & Sockets

Circuit Protectors

Power Supplies

LED Illumination

Controllers

Operator Interfaces

Sensors

AUTO-ID

Flush Silhouette

ø16

ø22

ø30

Miniature

Pilot Lights

LB

A6



ERMEC, S.L. BARCELONA
C/ Francesc Teixidó, 22
08918 Badalona SPAIN

Tel. +34 902 450 160
info@ermec.com
www.ermec.com

ERMEC, S.L. - MADRID
C/ Puerto Rico, 4
28222 Majadahonda (Madrid) SPAIN

bilbao@ermec.com
portugal@ermec.com

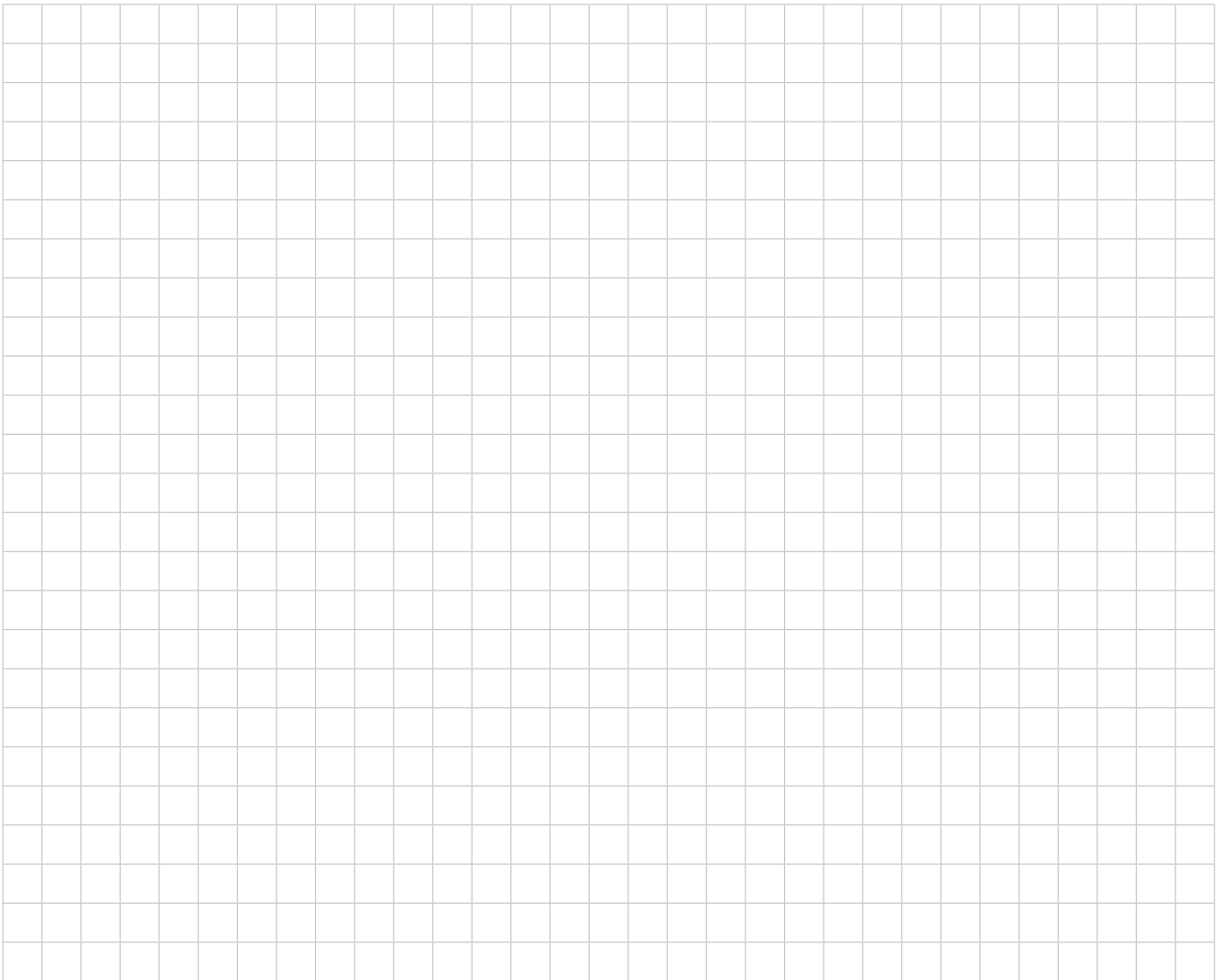

- APEM
- Switches & Pilot Lights
- Control Boxes
- Emergency Stop Switches
- Enabling Switches
- Safety Products
- Explosion Proof
- Terminal Blocks
- Relays & Sockets
- Circuit Protectors
- Power Supplies
- LED Illumination
- Controllers
- Operator Interfaces
- Sensors
- AUTO-ID
- Flush Silhouette
- ø16
- ø22
- ø30
- Miniature
- Pilot Lights
- LB
- A6



ERMEC, S.L. BARCELONA
C/ Francesc Teixidó, 22
08918 Badalona SPAIN

Tel. +34 902 450 160
info@ermec.com
www.ermec.com

ERMEC, S.L. - MADRID
C/ Puerto Rico, 4
28222 Majadahonda (Madrid) SPAIN

bilbao@ermec.com
portugal@ermec.com

Benelux B: (+32) 27 25 05 00 - sales@apem.be
NL: (+31) (70) 799 91 51 - sales@apem.be
France (+33) 5 63 93 14 98 - commercial@apem.fr
Germany Munich: (+49) 89 45 99 11 0 - info@apem.de
Hamburg: (+49) 40 253054 0 - info@apem.de
Italy (+39) 0172 74 3170 - apem.italia@apem.it
Sweden (+46) 8 626 38 00 - info@apem.se
United Kingdom (+44) 1 844 202400 - sales@apem.co.uk

Flush Bezel (Accessories) LB/A6 Series

Flush silhouette bezels for LB/ A6 series switches and pilot lights.

- Accessories for LB (standard bezel) / A6 series.
- Bezel Size
 Round: $\varnothing 24$ mm (Panel Cut-out: $\varnothing 20.2$ mm)
 Square: $\square 24$ mm (Panel Cut-out: $\square 20.2$ mm)
 Rectangular: 24×30 mm (Panel Cut-out: 20.2×26.2 mm)







Applicable models

Series	A6 Series	LB Series (Standard Bezel)
Functions	Illuminated Pushbutton Pilot Light Pushbutton Selector Switch Key Selector Switch	Illuminated Pushbutton Pilot Light Pushbutton Selector Switch Key Selector Switch Illuminated Selector Switch Lever Switch Buzzer

- Cannot be used for large lens units.
- Cannot be used for A6 series 100V / 200V AC illuminated pushbuttons and pilot lights.



Flush Bezel

Shape	Specification	Part No.	Package Quantity	Remarks
Round 	Bezel: Aluminum Gasket: Nitrile rubber Mounting bracket: Stainless steel	LA9Z-SM61	1	<ul style="list-style-type: none"> • Degree of protection: IP65 (only when used with IP65 control units)
Round 		LA9Z-S61B	1	
Square 		LA9Z-S71B	1	
Rectangular 		LA9Z-S81B	1	
Switch Guard with Flush Bezel (Spring Return) Rectangular 	Guard: Polyarylate (transparent) Bezel: Polyamide (black) Gasket: Nitrile Rubber Mounting bracket: Stainless steel	LA9Z-KS8	1	<ul style="list-style-type: none"> • Used for rectangular pushbuttons and illuminated pushbuttons. Cannot be used for selector switches, illuminated selector switches, and lever switches. • Degree of protection: IP65 (only when used with IP65 control units)
Dust Cover	Round 	LA9Z-DS6	1	<ul style="list-style-type: none"> • Dust cover is supplied with a flush bezel. • Degree of protection: IP65 • Applicable type: pushbuttons and illuminated pushbuttons.
	Square 	LA9Z-DS7	1	
	Rectangular 	LA9Z-DS8	1	

- Other than the accessories mentioned above, insulation covers and maintenance parts can also be used. (Except switchguard: AL-K, dust cover: AL-D.)

Shape	Specification	Part No.	Package Quantity	Remarks
Round	Plug: Polyamide (black) Gasket: Nitril rubber Mounting bracket: Stainless steel	LA9Z-BS6	1	• Degree of protection: IP65 • Panel thickness: 0.5 to 5 mm
Square		LA9Z-BS7	1	
Rectangular		LA9Z-BS8	1	

Ordering Information

- LB / A6 series switches and pilot lights are not supplied with flush bezels. Order flush bezels separately.

Specifications

- Based on LB / A6 series specifications.

APEM

Switches & Pilot Lights

Control Boxes

Emergency Stop Switches

Enabling Switches

Safety Products

Explosion Proof

Terminal Blocks

Relays & Sockets

Circuit Protectors

Power Supplies

LED Illumination

Controllers

Operator Interfaces

Sensors

AUTO-ID

Flush Silhouette

ø16

ø22

ø30

Miniature

Pilot Lights

CW

LW-F

LB

LBW

UP

Flush Bezel

Dimensions

All dimensions in mm.

Flush Bezel

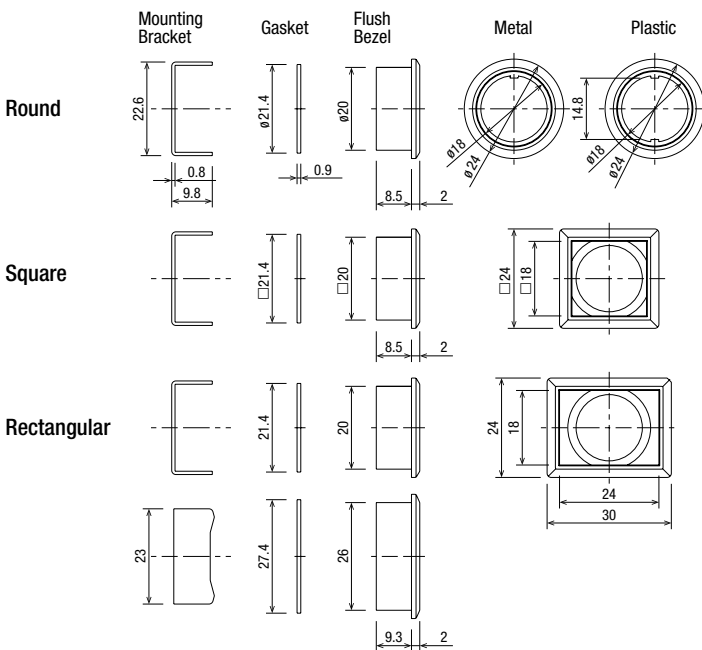

Flush Bezel with Control Units

A6 Series

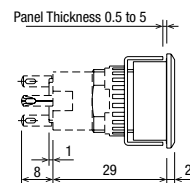

Selector Switch

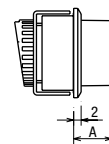

Unit	A (mm)
A6 selector switch	8.5

Key Selector Switch

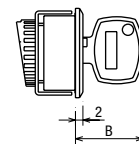

Unit	B (mm)
A6 key selector	18.1

Mounting Hole Layout

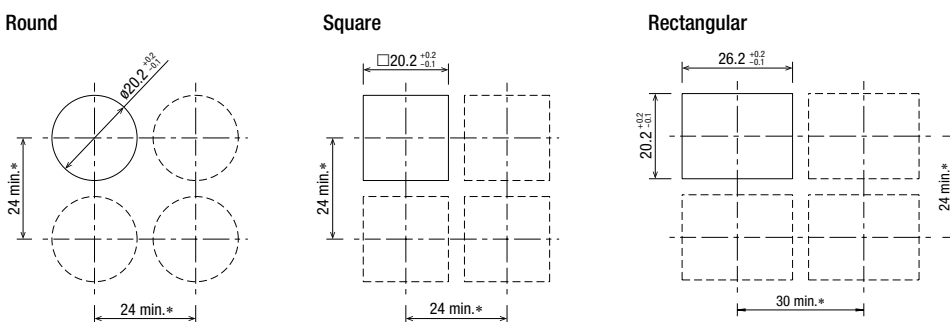

- * When mounting the dust cover:
 Round and square types: 27 mm minimum
 Rectangular type: Vertical 27 mm, Horizontal 33 mm minimum

Dimensions

All dimensions in mm.

Flush Bezel with Switch Guard

A6 Series

[Mounting Hole Layout]

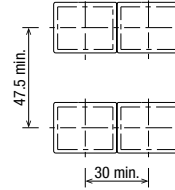
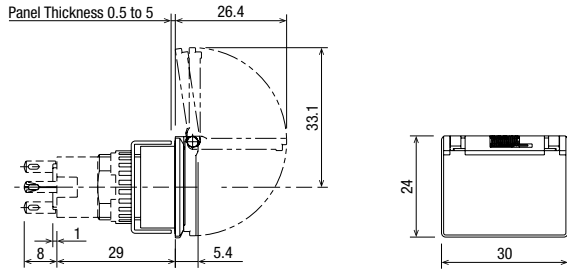

Mounting holes are the same size as rectangular flush bezels.

Mounting Hole Plug

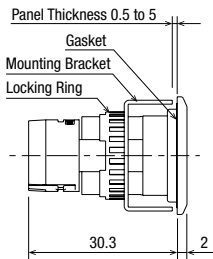

Round

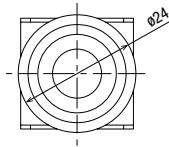

Square

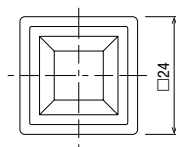

Rectangular

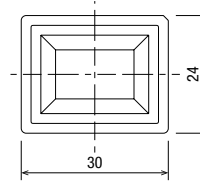

Mounting holes are the same size as flush bezels.

Dust Cover

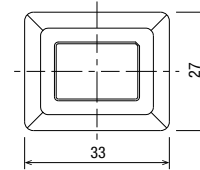
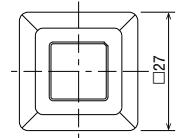
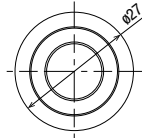
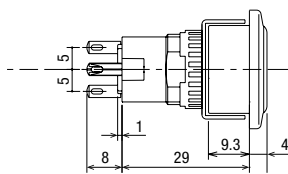

Minimum mounting centers when dust cover is installed:
 Round/square: 27mm minimum
 Rectangular: Vertical 27mm minimum
 Horizontal 33mm minimum

APEM

Switches &
Pilot Lights

Control Boxes

Emergency
Stop SwitchesEnabling
Switches

Safety Products

Explosion Proof

Terminal Blocks

Relays & Sockets

Circuit
Protectors

Power Supplies

LED Illumination

Controllers

Operator
Interfaces

Sensors

AUTO-ID

Flush Silhouette

ø16

ø22

ø30

Miniature

Pilot Lights

CW

LW-F

LB

LBW

UP

Flush Bezel



ERMEC, S.L. BARCELONA
 C/ Francesc Teixidó, 22
 08918 Badalona SPAIN

Tel. +34 902 450 160
 info@ermec.com
 www.ermec.com

ERMEC, S.L. - MADRID
 C/ Puerto Rico, 4
 28222 Majadahonda (Madrid) SPAIN

bilbao@ermec.com
 portugal@ermec.com

Safety Precautions

- Turn off the power to the control units before installation, removal, wiring, maintenance, and inspection. Failure to turn power off may cause electrical shocks or fire hazard.
- To avoid burning your hand, use the lamp holder tool when replacing lamps.

- For wiring, use wires of a proper size to meet voltage and current requirements and solder correctly. Improper soldering may cause overheating and fire hazard. Also, when using tab terminals, use appropriate quick connect receptacles.

Instructions

Panel Mounting of Flush Bezels

1. Remove the locking ring and anti-rotation ring from the operator.
2. Attach the flush bezel to the operator. Then insert the assembly into the panel. Attach the mounting bracket and tighten the locking ring. (Do not use the anti-rotation ring supplied with the operator.) For round flush bezels, place the projection on the bezel to the groove on the TOP side of the operator and mount onto the panel.

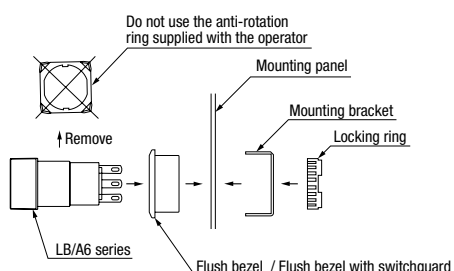

Notes on Panel Mounting

Use a locking ring wrench (MT-001) to mount the operator onto the panel.

Recommended tightening torque is as below:

LB series: 0.5 to 0.7 N·m

A6 series: 0.88 N·m.

Do not use pliers. Excessive tightening will damage the locking ring.

Flush Bezel with Switchguards

Do not apply load on the guard in the direction other than the opening/closing the guard. Otherwise the hinge part will be damaged.

Installing the Dust Cover

Attach the dust cover and the flush bezel to the LB/A6 series operator. Then insert the assembly into the panel. Attach the mounting bracket and tighten the locking ring. Tighten the locking ring to the recommended tightening torque (LB series: 0.5 to 0.7 N·m, A6 series: 0.88N·m). (Do not use the anti-rotation ring supplied with the operator.)

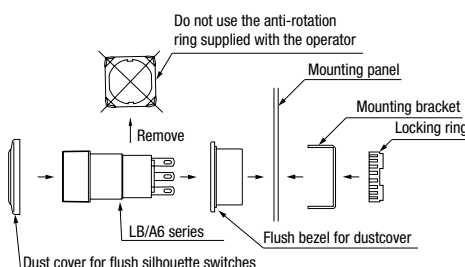

Precautions for Installing the Dust Cover

Install the dust cover to wrap around the entire periphery of the flush bezel. Make sure that the projection on the dust cover is placed into the groove on the back of the bezel. If the projection is not placed correctly, normal waterproof/dustproof characteristics will not apply.

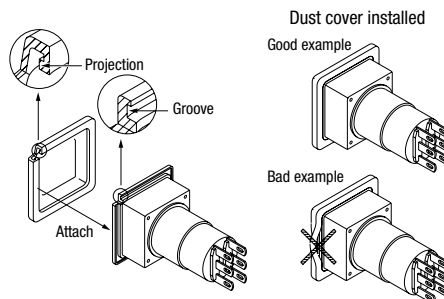

Replacing the Lens

Remove the lens assembly (lens, marking plate, and lens holder) from the operator by holding the lens removal tool (MT-101) and pull out.



- For other instructions, refer to A6 series pages.



Benelux B: (+32) 27 25 05 00 - sales@apem.be
 NL: (+31) (70) 799 91 51 - sales@apem.be
 France (+33) 5 63 93 14 98 - commercial@apem.fr
 Germany Munich: (+49) 89 45 99 11 0 - info@apem.de
 Hamburg: (+49) 40 253054 0 - info@apem.de
 Italy (+39) 0172 74 3170 - apem.italia@apem.it
 Sweden (+46) 8 626 38 00 - info@apem.se
 United Kingdom (+44) 1 844 202400 - sales@apem.co.uk