

X6

X6

- Characteristics
- small size
 - high current
 - PCB mounting
 - compliant to glow wire test IEC 60335-1, 4.ed.

Rating Up to 250 VAC, 3 A

Dimensions (mm) 12.8 × 6.5 × 5.8

- Actuator
- plunger
 - plain lever
 - simulated roller lever/cam follower

Approvals cULus, ENEC



Preferred Range

Ordering Reference	Actuating Force		Sealing	Operating pos.		Terminal	Circuit	Actuator	Contacts	Electrical rating
	(N)	(ozf)		(mm)	(in)					
X6G303K1AA	1,50	5,40	IP40	5,5	0,22	PCB	CO	Plunger	AgNi	250 VAC, 3 A
X6G303K1AAJ1	0,50	1,80	IP40	7,2	0,28	PCB	CO	Plain lever	AgNi	250 VAC, 3 A
X6G303K1AALO	0,65	2,34	IP40	9,6	0,38	PCB	CO	Cam follower	AgNi	250 VAC, 3 A

X6

Specifications

Housing	Frame-retardant glass-fibre reinforced nylon
Plunger	Polyacetal (POM)
Mechanism	Snap-action, coil spring mechanism with stainless steel spring. Single-pole change-over contact
Contacts	AgNi
Terminals	Brass, silver flashed
Temperature range °C	-40°C bis +85°C
Mechanical life	10 ⁶ cycles minimum (impact-free actuation)
Protection	Enclosure IP40
Mounting	PCB, through hole mounting

Circuit diagram

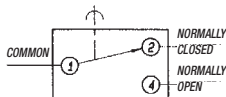

Dimensions

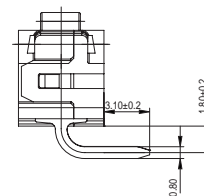
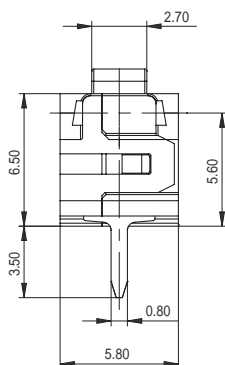
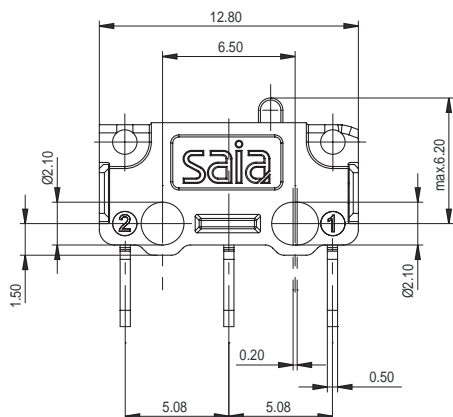

formed to the right

PCB mounting dimensions

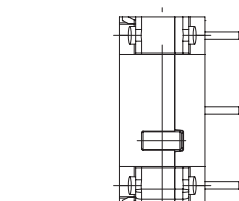
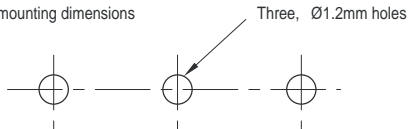

formed to the left

Recommended maximum electrical ratings

Voltage (max)	Resistive load (A)	Approvals
250 VAC	3	UL1054/CSA22.2 No. 55, 6,000 operations 60° C
250 VAC	2	EN61058.1 T55 10,000 operations (Normally open or normally closed only)
250 VAC	0,5	EN61058.1 T55 50,000 operations (Change-over)
0-15 VDC	to be advised	General rating, 50,000 operations
15-30 VDC	to be advised	General rating, 50,000 operations
5 VDC	0,01	General rating, 1 million operations

X6

Operating Characteristics

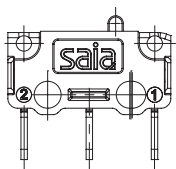
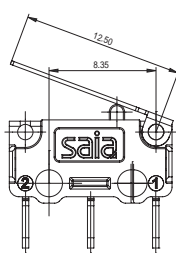
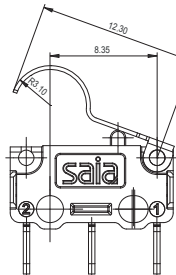
Actuator	Actuating Force Maximum		Release Force Minimum		Free Position		Operating Position Maximum		Movement Differential Maximum		Total travel Position *	
	(N)	(ozf)	(N)	(ozf)	(mm)	(in)	(mm)	(in)	(mm)	(in)	(mm)	(in)
Plunger 	1,5	5,4	0,2	0,72	6,2	0,24	5,5 ± 0,3	0,22 ± 0,012	0,2	0,01	5	0,02
J1-Lever  Width of lever 2,7	0,5	1,8	0,05	0,18	9,6	0,38	7,2 ± 1,5	0,28 ± 0,06	0,8	0,03	5,3	0,21
L0-Lever  Width of lever 2,7	0,65	2,34	0,1	0,36	11,2	0,44	9,6 ± 1,5	0,38 ± 0,06	0,8	0,03	8,1	0,32

Datum for Free Position and Operating Position: mounting holes.
* Flush with case. The case should not be used as an end stop.

Ordering Reference

Basic type	X6	Example: X6 G 3 03 K 1 A/A J1 1										
Operating Force	G	Standard 1,5 N										
Circuit	3 4 5	Change-over Normally closed Normally open										
Terminals	03 09 10 11	PCB 0.8 x 0.5 x 3.5 PCB 0.8 x 0.5 x 7.1 PCB formed to the left PCB formed to the right										
Case/Lid	K	Flame-retardant glass-fibre reinforced nylon										
Contact	1	AgNi										
Approvals	A A	cUL _{US} ENEC										
Actuators	J1 L0	No symbol, without lever Plain lever 12.3 mm Cam follower lever 12.3 mm										
Actuator position	2	Lever above terminal 1 Lever above terminal 2										
Special Features	/□□□□	Saia specialise in customer specific solutions. Additional product variants are available or can be provided. If your requirements cannot be satisfied from the options listed, please contact us.										